

Version
February 2014

Add-on Module

RF-STEEL

Plastic

**Plastic Design According to the
Partial Internal Forces Method (PIFM)**

Program Description

All rights, including those of translations, are reserved.

No portion of this book may be reproduced – mechanically, electronically, or by any other means, including photocopying – without written permission of DLUBAL SOFTWARE GMBH.

© **Dlubal Software GmbH**

Am Zellweg 2 D-93464 Tiefenbach

Tel.: +49 9673 9203-0

Fax: +49 9673 9203-51

E-Mail: info@dlubal.com

Web: www.dlubal.com

Contents

Contents		Contents			
1.	Introduction	4	7.	General Functions	38
1.1	Add-on Module RF-STEEL Plastic	4	7.1	Design Cases	38
1.2	RF-STEEL Plastic Team	5	7.2	Cross-Section Optimization	40
1.3	Using the Manual	6	7.3	Units and Decimal Places	42
1.4	Opening the RF-STEEL Plastic Module	6	7.4	Data Exchange	43
2.	Input Data	8	7.4.1	Exporting Materials to RFEM	43
2.1	General Data	8	7.4.2	Exporting Results	43
2.2	Materials	10	8.	Worked Examples	45
2.3	Cross-Sections	12	8.1	Doubly Symmetrical I-Section	45
3.	Calculation	16	8.1.1	Check of Allowable Bending Moment in Top Flange	47
3.1	Detail Settings	16	8.1.2	Check of the Allowable Axial Force	48
3.1.1	Settings	16	8.1.3	Check of the Allowable Bending Moment	49
3.1.2	General	17	8.2	Monosymmetrical I-Section	50
3.2	Design Methods	18	8.2.1	Transformation of Internal Forces	52
3.3	Start Calculation	20	8.2.2	Shear Resistance in Top Flange	53
4.	Results	21	8.2.3	Shear Resistance in Web	54
4.1	Design by Load Case	22	8.2.4	Shear Resistance in Bottom Flange	56
4.2	Design by Cross-Section	23	8.2.5	Check of Allowable Bending Moment in Top Flange	58
4.3	Design by Set of Members	24	8.2.6	Check of Allowable Bending Moment in Bottom Flange	59
4.4	Design by Member	25	8.2.7	Check of Allowable Bending Moment	60
4.5	Design by x-Location	25	8.3	Circular Hollow Section	62
4.6	Governing Internal Forces by Member	26	8.3.1	Check of Shear Resistance	63
4.7	Governing Internal Forces by Set of Members	27	8.3.2	Interaction of Normal and Bending Stresses	65
4.8	Parts List by Member	28	8.4	Rectangular Hollow Section	66
4.9	Parts List by Set of Members	29	8.4.1	Shear Resistance in Flanges	67
5.	Evaluation of Results	30	8.4.2	Shear Resistance in Web	69
5.1	Results on the RFEM model	31	8.4.3	Interaction of Normal and Bending Stresses	70
5.2	Result Diagrams	33	A	Literature	71
5.3	Filter for Results	34	B	Index	72
6.	Printout	36			
6.1	Printout Report	36			
6.2	Graphic Printout	36			

1. Introduction

1.1 Add-on Module RF-STEEL Plastic

A common way to design cross-sections is the elastic-plastic method. For the calculation of the internal forces S_d , linear elastic material behavior is assumed, for the calculation of the resistances R_d the elastic-perfectly plastic material behavior. Thus, the reserves of the cross-section are used, but the possibly existing plastic reserves of the system are not considered.

The ultimate limit state occurs when the limit internal forces in the fully plastic state are reached. It is necessary to verify that the internal forces under consideration of the interaction do not result in exceeding the limiting internal forces in the fully plastic state.

In RF-STEEL Plastic, the following design methods are available:

- Cross-sections consisting of three or two plates (I-, C-, Z-, L-sections, channels, tees), flat steel, pipes, and hollow sections according to the Partial Internal Forces Method (PIFM) with redistribution by KINDMANN/FRICKEL
- Elliptical cross-sections with analytic non-linear optimization procedure
- Simplex Method for general cross-sections.

For this design method, all combinations of internal forces are considered. The design ratio of each section is shown in the clearly-arranged tables and in the RFEM graphic, allowing you to infer the utilization of certain members at one glance. For each design section, detailed information on interaction (for example, the plastic internal forces) is shown.

If necessary, the module carries out an optimization of the cross-sections and exports the changed cross-sections to RFEM. Using the design cases, you can analyze separate structural components in complex structures or analyze variants.

RF-STEEL Plastic is an add-on module integrated in RFEM. Thus, the design-relevant input data is already preset when you start the module. After the design, you can evaluate the results in the graphical user interface of RFEM. Finally, the analyses can be documented in the global printout report, from determination of internal forces to design.

We hope you enjoy working with RF-STEEL Plastic.

Your DLUBAL Team

1.2 RF-STEEL Plastic Team

The following people were involved in the development of RF-STEEL Plastic:

Program coordination

Dipl.-Ing. Georg Dlubal

Dipl.-Ing. (FH) Younes El Frem

Programming

Ing. Zdeněk Kosáček

Mgr. Petr Oulehle

Dipl.-Ing. Georg Dlubal

Zbyněk Zámečník

Dr.-Ing. Jaroslav Lain

DiS. Jiří Šmerák

Ing. Martin Budáč

Cross-section and material library

Ing. Ph.D. Jan Rybín

Ing. Jiří Kubiček

Mgr. Petr Oulehle

Program design, dialog box figures, and icons

Dipl.-Ing. Georg Dlubal

Ing. Jan Milář

MgA. Robert Kolouch

Program testing

Dipl.-Ing. (FH) Steffen Clauß

Ing. Martin Hlavačka

Localization, manual

Ing. Fabio Borriello

Ing. Roberto Lombino

Ing. Dmitry Bystrov

Eng.º Nilton Lopes

Eng.º Rafael Duarte

Mgr. Ing. Hana Macková

Ing. Jana Duníková

Ing. Téc. Ind. José Martínez

Dipl.-Ing. (FH) René Flori

MA Translation Anton Mitleider

Ing. Lara Freyer

Dipl.-Ü. Gundel Pietzcker

Alessandra Grosso

Mgr. Petra Pokorná

Bc. Chelsea Jennings

Ing. Michaela Prokopová

Jan Jeřábek

Ing. Marcela Svitáková

Ing. Ladislav Kábrt

Dipl.-Ing. (FH) Robert Vogl

Ing. Aleksandra Kociołek

Ing. Marcin Wardyn

Technical support and final testing

M.Eng. Cosme Asseya

Dipl.-Ing. (FH) Ulrich Lex

Dipl.-Ing. (BA) Markus Baumgärtel

Dipl.-Ing. (BA) Sandy Matula

Dipl.-Ing. Moritz Bertram

Dipl.-Ing. (FH) Alexander Meierhofer

Dipl.-Ing. (FH) Steffen Clauß

M.Eng. Dipl.-Ing. (BA) Andreas Niemeier

Dipl.-Ing. Frank Faulstich

M.Eng. Dipl.-Ing. (FH) Walter Rustler

Dipl.-Ing. (FH) René Flori

M.Sc. Dipl.-Ing. (FH) Frank Sonntag

Dipl.-Ing. (FH) Stefan Frenzel

Dipl.-Ing. (FH) Christian Stautner

Dipl.-Ing. (FH) Walter Fröhlich

Dipl.-Ing. (FH) Lukas Sühnel

Dipl.-Ing. (FH) Bastian Kuhn

Dipl.-Ing. (FH) Robert Vogl

1.3 Using the Manual

Topics like installation, graphical user interface, results evaluation, and printout are described in the manual of the main program RFEM. The present manual focuses on typical features of the RF-STEEL Plastic add-on module.



The descriptions in this manual follow the sequence and structure of the module's input and results windows. In the text, the **buttons** are given in square brackets, for example [View mode]. At the same time, they are pictured on the left. The **Expressions** that appear in dialog boxes, windows, and menus are set in *italics* to clarify the explanations.

At the end of the manual, you find the index. If you still cannot find what you are looking for, please check our website www.dlubal.com where you can go through the FAQ pages and find a solution by using various filter criteria.

1.4 Opening the RF-STEEL Plastic Module

In RFEM, you have the following possibilities to start the add-on module RF-STEEL Plastic.

Menu

To open the add-on module, you can select in the RFEM menu

Add-on Module → Design - Steel → RF-STEEL Plastic.

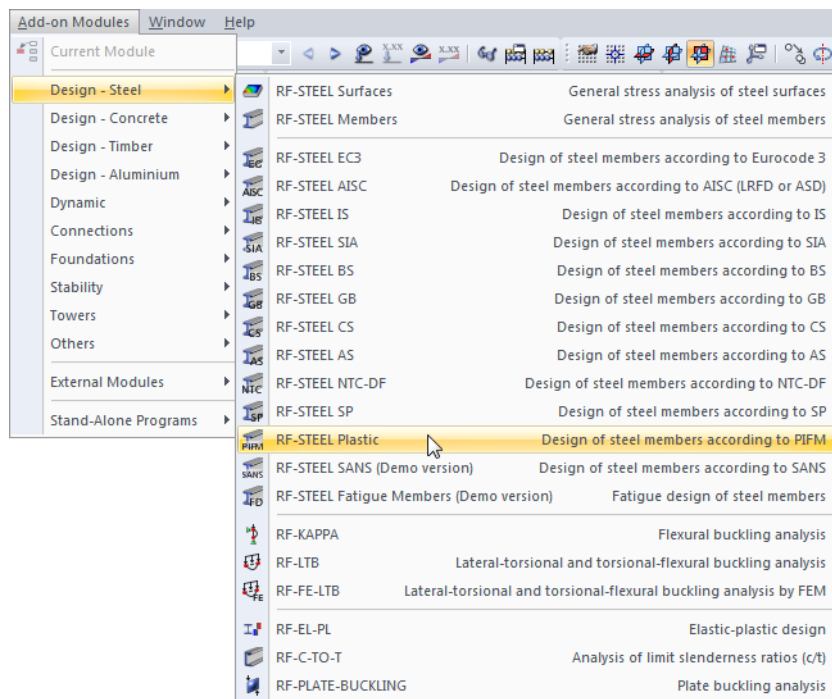

Figure 1.1: Menu: Add-on Module → Design - Steel → RF-STEEL Plastic

Navigator

Alternatively, you can start the add-on module in the *Data* navigator by clicking

Add-on Modules → RF-STEEL Plastic.

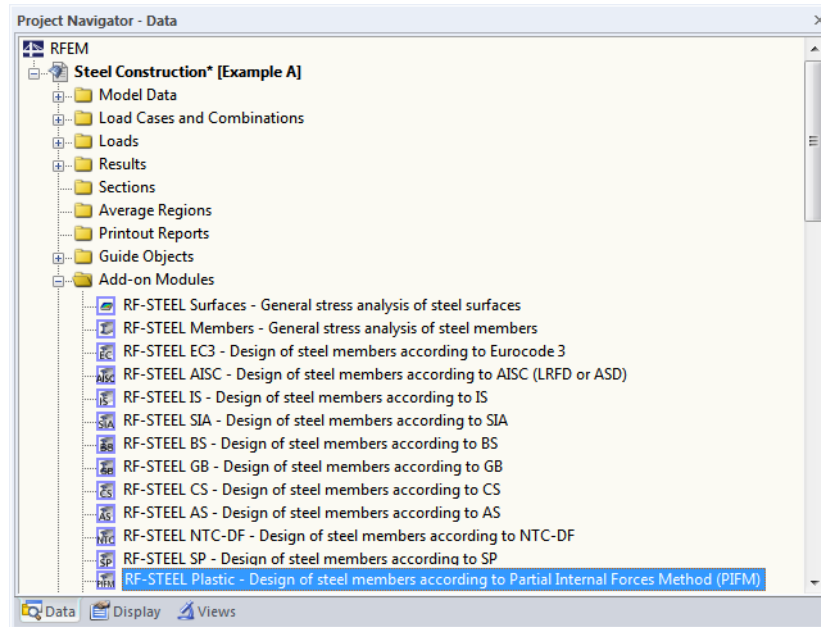

Figure 1.2: Data navigator: Add-on Module → RF-STEEL Plastic

Panel

If results from RF-STEEL Plastic are already available in the RFEM model, you can also open the design module from the panel:

First, set the relevant RF-STEEL Plastic design case in the load case list of the RFEM toolbar. Then, click the [Show Results] button to graphically show the design criterion on the members.

If the results display is activated, the panel is available, too. Now you can click [RF-STEEL Plastic] in the panel to open the module.

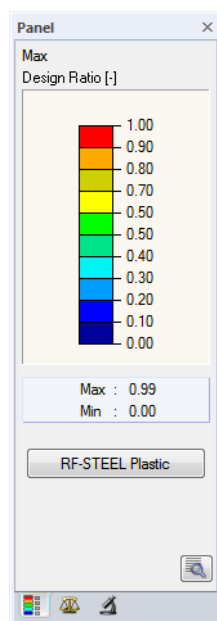
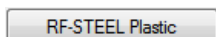
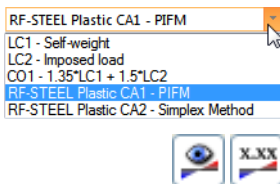

Figure 1.3: Panel button [RF-STEEL Plastic]

2. Input Data

When you start the add-on module, a new window opens. In this window, a navigator is displayed on the left that manages the available input and output windows. The drop-down list above the navigator contains the design cases (see Chapter 7.1, page 38).

The design-relevant data is defined in several input windows. When you open RF-STEEL Plastic for the first time, the following parameters are imported automatically:

- Members and sets of members
- Load cases, load combinations, and result combinations
- Materials
- Cross-sections
- Internal forces (in the background, if calculated).

To select a window, click the corresponding entry in the navigator. To go to the previous or next window, use the buttons shown on the left. You can also use the function keys to select the next [F2] or previous [F3] window.

To save the results, click [OK]. Thus, you exit RF-STEEL Plastic and return to the main program. To exit the module without saving the new data, click [Cancel].



2.1 General Data

In the 1.1 *General Data* window, you select the members, sets of members, and actions that you want to analyze. The tabs manage the load cases, load combinations, and result combinations for the various checks.

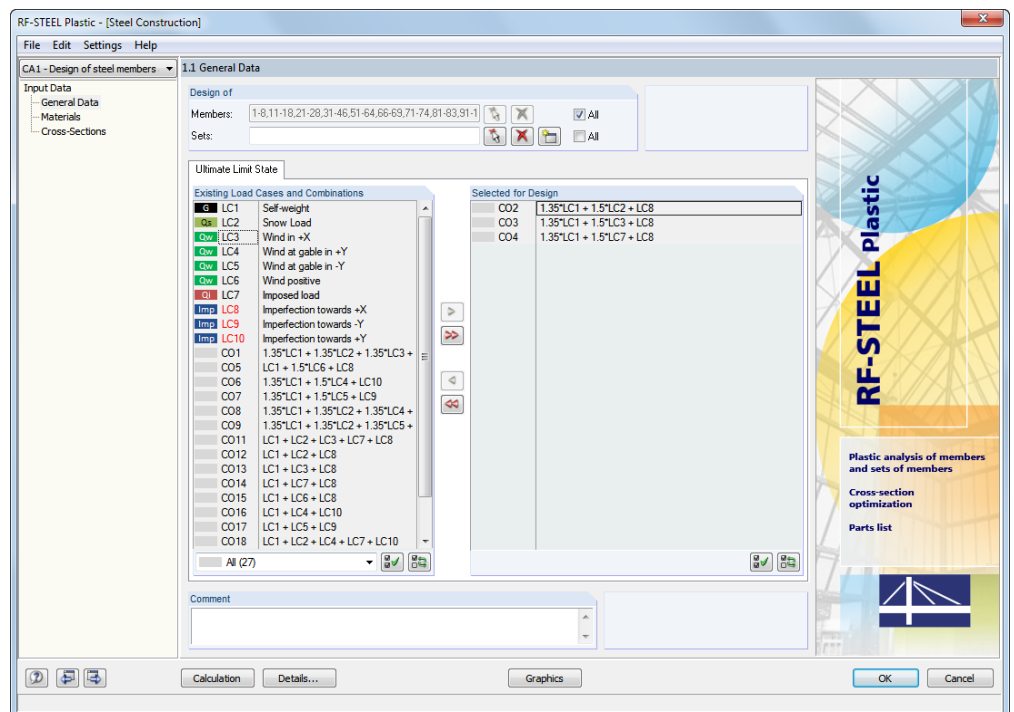

Figure 2.1: Window 1.1 *General Data*

Design of

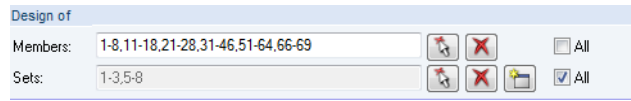

Figure 2.2: Design of members and sets of members



The design can be carried out for *Members* as well as for *Sets of Members*. If you want to design only particular objects, clear the *All* check box. Now you can access the text boxes to enter the numbers of the relevant members or sets of members. To select the list of the preset numbers, double-click in the text box and overwrite the list by manually entering the numbers. Alternatively, you can select the objects graphically in the RFEM work window upon clicking [↖].

When you design a set of members, the program determines the extreme values of all members contained in the set of members. The according results are shown in the results windows 2.3 *Design by Set of Members*, 3.2 *Governing Internal Forces by Set of Members*, and 4.2 *Parts List by Set of Members*.



To define a new set of members, click [New]. The dialog box already known from RFEM appears where you can specify the parameters for a set of members.

Ultimate Limit State - Existing Load Cases and Combinations

This dialog box section contains all load cases, load combinations, and result combinations created in RFEM.



To transfer the selected entries to the *To Design* section, click [▶]. Alternatively, you can just double-click the entries. The [▶▶] button transfers the complete list to the right.



To transfer multiple entries at once, select them while pressing the [Ctrl] key, as common in Windows applications.

If a load case is highlighted in red, for example LC 8-10 in Figure 2.1, it means that it cannot be designed. This happens when the load cases are defined without any load data or contain only imperfections. When you transfer such a load case, a corresponding warning appears.

At the end of the list, several filter options are available. They will help you assign the entries sorted according to load cases, load combinations, or action categories. The buttons have the following functions:

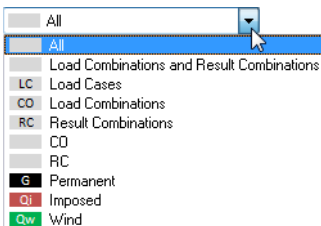



	Selects all cases in the list
	Inverts selection of load cases

Table 2.1: Buttons in the tab *Ultimate Limit State*

Ultimate Limit State - Selected for Design

The section on the right contains the load cases, load combinations, and result combinations selected for design. To remove selected entries from the list, click [◀] or double-click the entries. To transfer the entire list to the left, click [◀◀].

The design of an enveloping max/min result combination is performed faster than the design of all available load cases and load combinations. However, the influence of the contained load cases and load combinations is difficult to discern.

Comment

In this text box, you can type user-defined notes describing, for example, the current design case.



Result combination

2.2 Materials

The window is subdivided into two parts. The upper part lists all materials created in RFEM. The *Material Properties* dialog box section shows the properties of the current material, that is, the table row currently selected in the upper section.

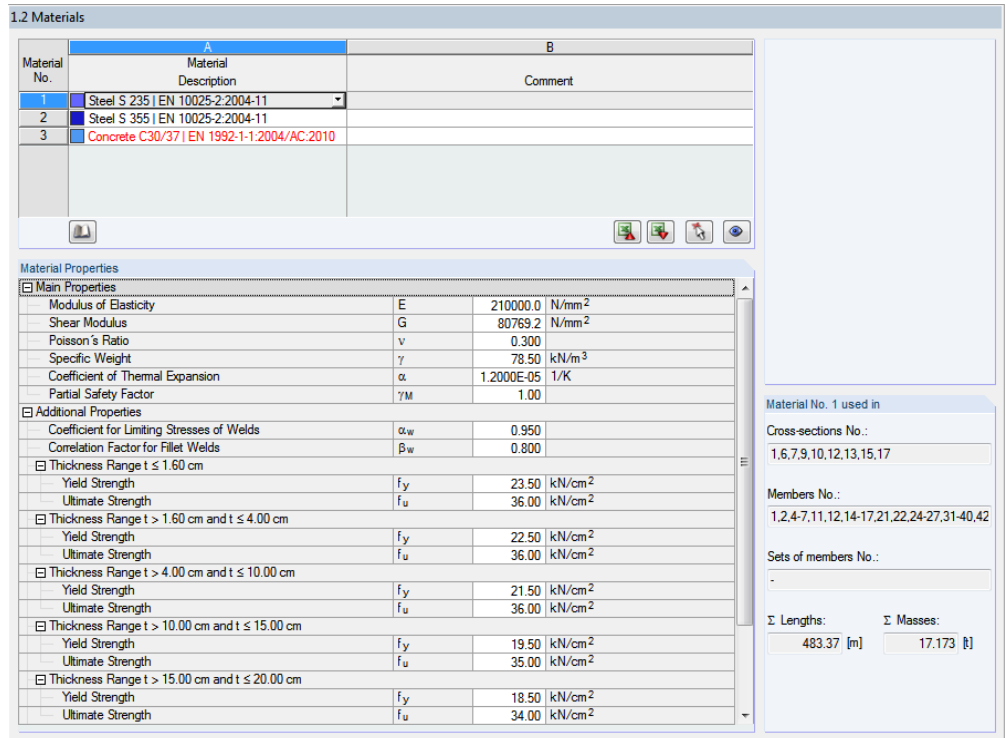

Figure 2.3: Window 1.2 Materials

Materials that will not be used in the design are displayed in grey, materials that are not allowed in red, and modified materials in blue.

The material properties required for the determination of internal forces are described in Chapter 4.3 of the RFEM manual (*Main Properties*). The material properties required for design are stored in the global material library. These values are preset (*Additional Properties*).

To adjust the units and decimal places of material properties and stresses, select in the module's menu

Settings → **Units and Decimal Places** (see Chapter 7.3, page 42).

Material Description

The materials defined in RFEM are preset but can be changed at any time. To do this, click the material in column A. Then, click [▼] or press function key [F7] to open the material list.

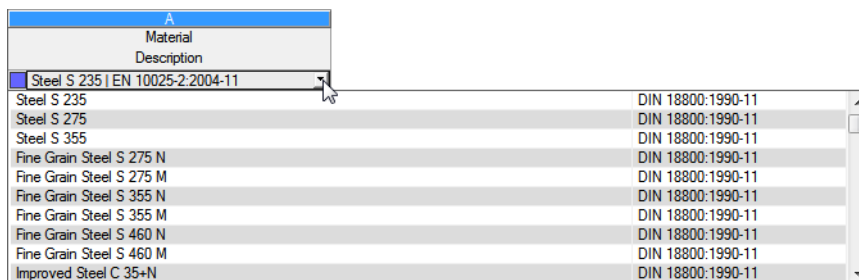

Figure 2.4: List of materials

You can select only materials from the "Steel" category.

After you import a material, the design relevant *Material Properties* are updated.

If you change the material description manually and your entry is stored in the material library, RF-STEEL Plastic will import the material properties, too.

It is principally not possible to edit the material properties in RF-STEEL Plastic.

Material Library

Numerous materials are already available in the library. To open the library, select

Edit → Material Library

or use the button shown on the left.

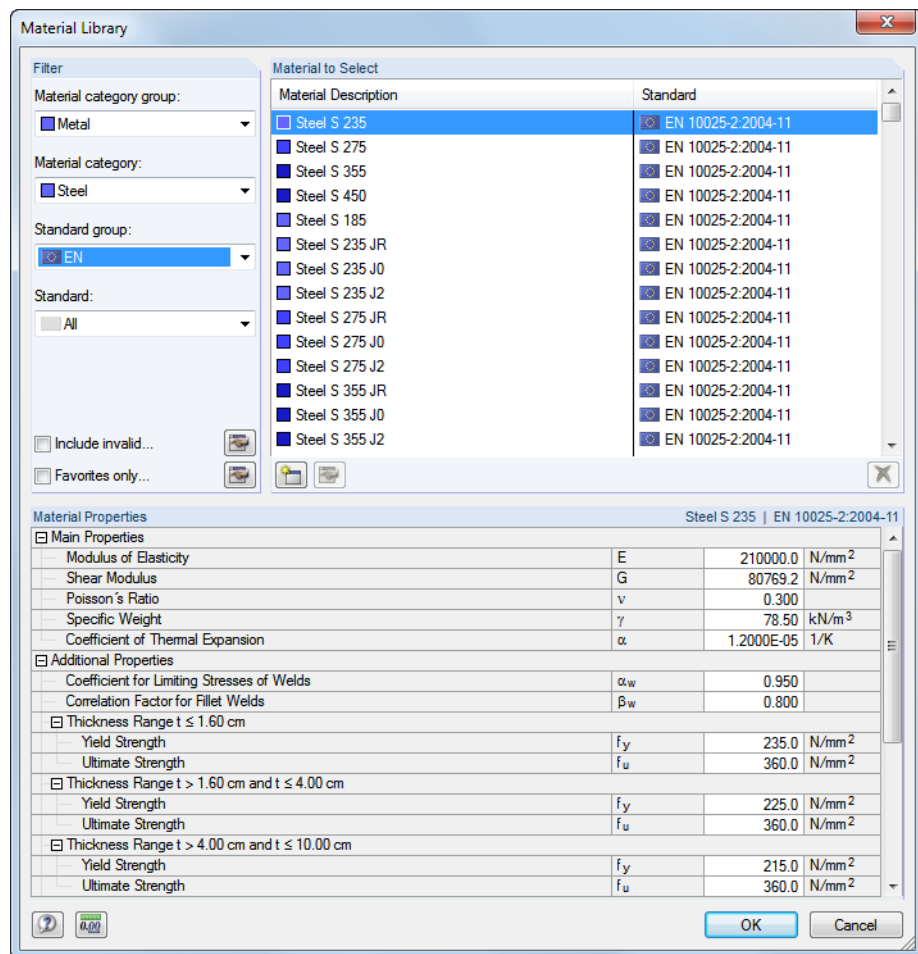
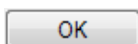

Figure 2.5: Dialog box *Material Library*

In the *Filter* section, *Steel* is preset as the material category. Select the relevant steel grade for design in the *Material to Select* list. You can check the corresponding properties in the section below.



To transfer the selected material to Window 1.2 of RF-STEEL Plastic, click [OK] or [↵].

Chapter 4.3 of the RFEM manual describes how to filter, add, or rearrange materials.

2.3 Cross-Sections

This window manages the cross-sections that are used for the design. In addition, you can specify optimization parameters in this window.

1.3 Cross-Sections

Section No.	A Material No.	B Cross-Section Description	C Cross-Section Type	D Optimize	E Remark	F Comment
1	1	HE A 400	I-section	From Current Flow	2)	
2	2	IS 360/170/8/14/0	I-section	No		
3	2	IS 500/170/8/14/0	I-section	No		
6	1	HE A 160	I-section	No		
7	1	HE A 120	I-section	No	5)	
9	1	IPE 360	I-section	No		
10	1	HE A 140	I-section	No		
12	1	QRO 80x4	Box	No		
13	1	RD 24	Round bar	No		
15	1	HE A 200	I-section	No		
16	3	Rectangle 200/200	Invalid	No	5)	
17	1	IPE 360	I-section	No		

2) The cross-section will be optimized, utilizing the best section from the table.

Cross-Section Properties - HE A 400

Cross-Section Type	I-section	
Cross-Sectional Area	A	159.00 cm ²
Effective Shear Area	A _{v,y}	95.00 cm ²
Effective Shear Area	A _{v,z}	38.63 cm ²
Moment of Inertia	I _y	45070.00 cm ⁴
Moment of Inertia	I _z	8560.00 cm ⁴
Torsional Constant	I _t	190.00 cm ⁴
Radius of Gyration	i _y	168.0 mm
Radius of Gyration	i _z	73.4 mm
Elastic Section Modulus	S _{el,y}	2310.00 cm ³
Elastic Section Modulus	S _{el,z}	571.00 cm ³
Plastic Section Modulus	W _{pl,y}	2560.00 cm ³
Plastic Section Modulus	W _{pl,z}	872.86 cm ³
Warping Constant of Cross-Section	I _w	2942000.00 cm ⁶
Statical Moment	Q _y	1280.00 cm ³
Statical Moment	Q _z	213.75 cm ³

Cross-section No. 1 used in

Members No.:
1,2,11,12,21,22,31,32,39,40

Sets of members No.:
-

Σ Lengths: 48.00 [m] Σ Masses: 5.991 [t]

Material:
1 - Steel S 235

Figure 2.6: Window 1.3 Cross-Sections

Cross-Section Description

The cross-sections defined in RFEM are preset together with the assigned material numbers.

To change a cross-section, click the entry in column B, thus selecting this box. To open the cross-section table of the current cross-section box, click [Cross-Section Library] or [...] in the box or press the function key [F7] (see the following figure).

In this dialog box, you can select a different cross-section or a different cross-section table. To select a different cross-section category, click [Back to cross-section library]. The general cross-section library opens.

Chapter 4.13 of the RFEM manual describes how to select cross-sections from the library.



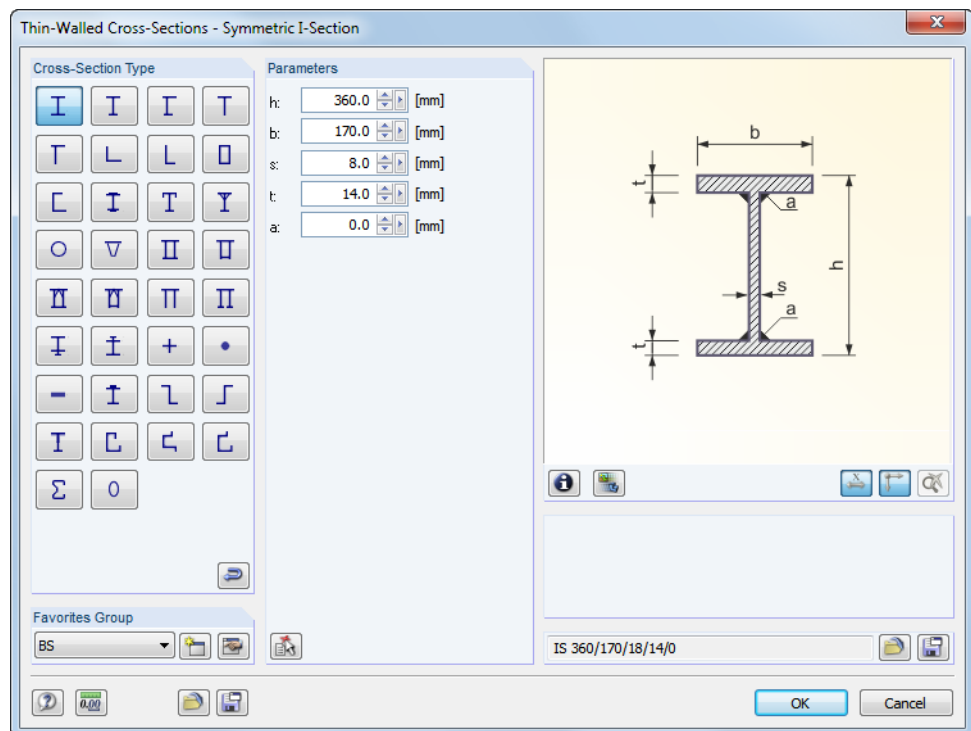
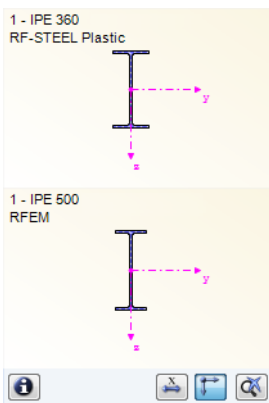

Figure 2.7: IS cross-sections in the cross-section library



You can also enter the new cross-section description in the cross-section box directly. If the data base contains the entry, RF-STEEL Plastic imports the according cross-section parameters, too.

A modified cross-section is highlighted in blue.

If cross-sections specified in RF-STEEL Plastic are different from the ones used in RFEM, both cross-sections are displayed in the graphic on the right. The designs are carried out with the internal forces from RFEM for the cross-section selected in RF-STEEL Plastic.

Cross-Section Type

The cross-section type is decisive for the design method (see Chapter 3.2, page 18):

- Cross-sections consisting of three or two plates (I-, C-, Z-, L-sections, channels, tees), flat steel, pipes, and hollow sections: Partial Internal Forces Method with redistribution by KINDMANN/FRICHEL
- Elliptical cross-sections: analytical nonlinear optimization method
- General cross-sections: Simplex Method.

Max. Design Ratio

This table column is displayed only after the calculation. It serves as a decision support for the optimization. By means of the design ratio and colored relation scales, you can see which cross-sections are little utilized and thus oversized, or overstressed and thus undersized.

Optimize

Each allowable cross-section can undergo an optimization process. For the RFEM internal forces, the program searches the cross-section that comes as close as possible to a user-defined maximum design ratio. This ratio can be specified in the *General* tab of the *Details* dialog box (see Figure 3.2, page 17).

To optimize a cross section, open the drop-down list in column D or E and select the relevant entry: *From current row* or, if available, *From favorites 'Description'*. Recommendations for the cross-section optimization can be found in Chapter 7.2, page 40.

Remark

This column shows remarks in the form of footers that are described in detail below the cross-section list.



A warning might appear before the calculation: *Incorrect type of cross-section No. XX*. This means that there is a cross-section that is not registered in the data base. This can be a user-defined cross-section or a SHAPE-THIN cross-section that has not been calculated yet. To select an appropriate cross-section for design, click [Library] (see description after Figure 2.6).

Member with Tapered Cross-Section

For tapered members with different cross-sections at the start and end, the module displays both cross-section numbers in two rows, in accordance with the definition in RFEM.

RF-STEEL Plastic also designs tapered members, provided that the cross-section at the start of the member has the same number of stress points as the cross-section at the end of the member. For example, the normal stresses are determined from the moments of inertia and the distances of the stress points from the center of gravity. If the cross-sections at the start and the end of a tapered member have a different number of stress points, the intermediate values cannot be interpolated. The calculation is possible neither in RFEM nor in RF-STEEL Plastic.



The cross-section's stress points including numbering can also be checked graphically. To do this, select the cross-section in Window 1.3, and then click [Info]. The dialog box shown in Figure 2.8 appears.

Info About Cross-Section



In the *Info About Cross-Section* dialog box, you can view the cross-section properties, stress points, and c/t-parts.

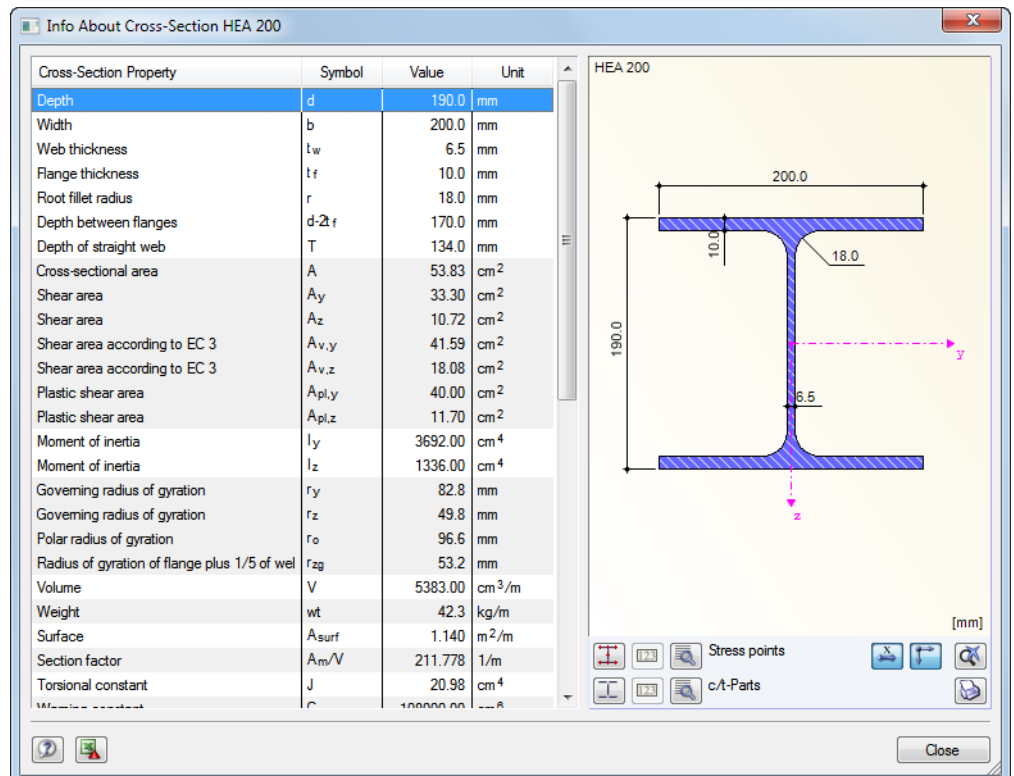

Figure 2.8: Dialog box *Info About Cross-Section*

The right part of the dialog box shows a graphic of the currently selected cross-section.

The buttons below the graphic have the following functions:







Button	Function
	Displays or hides the stress points
	Displays or hides the c/t-parts
	Displays or hides the numbers of stress points or c/t-parts
	Displays or hides details of the stress points or c/t-parts (see Figure 2.9)
	Displays or hides the dimensions of the cross-section
	Displays or hides the main axes of the cross-section
	Resets the full view of the cross-section graphic

Table 2.2: Buttons of the cross-section graphic



By means of the [Details] button, you can call up detailed information on stress points (distances to center of gravity, statical moments of area, normalized warping constants, etc.) and c/t-parts.

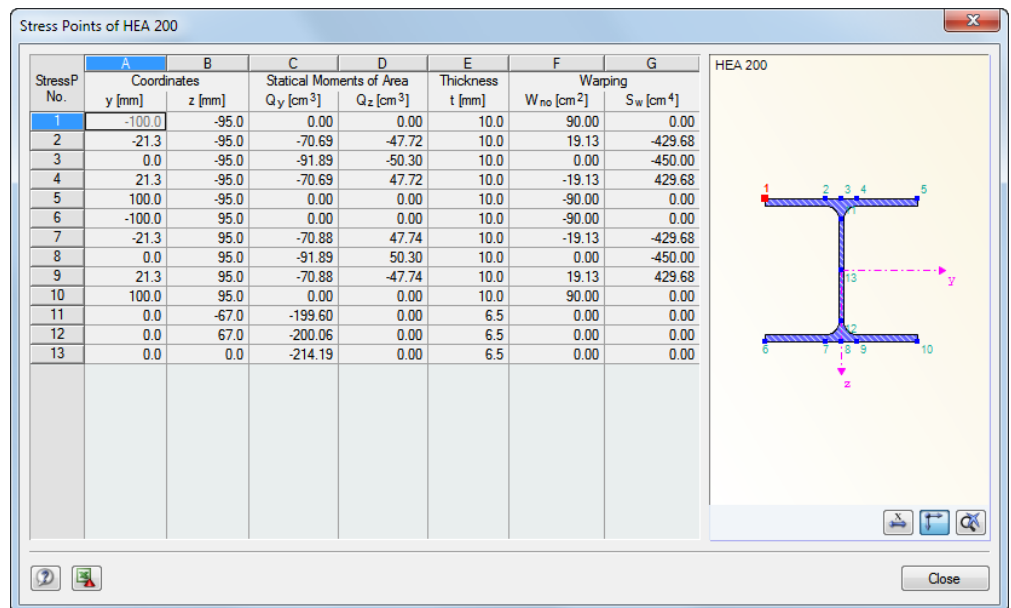

Figure 2.9: Dialog box *Stress Points of HEA 200*

3. Calculation

3.1 Detail Settings

Calculation

Details...

Before starting the [Calculation], you should check the design details. To open the corresponding dialog box, use the [Details] button available in every window of the add-on module.

The *Details* dialog box contains the following tabs:

- Settings
- General
- Used Literature.

3.1.1 Settings

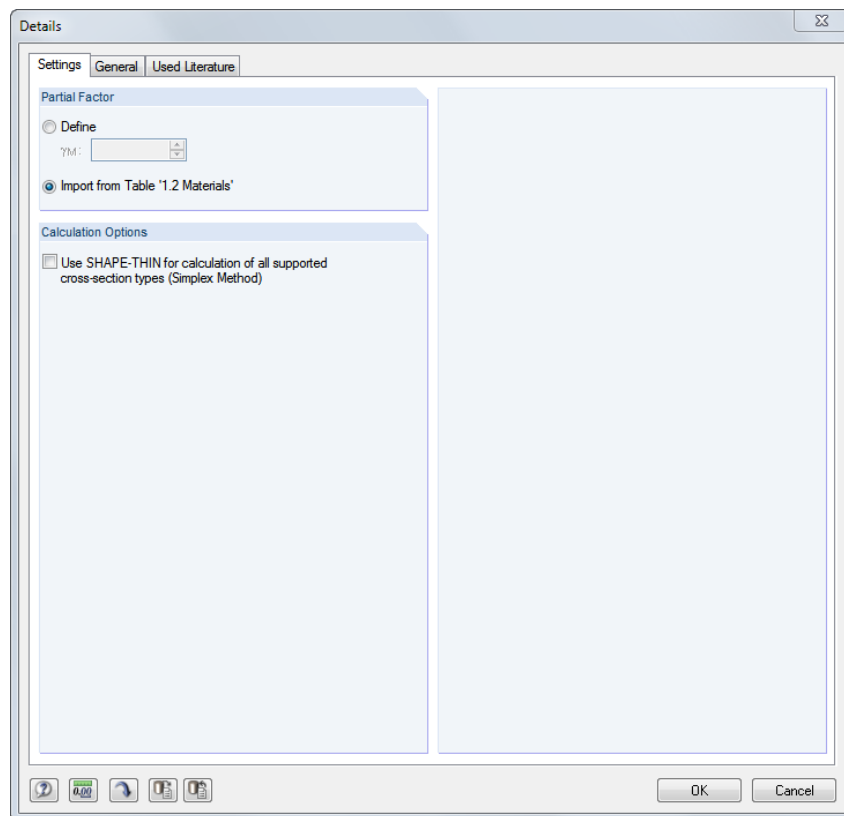

Figure 3.1: Dialog box *Details*, tab *Settings*

Partial Safety Factor

For the determination of the resistances R_d , the partial safety factor γ_M of the material is usually to be considered. If you *Define* this factor manually, it is applied globally for all materials of the design case. By default, however, the partial safety factors are taken separately for each material from the properties defined in the 1.2 *Materials* window.

Calculation Options

Cross-sections consisting of two or three plates (I-, C-, Z-, L-sections, channels, tees) are calculated according to the PIFM with redistribution according to [1], elliptical cross-sections according to the non-linear optimization method. By selecting the check box, you can calculate these cross-section types also according to the Simplex Method (see Chapter 3.2), which is usually used only for general cross-sections.

3.1.2 General

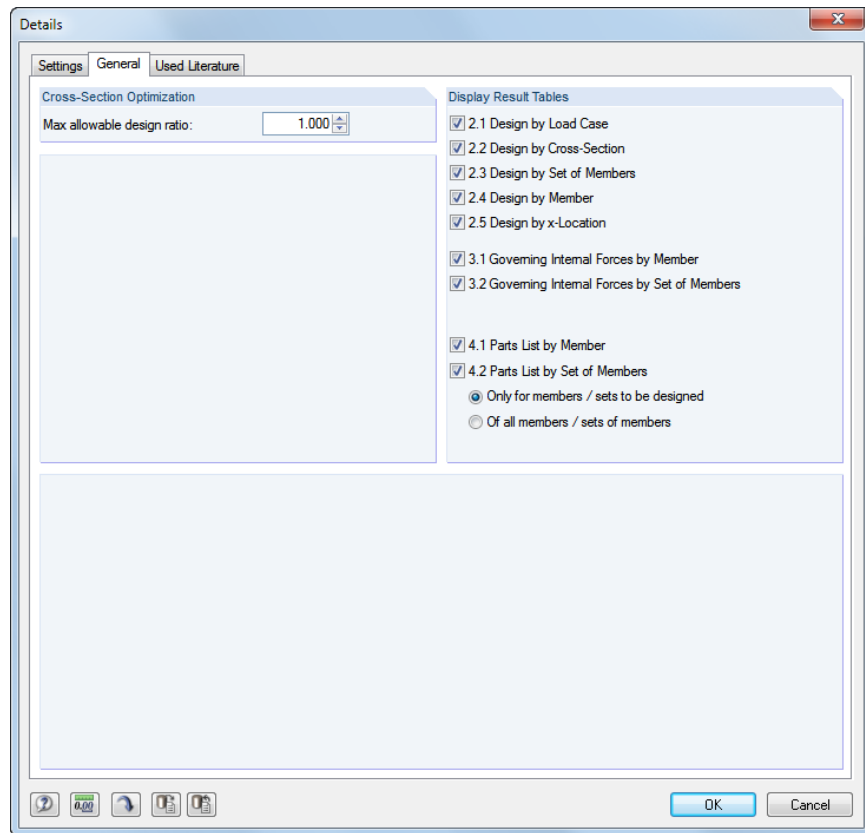

Figure 3.2: Dialog box *Details*, tab *General*

Cross-Section Optimization

The optimization is targeted on the maximum design ratio of 100 %. If necessary, you can also specify a different upper limit in the text box.

Display Result Tables

Here, you can select which results windows and parts list you want to display. These windows are described in Chapter 4 *Results*.

3.2 Design Methods

Depending on the cross-section type, one of the following methods is used.

Partial Internal Forces Method (PIFM)

According to the PIFM with redistribution by KINDMANN/FRICKEL [1], you can design cross-sections consisting of two or three plates: top flange, web and, if available, bottom flange. The flanges must be arranged horizontally, the web vertically. In this way, the most frequently used cross-sections are considered.

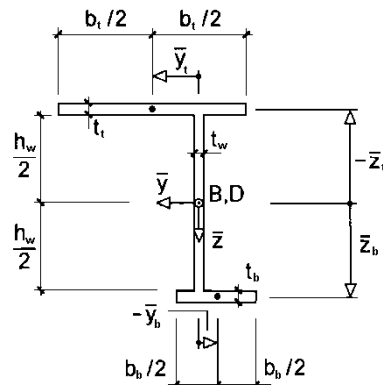

Figure 3.3: General cross-section consisting of three plates (horizontal-vertical-horizontal)

If the top or bottom flange is left out, you can consider cross-sections consisting of two plates like tees or L-sections.

The method by KINDMANN/FRICKEL allows you to design flat steel sections, pipes, and hollow sections. The calculation methods are described in [1], Chapter 10.



In Chapter 8 of this manual, you find worked examples for various sections analyzed according to the PIFM.

Plastic interaction relations for elliptical cross-sections

The plastic interaction relations for elliptical cross-sections according to NOWZARTASH/MOHAREB are described in [2]. An analytical nonlinear optimization method is used to analyze the plastic capacity of elliptical hollow sections.

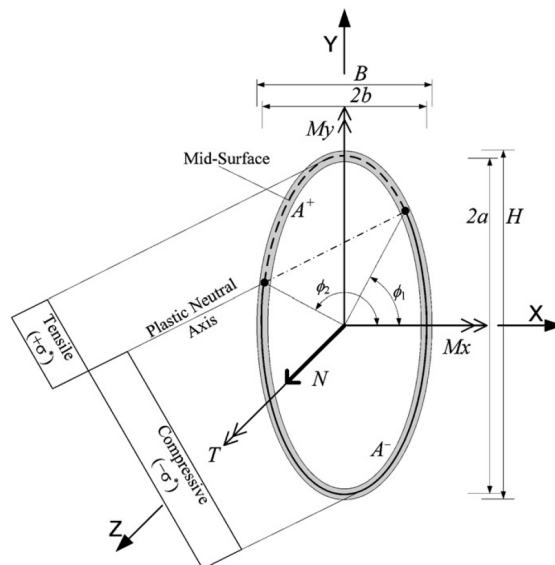

Figure 3.4: Elliptical hollow sections with interaction from axial force, torsion, and double bending according to [2]

Simplex Method

For a linear optimization problem, the cross-section is discretized into a finite number of surface elements that are as small as possible. If all internal forces of an x-location are consistently multiplied by a factor, the plastic capacity is found for a certain value. A combination of internal forces can be described by means of the following vector:

$$F = \{N, M_u, M_v, V_u, V_v, M_T\}$$

In the calculation of the plastic resistance, a constant ratio of the components is assumed in this vector, so that the factor enlarges the internal force vector F up until the yield area. The factor is determined as the maximum of a linear optimization problem using a revised simplex algorithm. With the yield conditions according to VON MISES, we obtain a coordinate plane of normal and shear stresses of an ellipse which is approximated by an inscribed octagon.

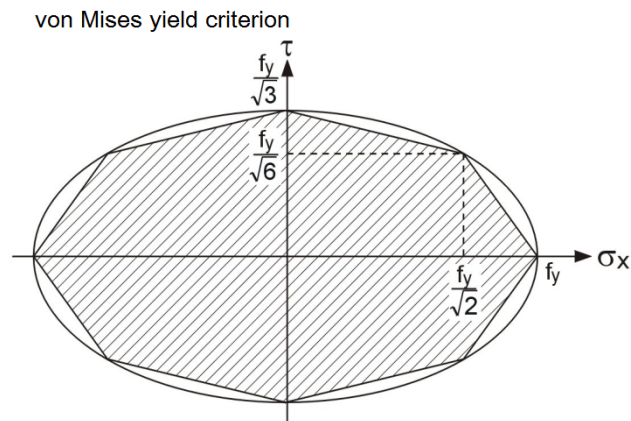

Figure 3.5: Linear approximation of the yield criterion

With this method, you can analyze general cross-sections with thin-walled element thicknesses. They are also used in the cross-section program SHAPE-THIN (see [3]).

Details...

The *Details* dialog box allows you to calculate the cross-sections consisting of two or three plates and hollow sections according to the Simplex Method (see Figure 3.1, page 16).

3.3 Start Calculation

Calculation

To start the calculation in RF-STEEL Plastic, use the [Calculation] button available in every input window of the module.

RF-STEEL Plastic searches for the results of the load cases, load combinations, and result combinations selected for design. If no results can be found, the program starts the RFEM calculation to determine the design-relevant internal forces.

You can also start the calculation in the RFEM user interface. To do this, use the *To Calculate* dialog box (menu *Calculation* → *To Calculate*), containing design cases as well as load cases or load combinations.

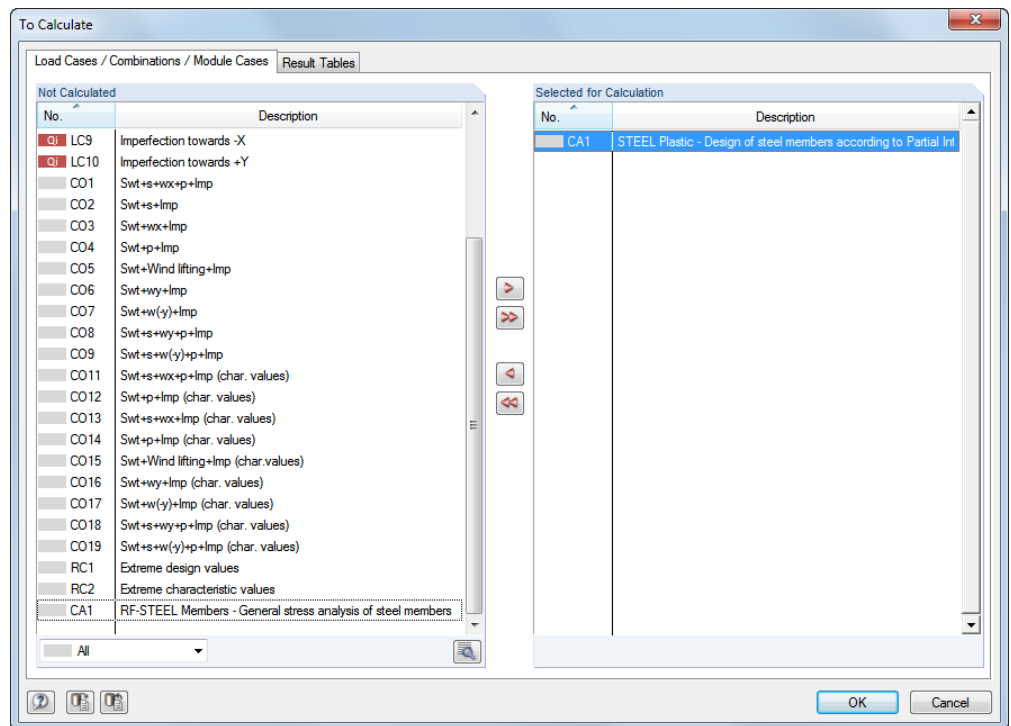

Figure 3.6: Dialog box *To Calculate*

If the RF-STEEL Plastic cases are missing in the *Not Calculated* list, select *All* or *Add-on Modules* in the drop-down list at the end of the dialog box section.

To transfer the selected RF-STEEL Plastic case to the section on the right, click [▶]. Click [OK] to start the calculation.

Alternatively, you can start the calculation of a design case by using the drop-down in the toolbar. In this list, select the RF-STEEL Plastic case, and then click [Show Results].

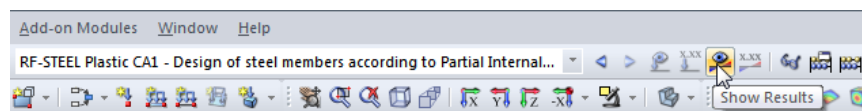
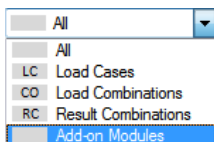

Figure 3.7: Direct calculation of an RF-STEEL Plastic case in RFEM

Subsequently, you can observe the design process in a separate dialog box.



4. Results

Immediately after the calculation, the 2.1 *Design by Load Case* window is shown.

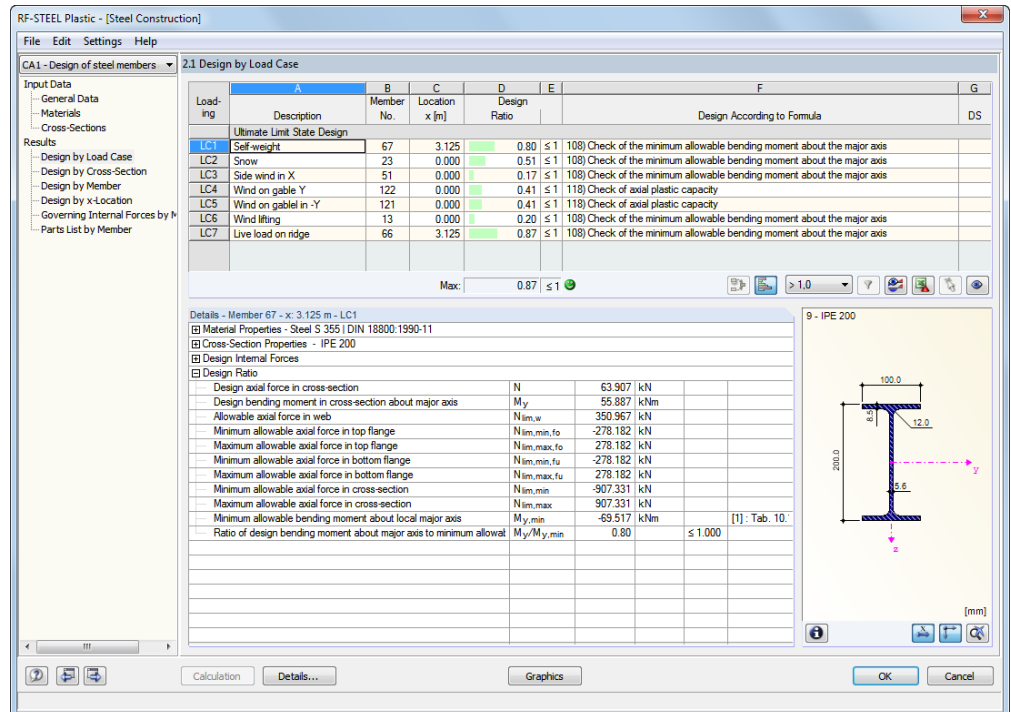

Figure 4.1: Results window with designs and intermediate values

The designs are shown in the results windows 2.1 through 2.5, sorted by different criteria.

Windows 3.1 and 3.2 show the governing internal forces. Windows 4.1 and 4.2 show the parts lists by members and sets of members.



To open a window, click the corresponding entry in the navigator. To go to the previous or next input window, use the buttons shown on the left. Alternatively, you can use the function keys to go the next [F2] or previous [F3] window.

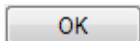

Click [OK] to save the results. Thus you exit RF-STEEL Plastic and return to the main program.

Chapter 4 *Results* describes the different results windows one by one. Chapter 5 *Evaluation* describes evaluating and checking results, page 30 f.

4.1 Design by Load Case

The upper part of the window shows a summary of the governing checks sorted by load case, load combination, and result combination.

The lower part provides detailed information about the cross-section properties, design internal forces, and check parameters for the load case selected above.

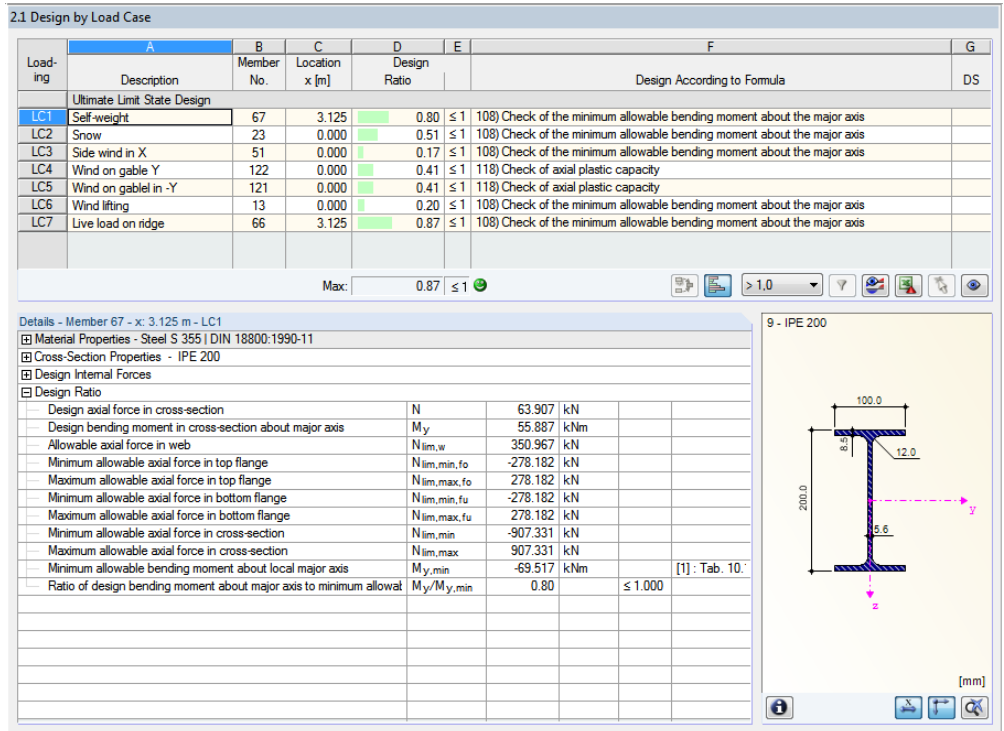

Figure 4.2: Window 2.1 *Design by Load Case*

Description

This column shows the descriptions of the load cases, load combinations, and result combinations used for the designs.

Member No.

This column shows the number of the member with the maximum design ratio of the analyzed loading.

Location x

This column shows the corresponding x-location where the member's maximum design ratio occurs. For the table output, the program uses the following member locations x:

- Start and end node
- Division points according to possibly defined member division (see RFEM Table 1.16)
- Member division according to specification for member results (RFEM dialog box *Calculation Parameters*, tab *Global Calculation Parameters*)
- Extreme values of the internal forces.

Design

Columns D and E show the design conditions

The length of the color scale represents the respective stress ratio.

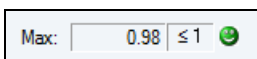

Design According to Formula

This column shows the equations of the standard used in the checks.

4.2 Design by Cross-Section

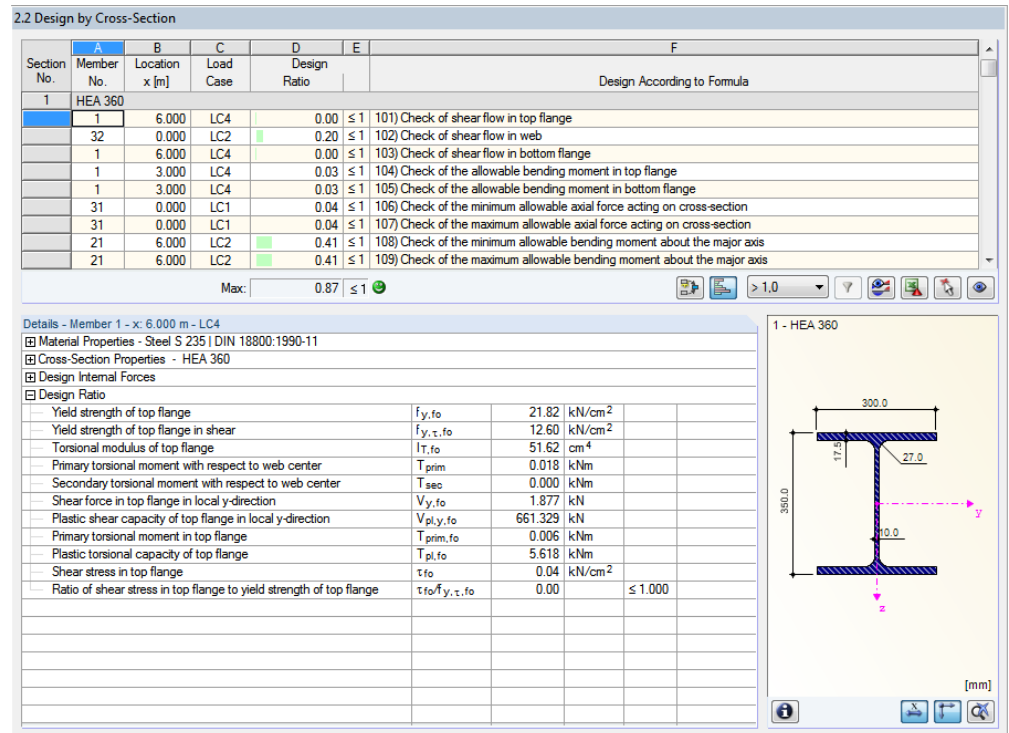

Figure 4.3: Window 2.2 Design by Cross-Section

This window shows the maximum design ratios of all members and actions selected for design, sorted by cross-section.

If there is a tapered member, both cross-section descriptions are displayed in the table row next to the section number.

4.3 Design by Set of Members

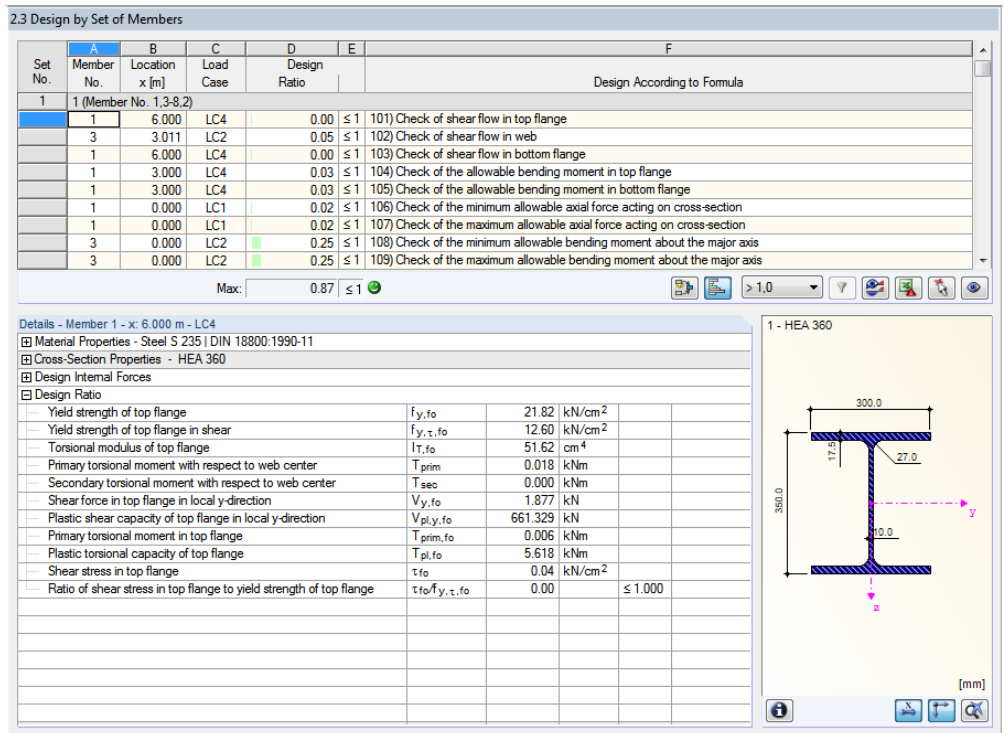

Figure 4.4: Window 2.3 Design by Set of Members

This results window is displayed if you have selected at least one set of members for design. The window lists the maximum design ratios sorted by set of members.

The *Member No.* column shows the number of the one member within the set of members that bears the maximum ratio for the respective design criterion.

The output by set of members allows you to clearly present the design for an entire structural group (for example, a frame).

4.4 Design by Member

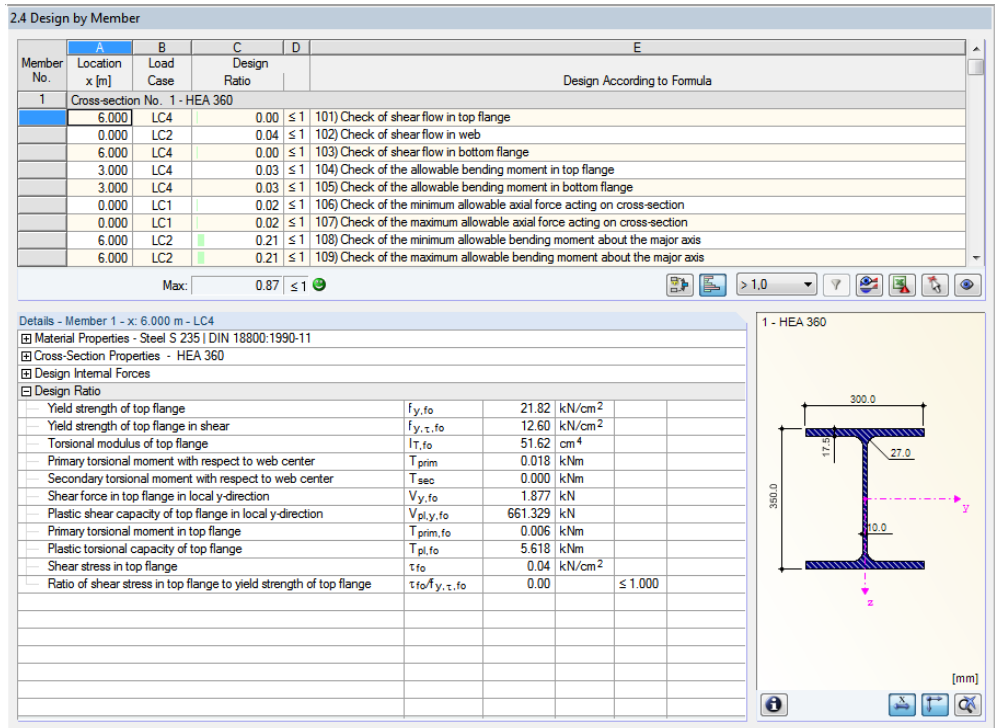

Figure 4.5: Window 2.4 Design by Member

This results window shows the maximum design ratios for the individual designs sorted by member number. The columns are described in detail in Chapter 4.1, page 22.

4.5 Design by x-Location

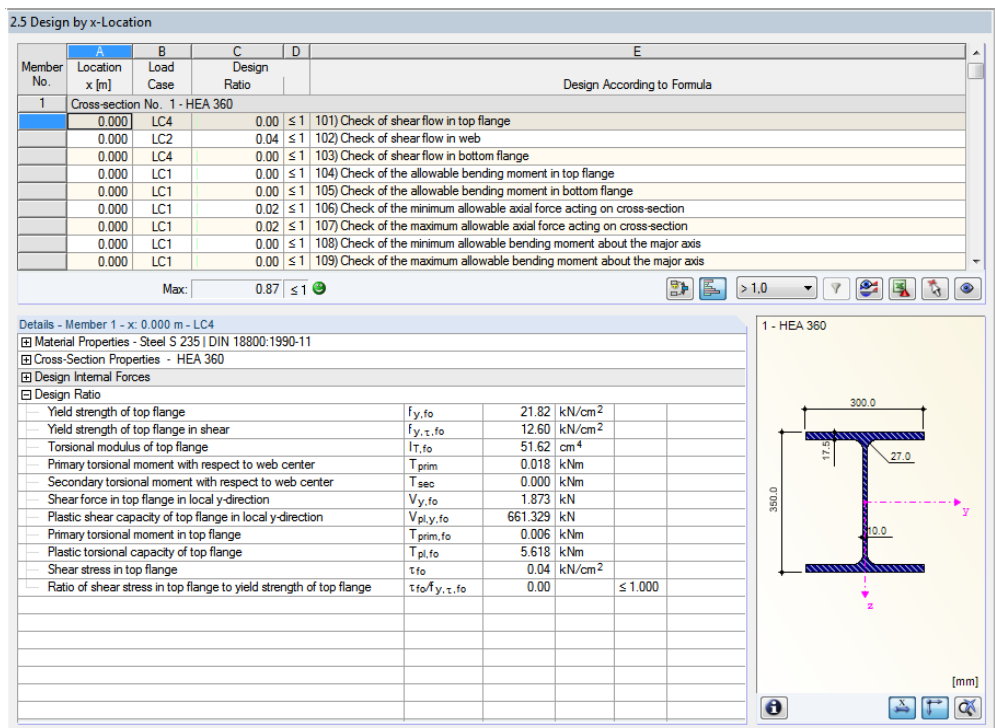

Figure 4.6: Window 2.5 Design by x-Location

This results window lists the maxima for each member at the locations *x* resulting from the division points in RFEM:

- Start and end node
- Division points according to possibly defined member division (see RFEM Table 1.16)
- Member division according to specification for member results (RFEM dialog box *Calculation Parameters*, tab *Global Calculation Parameters*)
- Extreme values of the internal forces.

4.6 Governing Internal Forces by Member

3.1 Governing Internal Forces by Member									
Member No.	Location x [m]	Load- ing	Forces [kN]			Moments [kNm]			Design According to Formula
			N	V _y	V _z	M _T	M _y	M _z	
1 Cross-section No. 1 - HEA 360									
	6.000	LC4	0.000	3.753	0.000	0.018	0.000	-0.018	101) Check of shear flow in top flange
	0.000	LC2	-23.438	0.000	-15.206	0.000	0.000	0.000	102) Check of shear flow in web
	6.000	LC4	0.000	3.753	0.000	0.018	0.000	-0.018	103) Check of shear flow in bottom flange
	3.000	LC4	0.000	0.003	0.000	0.018	0.000	5.616	104) Check of the allowable bending moment in top flange
	3.000	LC4	0.000	0.003	0.000	0.018	0.000	5.616	105) Check of the allowable bending moment in bottom flange
	0.000	LC1	-71.533	0.000	-11.085	0.001	0.000	0.000	106) Check of the minimum allowable axial force acting on cross-section
	0.000	LC1	-71.533	0.000	-11.085	0.001	0.000	0.000	107) Check of the maximum allowable axial force acting on cross-section
	6.000	LC2	-23.438	0.000	-15.206	0.000	-91.236	0.000	108) Check of the minimum allowable bending moment about the y-axis
	6.000	LC2	-23.438	0.000	-15.206	0.000	-91.236	0.000	109) Check of the maximum allowable bending moment about the y-axis
2 Cross-section No. 1 - HEA 360									
	6.000	LC4	0.000	3.753	0.000	-0.018	0.000	-0.018	101) Check of shear flow in top flange
	0.000	LC2	-23.438	0.000	15.206	0.000	0.000	0.000	102) Check of shear flow in web
	6.000	LC4	0.000	3.753	0.000	-0.018	0.000	-0.018	103) Check of shear flow in bottom flange
	3.000	LC4	0.000	0.003	0.000	-0.018	0.000	5.616	104) Check of the allowable bending moment in top flange
	3.000	LC4	0.000	0.003	0.000	-0.018	0.000	5.616	105) Check of the allowable bending moment in bottom flange
	0.000	LC1	-71.533	0.000	11.085	-0.001	0.000	0.000	106) Check of the minimum allowable axial force acting on cross-section
	0.000	LC1	-71.533	0.000	11.085	-0.001	0.000	0.000	107) Check of the maximum allowable axial force acting on cross-section
	6.000	LC2	-23.438	0.000	15.206	0.000	91.236	0.000	108) Check of the minimum allowable bending moment about the y-axis
	6.000	LC2	-23.438	0.000	15.206	0.000	91.236	0.000	109) Check of the maximum allowable bending moment about the y-axis
3 Cross-section No. 3 - IPE 450 ... 2 - IPE 360									
	3.011	LC4	0.000	-0.040	0.000	-0.017	0.000	0.100	101) Check of shear flow in top flange
	3.011	LC2	-16.693	0.000	16.428	0.000	-33.330	0.000	102) Check of shear flow in web
	3.011	LC4	0.000	-0.040	0.000	-0.017	0.000	0.100	103) Check of shear flow in bottom flange
	3.011	LC5	0.000	0.040	0.000	0.016	0.000	-0.102	104) Check of the allowable bending moment in top flange
	3.011	LC5	0.000	0.040	0.000	0.016	0.000	-0.102	105) Check of the allowable bending moment in bottom flange
	3.011	LC2	-16.693	0.000	16.428	0.000	-33.330	0.000	106) Check of the minimum allowable axial force acting on cross-section
	3.011	LC2	-16.693	0.000	16.428	0.000	-33.330	0.000	107) Check of the maximum allowable axial force acting on cross-section
	0.000	LC2	-17.180	0.000	22.031	0.000	-91.236	0.000	108) Check of the minimum allowable bending moment about the y-axis
	0.000	LC2	-17.180	0.000	22.031	0.000	-91.236	0.000	109) Check of the maximum allowable bending moment about the y-axis
4 Cross-section No. 2 - IPE 360									

Figure 4.7: Window 3.1 Governing Internal Forces by Member

This window shows for each member the governing internal forces that result in maximum design ratios in each check.

Location *x*

This column shows the respective *x*-location with the member's maximum design ratio.

Load Case

This column displays the number of the load case, load combination, or result combination whose internal forces produce the maximum design ratio.

Forces / moments

For each member, this column displays the axial and shear forces as well as the torsional and bending moments resulting in the maximum design ratios in the various cross-section checks.

Design According to Formula

The final column provides information on the check types and the formulas used in the checks according to [1], [2], or [3].

4.7 Governing Internal Forces by Set of Members

3.2 Governing Internal Forces by Set of Members

Set No.	A Location x [m]	B Load- ing	C			D Forces [kN]		E			F			G Moments [kNm]			H			I Design According to Formula
			N	V _y	V _z	M _T	M _y	M _z												
1	Continuous members 1 (Member No. 51,52)																			
	0.000	LC5	0.09	3.96	0.00	0.00	0.00	0.00	5.05	101	Check of shear flow in top flange									
	0.000	LC3	-0.02	0.01	2.70	0.00	-3.57	0.01	102	Check of shear flow in web										
	0.000	LC5	0.09	3.96	0.00	0.00	0.00	5.05	103	Check of shear flow in bottom flange										
	0.000	LC5	0.09	3.96	0.00	0.00	0.00	5.05	104	Check of the allowable bending moment in top flange										
	0.000	LC5	0.09	3.96	0.00	0.00	0.00	5.05	105	Check of the allowable bending moment in bottom flange										
	0.000	LC1	-89.68	-0.06	0.05	0.00	-0.05	-0.03	106	Check of the minimum allowable axial force acting on cross-section										
	0.000	LC1	-89.68	-0.06	0.05	0.00	-0.05	-0.03	107	Check of the maximum allowable axial force acting on cross-section										
	0.000	LC3	-0.02	0.00	1.90	0.00	-4.78	0.02	108	Check of the minimum allowable bending moment about the y-axis										
	0.000	LC3	-0.02	0.00	1.90	0.00	-4.78	0.02	109	Check of the maximum allowable bending moment about the y-axis										
2	Continuous members 2 (Member No. 13-15)																			
	0.000	LC1	-23.16	-0.02	15.54	-0.01	-31.01	0.01	101	Check of shear flow in top flange										
	3.011	LC1	-23.16	-0.02	15.55	-0.01	-31.01	0.01	102	Check of shear flow in web										
	0.000	LC1	-23.16	-0.02	15.54	-0.01	-31.01	0.01	103	Check of shear flow in bottom flange										
	3.262	LC4	-13.90	-0.10	-1.21	0.00	0.17	0.28	104	Check of the allowable bending moment in top flange										
	3.262	LC4	-13.90	-0.10	-1.21	0.00	0.17	0.28	105	Check of the allowable bending moment in bottom flange										
	0.000	LC1	-23.16	-0.02	15.54	-0.01	-31.01	0.01	106	Check of the minimum allowable axial force acting on cross-section										
	0.000	LC1	-23.16	-0.02	15.54	-0.01	-31.01	0.01	107	Check of the maximum allowable axial force acting on cross-section										
	5.791	LC1	-20.35	0.06	-0.09	0.00	44.88	-0.24	108	Check of the minimum allowable bending moment about the y-axis										
	5.791	LC1	-20.35	0.06	-0.09	0.00	44.88	-0.24	109	Check of the maximum allowable bending moment about the y-axis										
3	Continuous members 3 (Member No. 41-43)																			
	0.000	LC1	-42.78	0.01	15.29	0.02	-29.06	-0.02	101	Check of shear flow in top flange										
	3.011	LC1	-42.77	0.01	15.32	0.02	-29.06	-0.02	102	Check of shear flow in web										
	0.000	LC1	-42.78	0.01	15.29	0.02	-29.06	-0.02	103	Check of shear flow in bottom flange										
	6.274	LC4	-0.58	-0.13	0.10	0.00	0.74	0.62	104	Check of the allowable bending moment in top flange										
	6.274	LC4	-0.58	-0.13	0.10	0.00	0.74	0.62	105	Check of the allowable bending moment in bottom flange										
	0.000	LC1	-42.78	0.01	15.29	0.02	-29.06	-0.02	106	Check of the minimum allowable axial force acting on cross-section										
	0.000	LC1	-42.78	0.01	15.29	0.02	-29.06	-0.02	107	Check of the maximum allowable axial force acting on cross-section										
	0.000	LC1	-43.30	0.01	21.44	0.02	-84.24	0.01	108	Check of the minimum allowable bending moment about the y-axis										
	0.000	LC1	-43.30	0.01	21.44	0.02	-84.24	0.01	109	Check of the maximum allowable bending moment about the y-axis										
4	Continuous members 4 (Member No. 33,34)																			

Figure 4.8: Window 3.2 Governing Internal Forces by Set of Members

This window shows the internal forces that result in the maximum design ratios in the design of each set of members.

4.8 Parts List by Member

Finally, RF-STEEL Plastic provides a summary of all cross-sections used in the design case.

4.1 Parts List by Member

Part No.	A Cross-Section Description	B Number of Members	C Length [m]	D Total Length [m]	E Surface Area [m ²]	F Volume [m ³]	G Unit Weight [kg/m]	H Weight [kg]	I Total Weight [t]
1	1 - HEA 360	6	6.00	36.00	65.88	0.51	112.10	672.59	4.036
2	2 - IPE 360 ... 3 - IPE 450	8	3.01	24.09	35.65	0.21	67.33	202.76	1.622
3	2 - IPE 360	8	3.26	26.10	35.23	0.19	57.09	186.26	1.490
4	2 - IPE 360	8	6.27	50.19	67.76	0.37	57.09	358.20	2.866
5	1 - HEA 360	4	3.00	12.00	21.96	0.17	112.10	336.29	1.345
6	10 - HEA 140	3	3.00	9.00	7.11	0.03	24.66	73.99	0.222
7	10 - HEA 140	2	3.55	7.09	5.60	0.02	24.66	87.46	0.175
8	10 - HEA 140	1	4.09	4.09	3.23	0.01	24.66	100.98	0.101
9	15 - HEA 200	4	3.00	12.00	13.68	0.06	42.26	126.77	0.507
10	6 - HEA 160	3	3.00	9.00	8.19	0.03	30.43	91.30	0.274
11	6 - HEA 160	2	3.55	7.09	6.45	0.03	30.43	107.92	0.216
12	6 - HEA 160	1	4.09	4.09	3.73	0.02	30.43	124.60	0.125
13	7 - HEA 120	4	6.27	25.10	17.06	0.06	19.89	124.80	0.499
14	9 - IPE 200	8	6.25	50.00	38.50	0.14	22.36	139.73	1.118
15	6 - HEA 160	2	6.55	13.09	11.91	0.05	30.43	199.22	0.398
16	6 - HEA 160	1	7.09	7.09	6.46	0.03	30.43	215.90	0.216
17	12 - QRO 80x4 DIN 59410:1974	25	5.00	125.00	39.13	0.15	9.42	47.10	1.178
18	13 - Circle 24	4	7.81	31.24	2.36	0.01	3.55	27.74	0.111
19	13 - Circle 24	8	8.02	64.18	4.84	0.03	3.55	28.49	0.228
Sum		102		516.46	394.74	2.13			16.726

Figure 4.9: Window 4.1 Parts List by Member

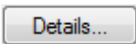

By default, this list contains only the designed members. If you need a parts list for all members of the model, select the corresponding option in the *Other* tab of the *Details* dialog box (see Figure 3.2, page 17).

Part No.

The program automatically assigns part numbers to similar members.

Cross-Section Description

This column shows the cross-section numbers and descriptions.

Number of Members

This column shows for each part how many similar members are used.

Length

This column displays the length of a single member.

Total Length

This column shows the product determined from the previous two columns.

Surface Area

For each part, the program indicates the surface area relative to the total length. The surface area is determined from the *Surface* of the cross-sections that can be seen in Windows 1.3 and 2.1 through 2.5 in the cross-section properties (see Figure 2.8, page 14).



Volume

The volume of a part is determined from the cross-sectional area and the total length.

Unit Weight

The *Unit Weight* is the weight of the section relative to the length of one meter. For tapered cross-sections, the program averages both cross-section properties.

Weight

The values of this column are determined from the respective product of the entries in column C and G.

Total Weight

The final column indicates the total weight of each part.

Sum

At the bottom of the list, you find a summary of the values in the columns B, D, E, F, and I. The last row of the *Total Weight* column informs you about the total amount of the required steel.

4.9 Parts List by Set of Members

4.2 Parts List by Set of Members

Part No.	A Set of Members Description	B Number of Sets	C Length [m]	D Total Length [m]	E Surface Area [m ²]	F Volume [m ³]	G Unit Weight [kg/m]	H Weight [kg]	I Total Weight [t]
1	Continuous members 1	1	12.55	12.55	17.33	0.10	59.55	747.23	0.747
2	Continuous members 2	1	12.55	12.55	17.33	0.10	59.55	747.23	0.747
3	Continuous members 3	1	12.55	12.55	8.53	0.03	19.89	249.60	0.250
4	Continuous members 4	1	12.55	12.55	8.53	0.03	19.89	249.60	0.250
Sum		4		50.19	51.73	0.25			1.994

Figure 4.10: Window 4.2 *Parts List by Set of Members*

The final results window is displayed if you have selected at least one set of members for design. It summarizes entire structural groups (for example, a horizontal beam) in a parts list.

The columns are described in the previous chapter. If different cross-sections are used in the set of members, the program averages the surface area, volume, and cross-section weight.

5. Evaluation of Results

You can evaluate the design results in different ways. The buttons below the upper table can help you evaluate the results.

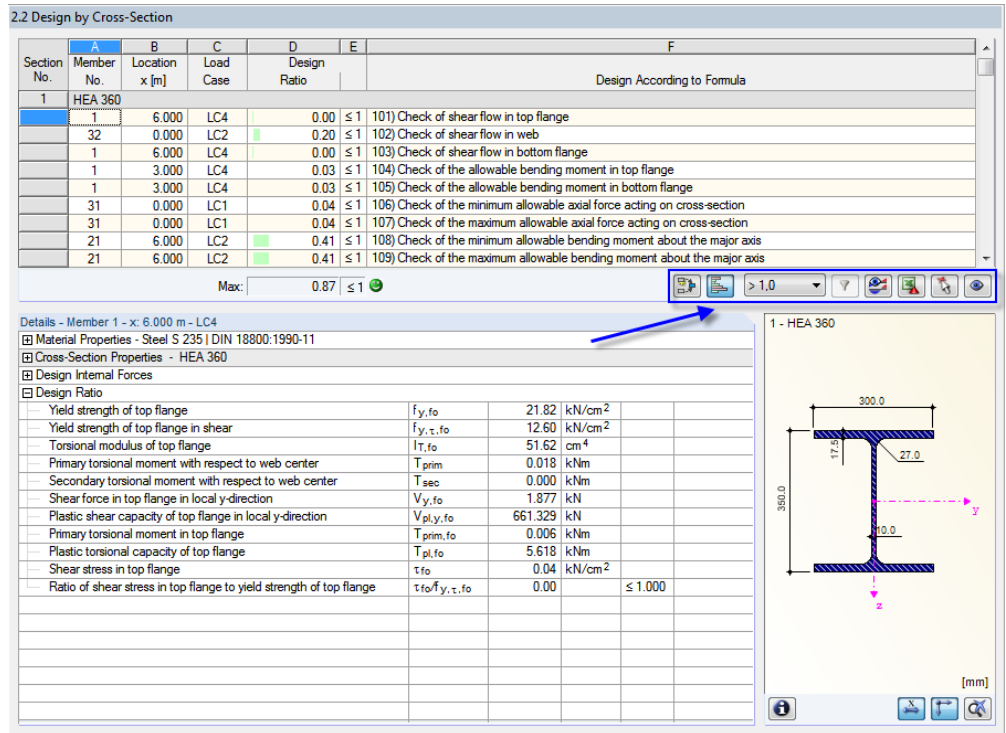

Figure 5.1: Button for evaluation of results

The buttons have the following functions:

Button	Description	Function
	Result combination	Creates a new result combination from the governing load cases and load combinations
	Color bar	Shows or hides the colored reference scales in the results windows
	Filter parameters	Represents the criterion for filtering the tables: Design ratios greater than 1, maximum value, or user-defined limit
	Apply filter	Shows only rows where the filter parameters are valid (ratio > 1, maximum, user-defined value)
	Result diagrams	Opens the dialog box <i>Result Diagram on Member</i> → Chapter 5.2, page 33
	Excel export	Exports the table to MS Excel / OpenOffice → Chapter 7.4.2, page 44
	Member selection	Allows for the graphical selection of a member to display its results in the table
	View mode	Goes to the RFEM work window for changing the view

Table 5.1: Buttons in the results windows 2.1 through 2.5

5.1 Results on the RFEM model

You can also evaluate the design results in the RFEM work window.

RFEM background graphic and view mode

The RFEM work window in the background is useful for finding the position of a member in the model. The member selected in the RF-STEEL Plastic results window is highlighted in the selection color in the background graphic. Furthermore, an arrow indicates the member's x-location displayed in the currently selected table row.

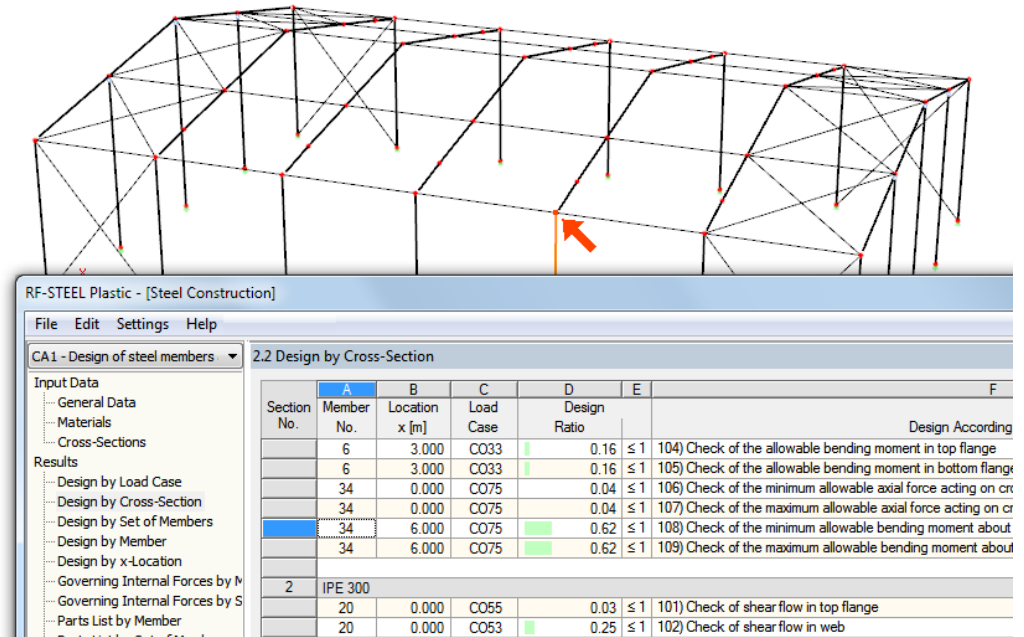

Figure 5.2: Indication of the member and the current Location x in the RFEM model

If you cannot improve the display by moving the RF-STEEL Plastic window, click [Jump to Graphic] to activate the *View Mode*. Thus, you hide the module window so that you can change the display in the RFEM graphical user interface. In the view mode, you can use the functions of the *View* menu, for example zooming, moving, or rotating the display. The indication arrow remains visible.

To return to the RF-STEEL Plastic module, click [Back].

RFEM work window

You can also graphically check the design ratios in the RFEM model. First, click [Graphics] to exit the design module. In the RFEM work window, the design ratios are now displayed like the internal forces of a load case.

To display or hide design results, use the [Show Results] button known from the display of internal forces. To display the result values, click the [Show Values] button in the toolbar to the right.

The RFEM tables are of no relevance for the evaluation of design results.

To set the design cases, you can use the list in the toolbar.



To adjust the results display, use the *Display* navigator below the entry *Results* → *Members*. The display of the design ratios is *Two-Colored* by default.

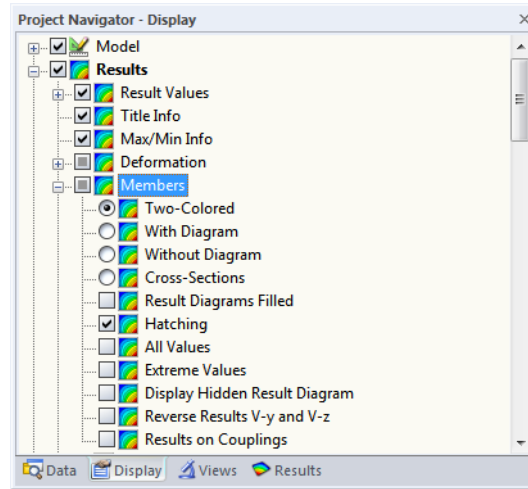

Figure 5.3: *Display* navigator: Results → Members



When you select a multicolor representation (options *With/Without Diagram* or *Cross-Sections*), the color scale panel becomes available. It provides the common control functions described in the RFEM manual, Chapter 3.4.6.

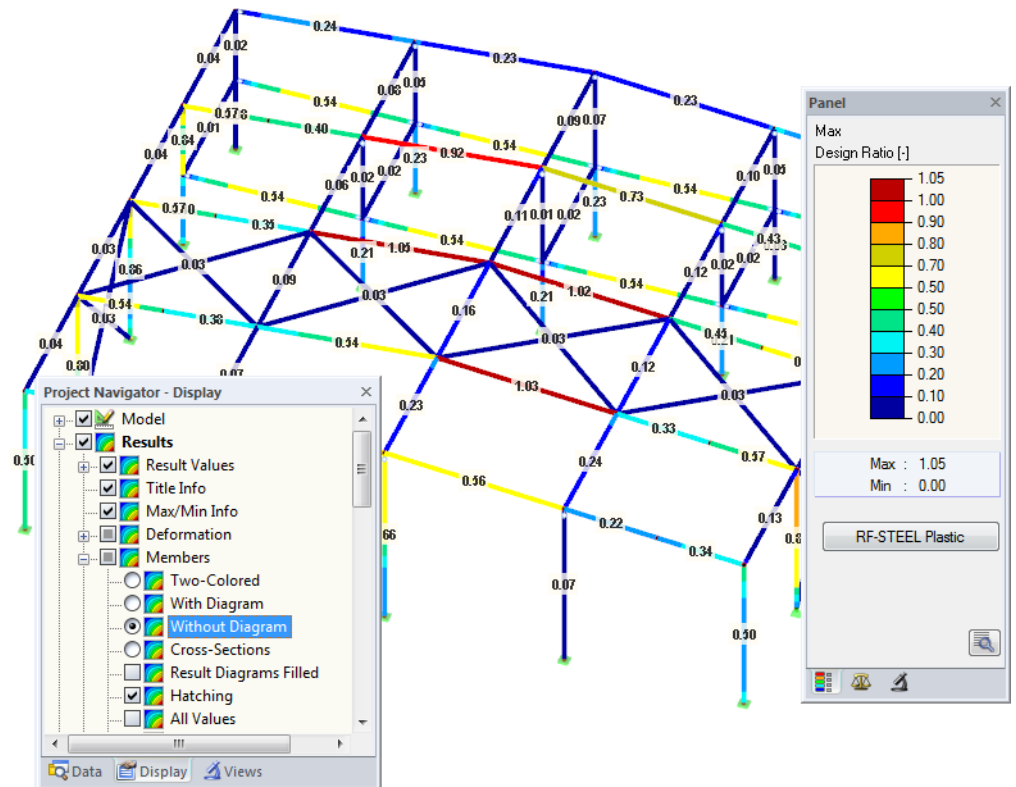

Figure 5.4: Design ratios with display option *Without Diagram*

You can transfer the graphics of the results to the printout report (see Chapter 6.2, page 36).

To return to the add-on module, click [RF-STEEL Plastic] in the panel.

RF-STEEL Plastic

5.2 Result Diagrams

You can also graphically evaluate a member's result distributions in a result diagram.



To do this, select the member (or set of members) in the RF-STEEL Plastic results window by clicking in the corresponding table row of the member. Then, open the *Result Diagram on Member* dialog box by clicking the button shown on the left. The button is located below the upper results table (see Figure 5.1, page 30).

To display the result diagrams, select the command from the RFEM menu



Results → Result Diagrams for Selected Members

or use the button in the RFEM toolbar shown on the left.

A window opens, graphically presenting the distribution of the maximum design values on the member or set of members.

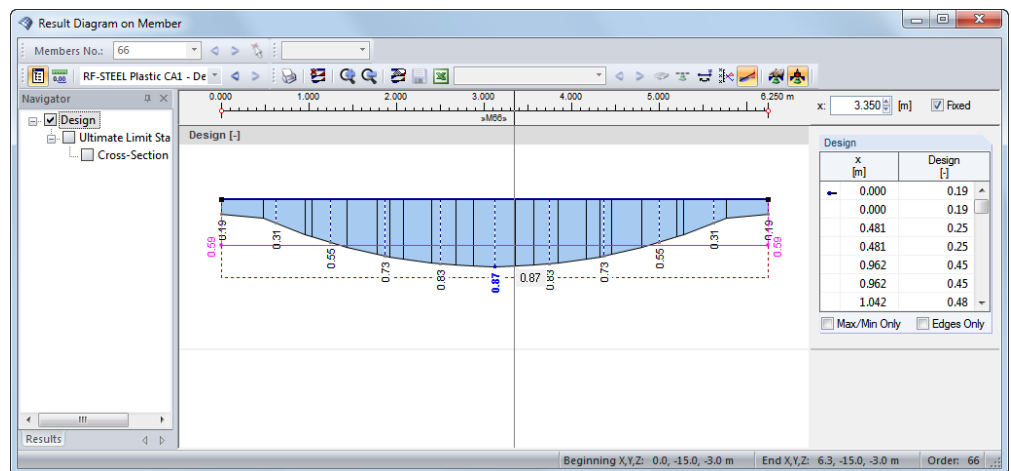
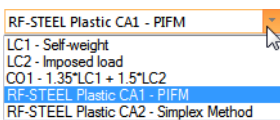

Figure 5.5: Dialog box *Result Diagram on Member*



To select the relevant RF-STEEL Plastic design case, use the list in the toolbar of the dialog box.

The *Result Diagram on Member* dialog box is described in the RFEM manual, Chapter 9.5.

5.3 Filter for Results

The results windows in RF-STEEL Plastic allow you to sort the results by various criteria. In addition, you can use the filter options to graphically evaluate the results as described in Chapter 9.7 of the RFEM manual.

In RF-STEEL Plastic, you can also use the *Visibilities* (see RFEM manual, Chapter 9.7.1) to filter the members for evaluation.

Filtering designs

The design ratios can easily be used as filter criteria in the RFEM work window which you can access by clicking [Graphics]. To apply this filter function, the panel must be displayed. If it is not, select in the RFEM menu

View → Control Panel (Color Scale, Factors, Filter)

or use the toolbar button shown on the left.

The panel is described in the RFEM manual, Chapter 3.4.6. You define the filter settings for the results in the first panel tab (Color spectrum). Because this register is not available for the two-colored results display, you have to use the *Display navigator* and set the display options *With/Without Diagram* or *Cross-Sections* first.

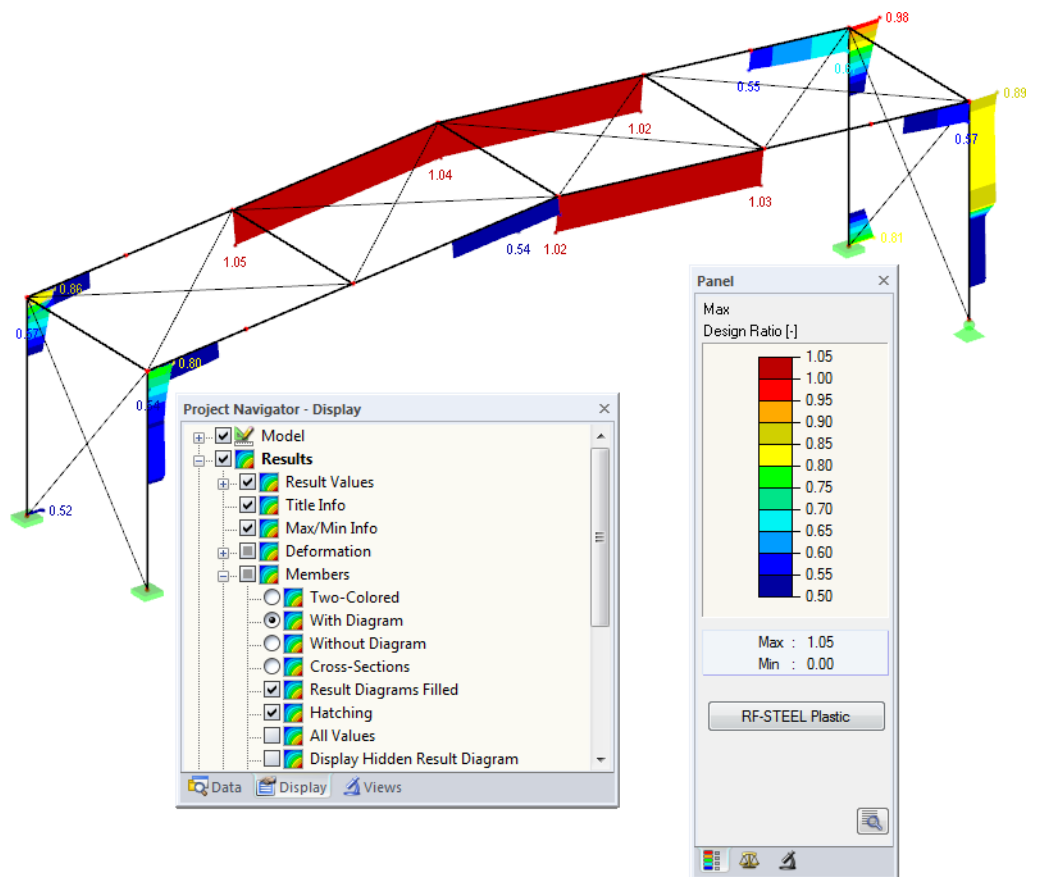

Figure 5.6: Filtering design ratios with adjusted color spectrum

As the figure above shows, the color spectrum can be set in such a way that only ratios higher than 0.50 are shown in a color range between blue and red.

If you select the *Display Hidden Result Diagram* option in the *Display navigator* (*Results*→*Members*), you can display all design ratio diagrams that are not covered by the color spectrum. Those diagrams will be represented by dotted lines.

Filtering members



In the *Filter* tab of the control panel, you can specify the numbers of particular members to display their results exclusively, that is, filtered. This function is described in the RFEM manual, Chapter 9.9.3.

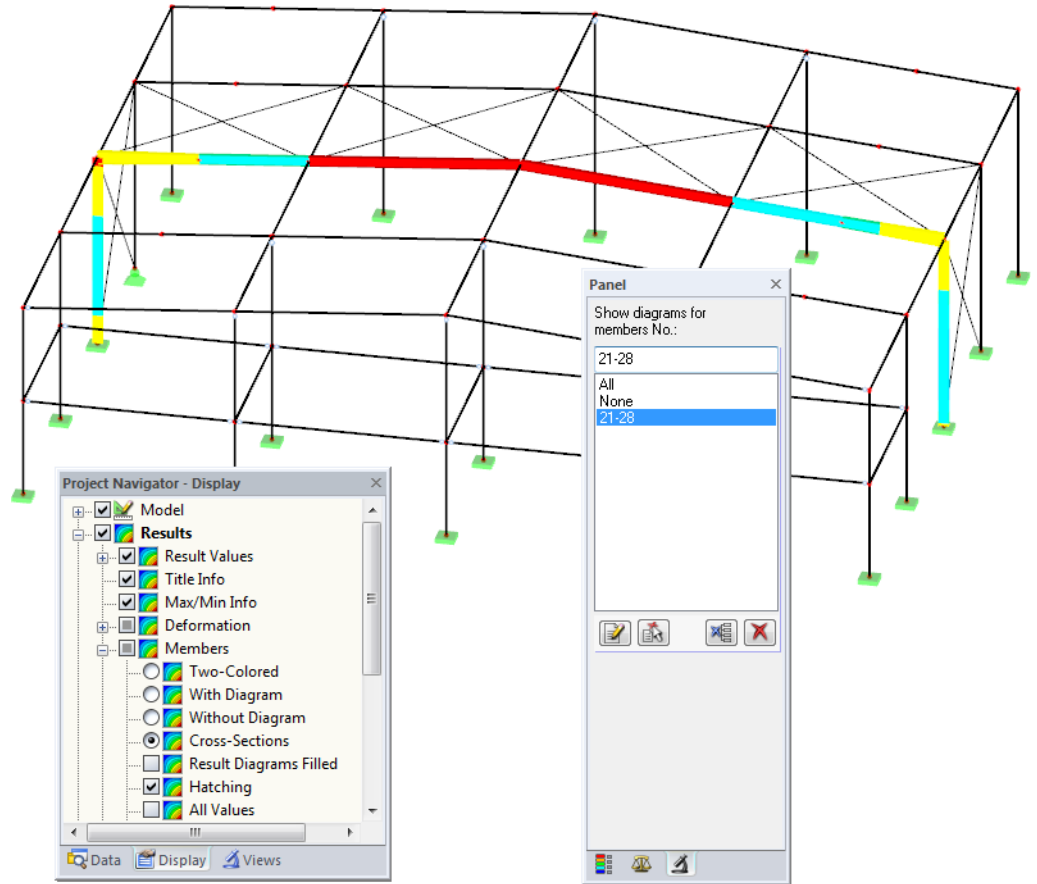

Figure 5.7: Member filter for the design ratios of a frame

Unlike the partial view function (*Visibilities*), the graphic displays the entire model. The figure above shows the design ratios of a frame. The remaining members are displayed in the model but are shown without design ratios.

6. Printout

6.1 Printout Report

Like in RFEM, the program generates a printout report for the RF-STEEL Plastic results, to which you can add graphics and descriptions. The selection in the printout report determines which data from the design module will be included in the final printout.



The printout report is described in the RFEM manual. In particular, Chapter 10.1.3.4 *Selecting Data of Add-on Modules* describes how to select input and output data from add-on modules for the printout report.

For large structural systems with many design cases, it is recommended to split the data into several printout reports, thus allowing for a clearly-arranged printout.

6.2 Graphic Printout

In RFEM, you can add every picture displayed in the work window to the printout report or send it directly to a printer. In this way, you can also prepare the design ratios displayed on the RFEM model for the printout.



Printing graphics is described in the RFEM manual, Chapter 10.2.

Designs on the RFEM Model

To print the current graphic of the design ratios, select the command in the menu



File → **Print**

or use the toolbar button shown on the left.

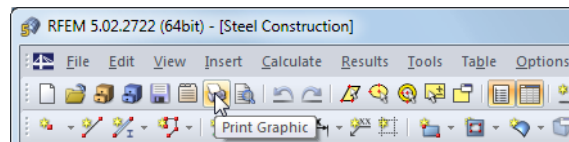

Figure 6.1: Button [Print Graphic] in RFEM toolbar

Result diagrams

In the *Result Diagram on Member* dialog box, you can also send the graphic with the design values to the report using the [Print] button. Furthermore, you can print the graphic directly.

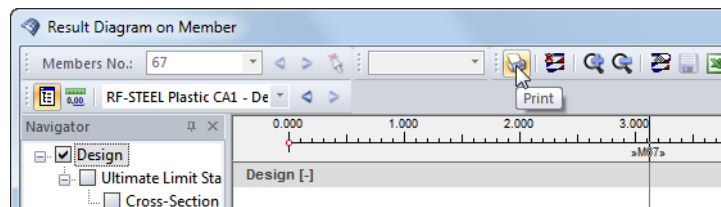

Figure 6.2: Button [Print] in the dialog box *Result Diagram on Member*

The following dialog box appears.

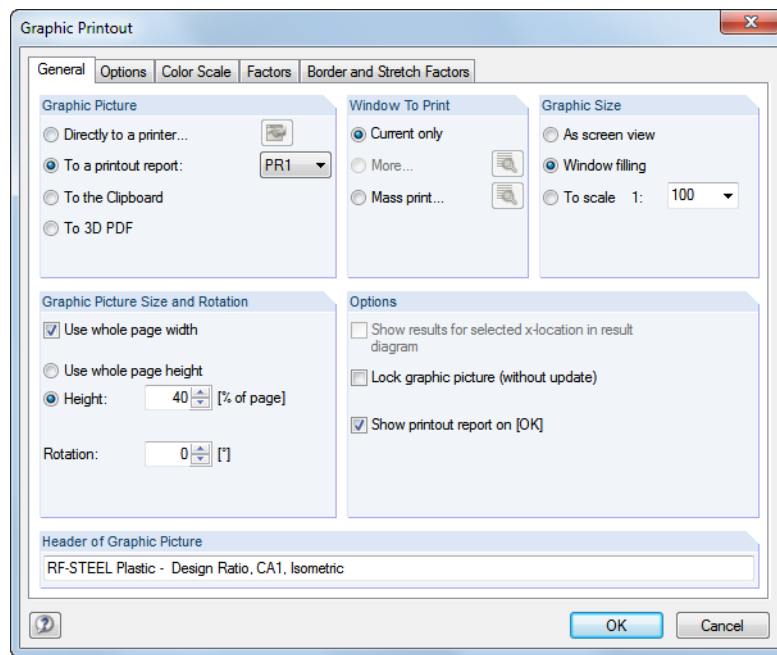

Figure 6.3: Dialog box *Graphic Printout*, tab *General*

This dialog box is described in the RFEM manual, Chapter 10.2. The manual also describes the *Options* and *Color Scale* tab.

To move a graphic within the printout report, use the drag-and-drop function.

To adjust a graphic in the printout report after the fact, right-click the corresponding entry in the navigator of the printout report. The *Properties* option in the context menu opens the *Graphic Printout* dialog box, offering various options for adjustment.

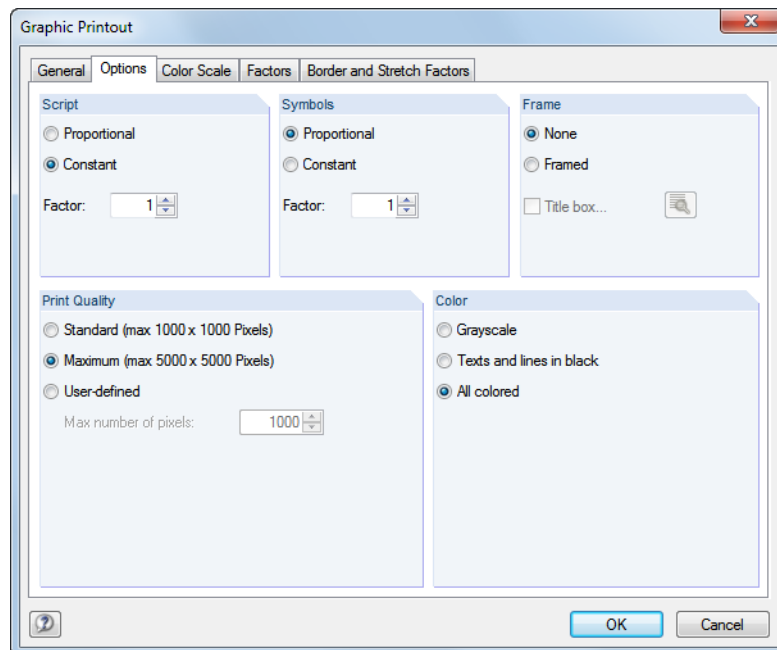
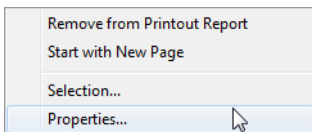

Figure 6.4: Dialog box *Graphic Printout*, tab *Options*

7. General Functions

This chapter describes useful menu functions and export options for the designs.

7.1 Design Cases

Design cases allow you to group members for the design. In this way, you can consider groups of structural components or analyze members with particular design specifications (for example, changed materials, partial safety factors, or optimization).

It is no problem to analyze the same member or set of members in different design cases.

To calculate a RF-STEEL Plastic design case, you can also use the load case list in the RFEM toolbar.

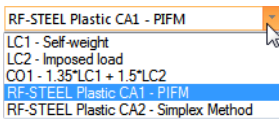

Creating new design case

To create a new design case, select in the RF-STEEL Plastic menu

File → New Case.

The following dialog box appears:

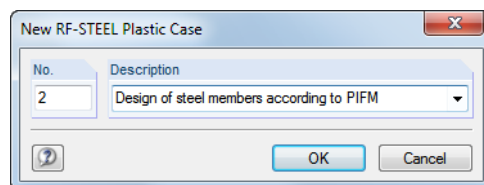

Figure 7.1: Dialog box *New RF-STEEL Plastic Case*

In this dialog box, enter a *No.* (one that is still available) for the new design case. An appropriate *Description* will make the selection in the load case list easier.

Click [OK] to open the 1.1 *General Data* window of RF-STEEL Plastic where you can enter the design data.

Renaming design case

To change the description of a design case, select in the RF-STEEL Plastic menu

File → Rename Case.

The following dialog box appears:

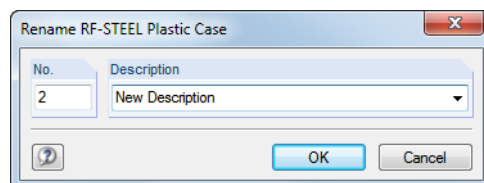

Figure 7.2: Dialog box *Rename RF-STEEL Plastic Case*

In this dialog box, you can specify a different *Description* as well as a different *No.* for the design case.

Copying design case

To copy the input data of the current design case, select from the RF-STEEL Plastic menu

File → Copy Case.

The following dialog box appears:

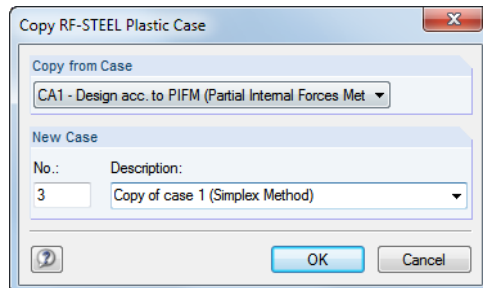

Figure 7.3: Dialog box *Copy RF-STEEL Plastic*

Define the *No.* and, if necessary, a *Description* for the new case.

Deleting design case

To delete design cases, select from the RF-STEEL Plastic menu

File → Delete Case.

The following dialog box appears:

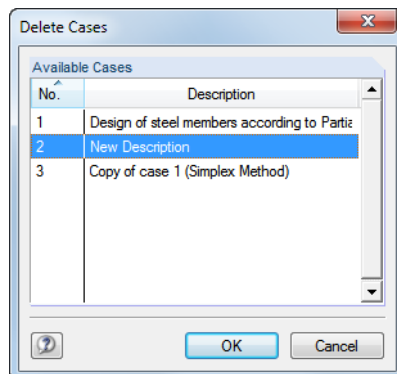
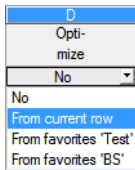

Figure 7.4: Dialog box *Delete Case*

First, select the design case from the *Available Cases*. To delete the selected case, click [OK].

7.2 Cross-Section Optimization



The design module offers you the option to optimize overstressed or little utilized cross-sections. To do this, select from the lists in column D or E of the 1.3 *Cross-Sections* window whether to determine the cross-section *From current row* or from the user-defined *Favorites* (see Figure 2.6, page 12). Alternatively, you can start the cross-section optimization in the results windows by using the context menu.

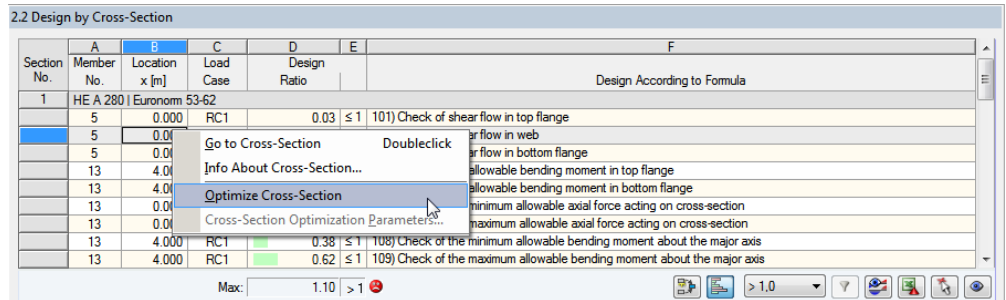

Figure 7.5: Context menu for cross-section optimization

During the optimization process, the module determines the cross-section that fulfills the design conditions in the most optimal way, that is, comes as close as possible to the maximum allowable design ratio specified in the *Details* dialog box (see Figure 3.2, page 17). The required cross-section properties are determined with the internal forces from RFEM. If another cross-section proves to be more favorable, this new cross-section is used for the design. Then, the graphic in Window 1.3 shows two cross-sections: the original cross-section from RFEM and the optimized one (see Figure 7.7).

For a parametric cross-section, the following dialog box appears when you select 'Yes' from the drop-down list.

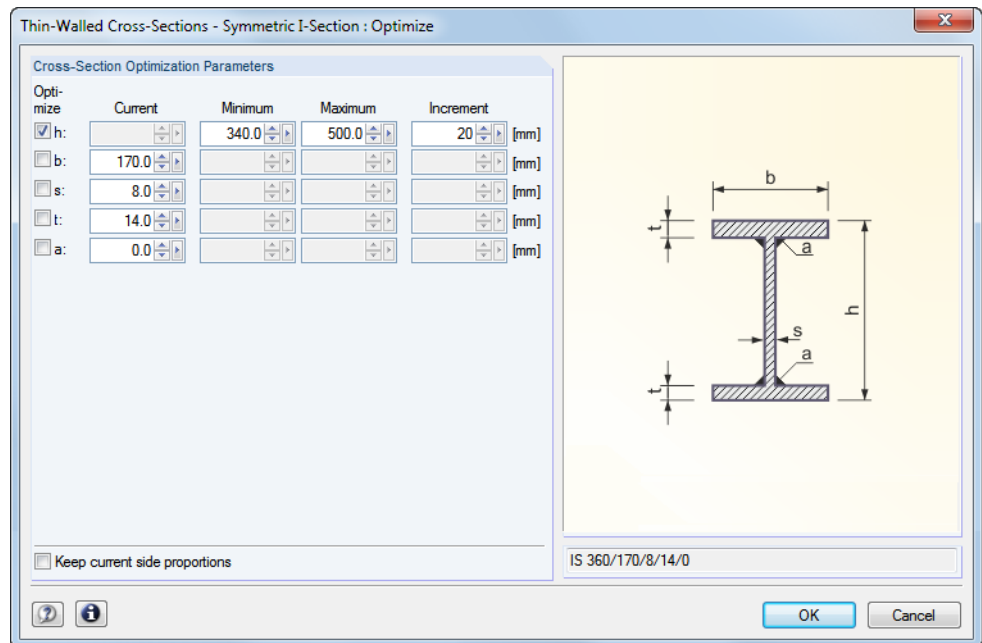

Figure 7.6: Dialog box *Welded Cross-Sections - Symmetric I-Section : Optimize*

By selecting the check boxes in the *Optimize* column, you decide which parameter(s) you want to modify. This enables the *Minimum* and *Maximum* columns, where you can specify the upper and lower limits of the parameter. The *Increment* column specifies the interval by which the size of the parameter varies during the optimization process.

If you want to *Keep current side proportions*, select the corresponding check box. In addition, you must select at least two parameters for optimization.

Cross-sections built up from rolled cross-sections cannot be optimized.



Please note that the internal forces will not be recalculated automatically with the changed cross-sections in the optimization. It is up to you to decide which cross-sections you want to transfer to RFEM for recalculation. Due to the changed stiffnesses in the structural system, the internal forces from the optimized cross-section may vary significantly. Therefore, it is recommended to recalculate the internal forces of the modified cross-section data after the first optimization, and then to optimize the cross-sections once again.

You can export the modified cross-sections to RFEM. To do this, go to the 1.3 *Cross-Sections* window, and then select the command from the menu

Edit → Export All Cross-Sections to RFEM.

Alternatively, you can use the context menu in Window 1.3 to export optimized cross-sections to RFEM.

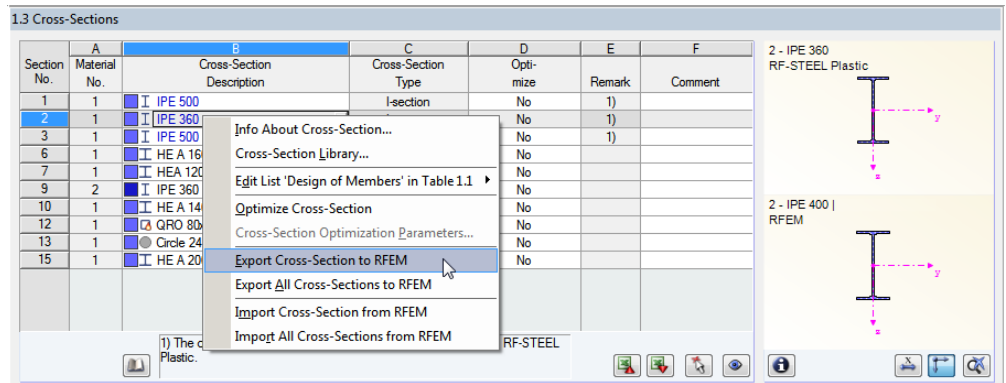

Figure 7.7: Context menu in Window 1.3 *Cross-Sections*

Before the modified materials are transferred to RFEM, a query appears as to whether you want to delete the results in RFEM and RF-STEEL Plastic.

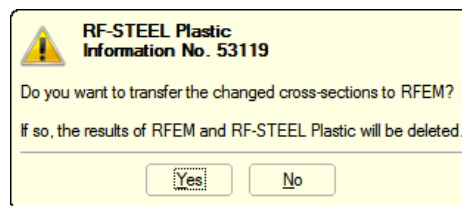

Figure 7.8: Query before export of modified cross-sections to RFEM

Calculation

By confirming the query, and then starting the [Calculation] in the RF-STEEL Plastic module, the RFEM internal forces as well as the checks will be determined in a single calculation run.

If the modified cross-sections are not exported to RFEM, you can reimport the original cross-sections in the design module by using the options shown in Figure 7.7. Please note that this option is available in the 1.3 *Cross-Sections* window only.



If you optimize a tapered member, the program modifies the start and end sections of the member. Then, the program linearly interpolates the second moments of area at the intermediate locations. Because these moments are considered with the fourth power, the analyses may be inaccurate if the depths of the start and the end cross-section differ significantly. In such a case, it is recommended to divide the taper into several members, thus modeling the taper layout manually.

7.3 Units and Decimal Places

Units and decimal places for RFEM and the add-on modules are managed in one common dialog box. To specify the units for RF-STEEL Plastic, select in the module menu

Settings → Units and Decimal Places.

The dialog box known from RFEM appears. In the *Program / Module* dialog box section, RF-STEEL Plastic is preset.

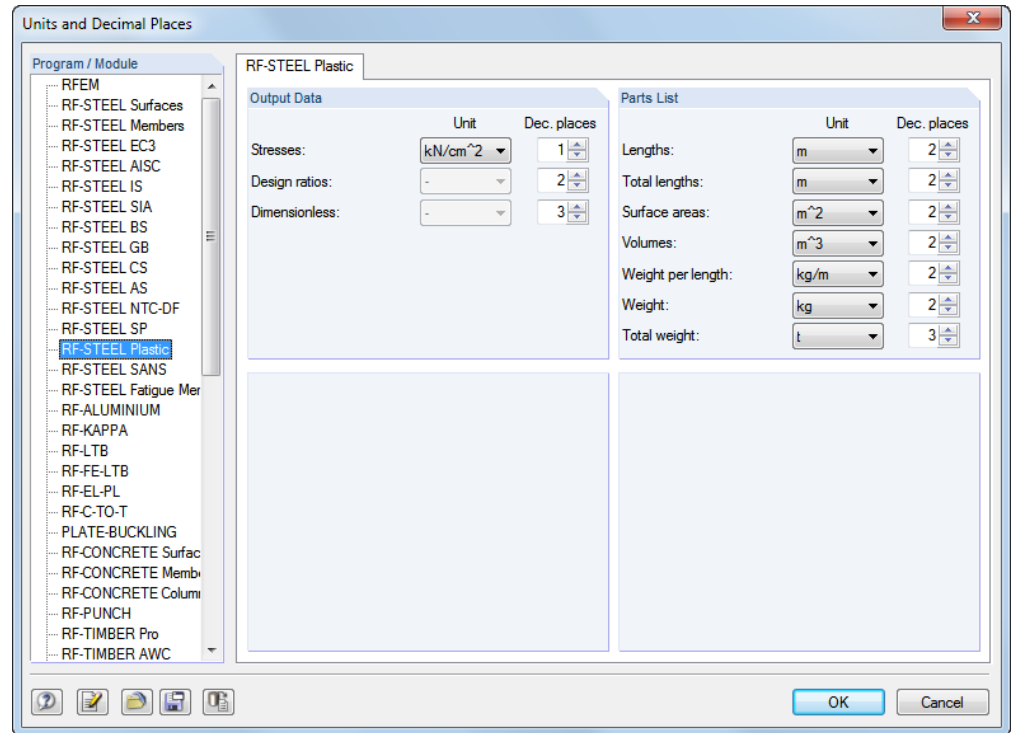

Figure 7.9: Dialog box *Units and Decimal Places*



To reuse the settings in other models, save them as a user-profile. These functions are described in the RFEM manual, Chapter 11.1.3.

7.4 Data Exchange

7.4.1 Exporting Materials to RFEM

If you adjusted the materials in RF-STEEL Plastic for design, you can export the modified materials to RFEM in a similar way as you export cross-sections. To do this, go to the 1.2 *Materials* window, and then select the command in the menu

Edit → **Export All Materials to RFEM**.

Alternatively, you can export the modified materials to RFEM by using the context menu in Window 1.2.

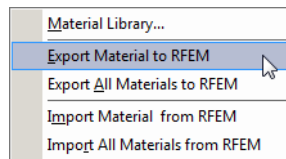

Figure 7.10: Context menu of Window 1.2 *Materials*

Calculation

Before the modified materials are transferred to RFEM, a query appears as to whether you want to delete the results in RFEM. After you confirm the query and start the [Calculation] in RF-STEEL Plastic, the RFEM internal forces and designs are determined in a single calculation run.

If the modified materials are not exported to RFEM, you can transfer the original materials to the design module, using the options shown in Figure 7.10. Please note, however, that this option is only available in the 1.2 *Materials* window.

7.4.2 Exporting Results

You can use the RF-STEEL Plastic results also in other programs.

Clipboard

To copy cells selected in the results windows to the Clipboard, press the keys [Ctrl]+[C]. To insert the cells, for example in a word processor, press [Ctrl]+[V]. The headers of the table columns are not transferred.

Printout report

You can print the data of the RF-STEEL Plastic module into the printout report (see Chapter 6.1, page 36) for export. Then, in the printout report, you can export them by selecting in the report menu

File → **Export in RTF**.

This function is described in the RFEM manual, Chapter 10.1.11.

Excel / OpenOffice

RF-STEEL Plastic provides a function for the direct data export to MS Excel, OpenOffice.org Calc, or the file format CSV. To open the corresponding dialog box, select on the module menu

File → **Export Tables**.

The following dialog box appears.

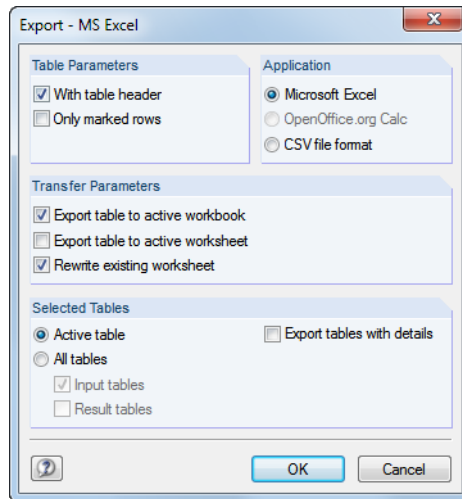

Figure 7.11: Dialog box *Export - MS Excel*

Having selected the relevant options, you can start the export by clicking [OK]. Excel or OpenOffice are started automatically, that is, you do not need to open the programs beforehand.

Section No.	Member No.	Location x [m]	Load Case	Design Ratio	Description
IPE 500					
1	1	6,000	LC4	0,01 ≤ 1	101) Check of shear flow in top flange
2	32	0,000	LC2	0,13 ≤ 1	102) Check of shear flow in web
3	1	6,000	LC4	0,01 ≤ 1	103) Check of shear flow in bottom flange
4	1	3,000	LC4	0,08 ≤ 1	104) Check of the allowable bending moment in top flange
5	1	3,000	LC4	0,08 ≤ 1	105) Check of the allowable bending moment in bottom flange
6	31	0,000	LC1	0,05 ≤ 1	106) Check of the minimum allowable axial force acting on cross-section
7	31	0,000	LC1	0,05 ≤ 1	107) Check of the maximum allowable axial force acting on cross-section
8	21	6,000	LC2	0,39 ≤ 1	108) Check of the minimum allowable bending moment about the major axis
9	21	6,000	LC2	0,39 ≤ 1	109) Check of the maximum allowable bending moment about the major axis
IPE 330					
10	4	0,000	LC4	0,00 ≤ 1	101) Check of shear flow in top flange
11	23	0,000	LC2	0,13 ≤ 1	102) Check of shear flow in web
12	4	0,000	LC4	0,00 ≤ 1	103) Check of shear flow in bottom flange
13	42	3,262	LC4	0,01 ≤ 1	104) Check of the allowable bending moment in top flange
14	42	3,262	LC4	0,01 ≤ 1	105) Check of the allowable bending moment in bottom flange
15	42	0,000	LC2	0,06 ≤ 1	106) Check of the minimum allowable axial force acting on cross-section
16	42	0,000	LC2	0,06 ≤ 1	107) Check of the maximum allowable axial force acting on cross-section
17	23	0,000	LC2	0,85 ≤ 1	108) Check of the minimum allowable bending moment about the major axis
18	23	0,000	LC2	0,85 ≤ 1	109) Check of the maximum allowable bending moment about the major axis

Figure 7.12: Results in *Excel*

8. Worked Examples

8.1 Doubly Symmetrical I-Section

The following example is presented in [1], page 431. The interaction from axial force and double-bending without warping is analyzed according to PIFM.

Cross-Section

Doubly symmetrical I-section HE B 200

Steel S 235

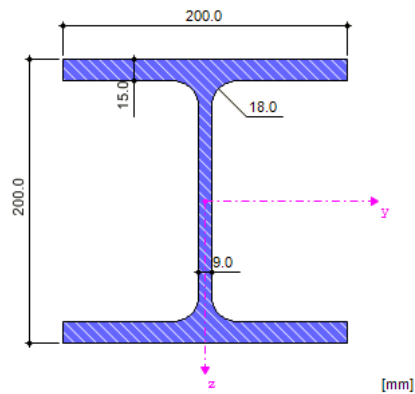

Figure 8.1: Doubly symmetrical I-section HE B 200

Cross-section properties

Cross-section property	Symbol	Value	Unit
Depth	h	200.00	mm
Width	b	200.00	mm
Web thickness	t_w	9.00	mm
Flange thickness	t_f	15.00	mm
Root fillet radius	r	18.00	mm
Depth between flanges	$d - 2t_f$	170.00	mm
Depth of straight web	d	134.00	mm
Cross-sectional area	A	78.08	cm ²
Shear area	A_y	50.03	cm ²
Shear area	A_z	15.32	cm ²
Effective shear area according to EC 3	$A_{v,y}$	62.43	cm ²
Shear area according to EC 3	$A_{v,z}$	24.83	cm ²
Plastic shear area	$A_{pl,y}$	60.00	cm ²
Plastic shear area	$A_{pl,z}$	16.65	cm ²
Moment of inertia	I_y	5696.00	cm ⁴
Moment of inertia	I_z	2003.00	cm ⁴
Governing radius of gyration	r_y	85.40	mm
Governing radius of gyration	r_z	50.70	mm
Polar radius of gyration	r_o	99.30	mm
Radius of gyration of flange section plus $1/5$ of web area	r_{zg}	53.90	mm

Volume	V	7808.00	cm ³ /m
Weight	wt	61.30	kg/m
Surface	A _{surf}	1.15	m ² /m
Section factor	A _m /V	147.285	1/m
Torsional constant	J	59.28	cm ⁴
Warping constant	C _w	171,100.00	cm ⁶
Elastic section modulus	S _y	569.60	cm ³
Elastic section modulus	S _z	200.30	cm ³
Warping section modulus	W _w	1849.73	cm ⁴
Statical moment of area	Q _{y,max}	321.25	cm ³
Statical moment of area	Q _{z,max}	75.00	cm ³
Normalized warping constant	W _{no}	92.50	cm ²
Warping statical moment	Q _w	693.75	cm ⁴
Plastic section modulus	Z _y	642.50	cm ³
Plastic section modulus	Z _z	305.80	cm ³
Plastic warping section modulus	Z _w	2775.00	cm ⁴
Plastic shape factor	Z _y /S _y	1.128	
Plastic shape factor	Z _z /S _z	1.527	
Plastic shape factor	Z _w /W _w	1.500	

Table 8.1: Cross-section properties HE B 200

Loading

Axial force $N_{Ed} = 1000.00$ kN

Moment $M_{z,Ed} = 26.20$ kNm

Moment $M_{y,Ed} = 34.50$ kNm

8.1.1 Check of Allowable Bending Moment in Top Flange

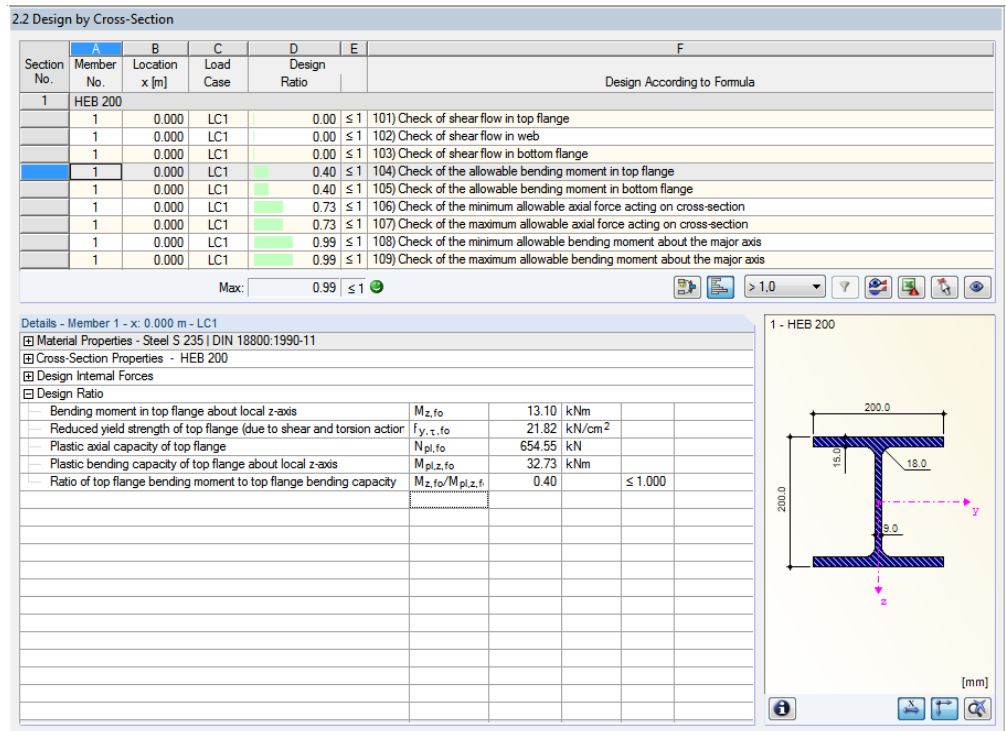

Figure 8.2: Check of the allowable bending moment at top flange

Material properties

$$f_{y,d} = \frac{f_{y,k}}{\gamma_M} = \frac{24.00}{1.1} = \underline{\underline{21.82 \text{ kN/cm}^2}}$$

$$\tau_{Rd} = \frac{f_{y,d}}{\sqrt{3}} = \frac{21.82}{\sqrt{3}} = \underline{\underline{12.60 \text{ kN/cm}^2}}$$

Partial internal forces in cross-section parts according to [1], Table 10.9

$$M_t = M_b = \frac{M_z}{2} - \frac{M_\omega}{a_f}$$

$$M_t = M_b = \frac{26.20}{2} - \frac{0}{(20.0 - 1.50)}$$

$$M_t = M_b = \underline{\underline{13.10 \text{ kNm}}}$$

Limiting plastic internal forces according to [1], Table 10.9

$$M_{pl,i,\tau} = \frac{t_f \cdot b^2}{4} \cdot f_{y,d} \cdot \sqrt{1 - \left(\frac{\tau_i}{\tau_{Rd}}\right)^2}$$

$$M_{pl,i,\tau} = \frac{1.50 \cdot 20.0^2}{4} \cdot 21.32 \cdot \sqrt{1 - (0)^2}$$

$$M_{pl,i,\tau} = \underline{\underline{3272.72 \text{ kNcm} = 32.73 \text{ kNm}}}$$

where $i = o, u$

Check according to [1], Table 10.9

$$\frac{M_i}{M_{pl,i,\tau}} \leq 1.00$$

$$\frac{13.10}{32.73} = 0.40 \leq 1.00$$

8.1.2 Check of the Allowable Axial Force

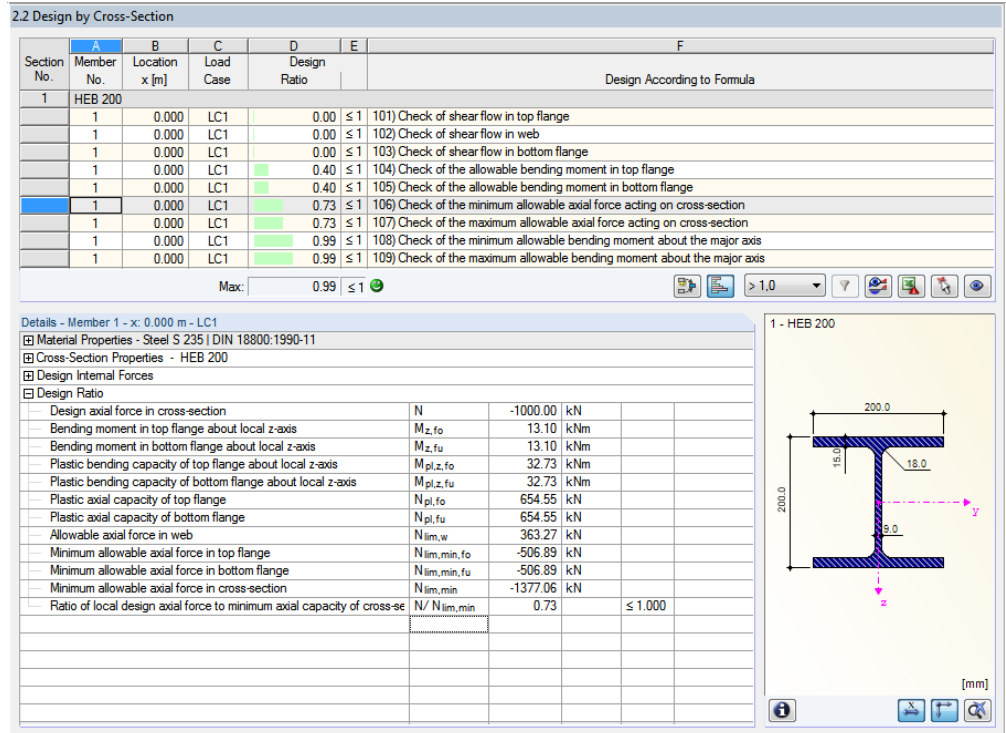

Figure 8.3: Check of the allowable axial forces

Limiting plastic internal forces according to [1], Table 10.8

$$N_{lim,i} = t_f \cdot b \cdot f_{y,d} \cdot \sqrt{1 - \left(\frac{\tau_i}{\tau_{Rd}}\right)} \cdot \sqrt{1 - \left(\frac{M_i}{M_{pl,i,\tau}}\right)}$$

$$N_{lim,i} = 1.50 \cdot 20.0 \cdot 21.32 \cdot \sqrt{1 - 0} \cdot \sqrt{1 - 0.40}$$

$$N_{lim,i} = \underline{506.89 \text{ kN}}$$

where $i = o, u$

$$N_{lim,w} = t_w \cdot h_w \cdot f_{y,d} \cdot \sqrt{1 - \left(\frac{\tau_s}{\tau_{Rd}}\right)^2}$$

$$N_{lim,w} = 0.9 \cdot (20.0 - 1.50) \cdot 21.32 \cdot \sqrt{1 - 0^2}$$

$$N_{lim,w} = \underline{363.27 \text{ kN}}$$

$$N_{lim} = N_{lim,t} + N_{lim,b} + N_{lim,w}$$

$$N_{lim} = 506.89 + 506.89 + 363.27$$

$$N_{lim} = \underline{1377.06 \text{ kN}}$$

Check

$$\frac{N}{N_{lim}} \leq 1.00$$

$$\frac{1000}{1377.06} = 0.73 \leq 1.00$$

8.1.3 Check of the Allowable Bending Moment

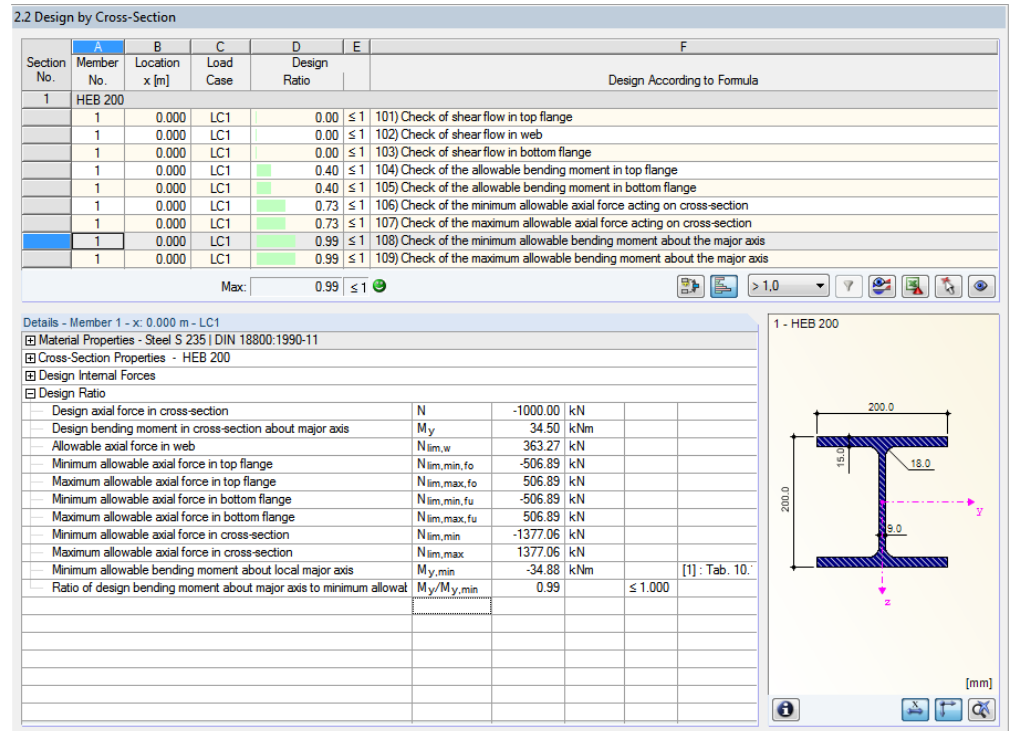

Figure 8.4: Design of the allowable bending moment about major axis

Governing case according to [1], Table 10.8

Case 3:

$$N_{lim} - 2 \cdot N_{lim,b} \leq N \leq N_{lim}$$

$$1377.06 - 2 \cdot 506.89 \leq 1000.00 \leq 1377.06$$

$$363.28 \leq 1000.00 \leq 1377.06 \Rightarrow \text{OK}$$

Limiting plastic internal forces [1], Table 10.8

$$\max M_y = (2 \cdot N_{lim,b} + N_{lim,w} - N) \cdot \frac{a_f}{2}$$

$$\max M_y = (2 \cdot 506.89 + 363.27 - 1000.00) \cdot \frac{0.20 - 0.015}{2}$$

$$\max M_y = 34.877 \text{ kNm}$$

Check according to [1], Table 10.8

$$\frac{M_y}{\max M_y} \leq 1.00$$

$$\frac{34.50}{34.88} = 0.99 \leq 1.00$$

8.2 Monosymmetrical I-Section

The following example is presented in [1], page 190 f. The interaction from double-bending with shear force but without taking account of bimoment M_ω is analyzed.

Cross-Section

Monosymmetrical I-Section IU 432/300/20/12/180/12

Steel S 235

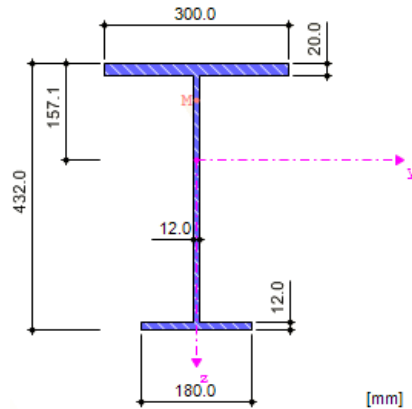

Figure 8.5: Monosymmetrical I-Section IU 432/300/20/12/180/12

Cross-section properties

Cross-section property	Symbol	Value	Unit
Depth	h	432.000	mm
Upper flange width	b_t	300.000	mm
Upper flange thickness	t_t	20.000	mm
Web thickness	s	12.000	mm
Lower flange width	b_b	180.000	mm
Lower flange thickness	t_b	12.000	mm
Upper fillet web thickness	a_t	6.000	mm
Lower fillet web thickness	a_b	6.000	mm
Cross-sectional area	A	129.600	cm ²
Shear area	A_y	81.600	cm ²
Shear area	A_z	48.000	cm ²
Distance to center of gravity	e_z	157.100	mm
Moment of inertia	I_y	36,923.100	cm ⁴
Moment of inertia	I_z	5088.960	cm ⁴
Polar moment of inertia	I_p	42,012.000	cm ⁴
Polar moment of inertia	$I_{p,M}$	54,783.600	cm ⁴
Moment of inertia referred to the smaller flange	$I_{y,SF}$	37,271.600	cm ⁴
Governing radius of gyration	r_y	168.800	mm
Governing radius of gyration	r_z	62.700	mm
Polar radius of gyration	r_o	180.000	mm
Polar radius of gyration	$r_{p,M}$	205.700	mm
Weight	wt	101.700	kg/m

Surface	A_{surf}	1.800	m^2/m
Torsional constant	J	110.530	cm^4
Distance from the shear center to the center of gravity S	z_M	-99.300	mm
Warping constant referring to M	C_w	893,470.000	cm^6
Flare factor	λ	0.001	1/mm
Elastic section modulus	$S_{y,\text{max}}$	1343.200	cm^3
Elastic section modulus	$S_{y,\text{min}}$	-2350.120	cm^3
Elastic section modulus	S_z	339.260	cm^3
Warping section modulus	W_w	2696.510	cm^4
Statical moment of area	$Q_{y,\text{max}}$	995.460	cm^3
Statical moment of area	$Q_{z,\text{max}}$	224.910	cm^3
Normalized warping constant	W_{no}	331.340	cm^2
Warping statical moment	Q_w	1789.250	cm^4
Stability parameter according to Kindem	$r_{y,\text{Kindem}}$	87.000	mm
Stability parameter	$r_{M,z}$	285.500	mm
Location of area center line	f_z	-97.100	mm
Plastic section modulus	Z_y	1877.760	cm^3

Table 8.2: Cross-section properties IU 432/300/20/12/180/12

Material properties

$$f_{y,d} = \frac{f_{y,k}}{\gamma_M} = \frac{24.00}{1.1} = \underline{\underline{21.82 \text{ kN/cm}^2}}$$

$$\tau_{Rd} = \frac{f_{y,d}}{\sqrt{3}} = \frac{21.82}{\sqrt{3}} = \underline{\underline{12.60 \text{ kN/cm}^2}}$$

Loading

Shear force $V_{z,Ed} = 121.67 \text{ kN}$

Shear force $V_{y,Ed} = 28.28 \text{ kN}$

Moment $M_{z,Ed} = -62.45 \text{ kNm}$

Moment $M_{y,Ed} = 271.59 \text{ kNm}$

8.2.1 Transformation of Internal Forces

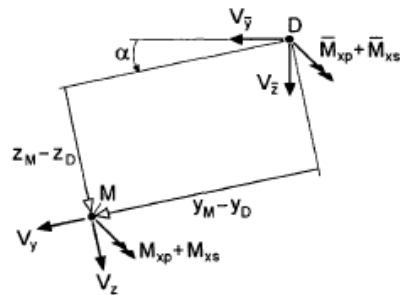

τ internal forces

$$\bar{M}_{x_p} = M_{x_p}$$

$$V_{\bar{y}} = V_y \cdot \cos \alpha - V_z \cdot \sin \alpha$$

$$V_{\bar{z}} = V_z \cdot \cos \alpha + V_y \cdot \sin \alpha$$

$$\bar{M}_{x_s} = M_{x_s} - V_y \cdot (z_M - z_D) + V_z \cdot (y_M - y_D)$$

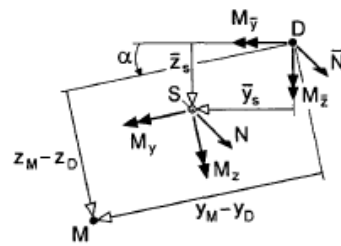

σ internal forces

$$\bar{N} = N$$

$$M_{\bar{y}} = M_y \cdot \cos \alpha - M_z \cdot \sin \alpha + N \cdot \bar{z}_s$$

$$M_{\bar{z}} = M_z \cdot \cos \alpha + M_y \cdot \sin \alpha - N \cdot \bar{y}_s$$

$$M_{\bar{\omega}} = M_{\omega} + M_y \cdot (y_M - y_D) + M_z \cdot (z_M - z_D) + N \cdot \bar{\omega}_k$$

in addition : M_{ω} in M and $M_{\bar{\omega}}$ in D

Figure 8.6: Transformation of internal forces in reference coordinate system according to [1], Table 10.16

$$V_{\bar{y}} = V_y \cdot \cos \alpha - V_z \cdot \sin \alpha$$

$$V_{\bar{y}} = 28.28 \cdot \cos 0^\circ - 121.67 \cdot \sin 0^\circ$$

$$V_{\bar{y}} = \underline{\underline{28.28 \text{ kN}}}$$

$$V_{\bar{z}} = V_z \cdot \cos \alpha - V_y \cdot \sin \alpha$$

$$V_{\bar{z}} = 121.67 \cdot \cos 0^\circ - 28.28 \cdot \sin 0^\circ$$

$$V_{\bar{z}} = \underline{\underline{121.67 \text{ kN}}}$$

$$\bar{M}_{x_s} = M_{x_s} - V_y \cdot (z_M - z_D) + V_z \cdot (y_M - y_D)$$

$$\bar{M}_{x_s} = 0.00 - 28.28 \cdot (-16.23 - 0) + 121.67 \cdot (0 - 0)$$

$$\bar{M}_{x_s} = \underline{\underline{458.90 \text{ kNcm} = 4.589 \text{ kNm}}}$$

$$M_{\bar{y}} = M_y \cdot \cos \alpha - M_z \cdot \sin \alpha + N \cdot \bar{z}_s$$

$$M_{\bar{y}} = 271.59 \cdot \cos 0^\circ - (-62.45) \cdot \sin 0^\circ + 0$$

$$M_{\bar{y}} = \underline{\underline{271.59 \text{ kNm}}}$$

$$M_{\bar{z}} = M_z \cdot \cos \alpha - M_y \cdot \sin \alpha + N \cdot \bar{y}_s$$

$$M_{\bar{z}} = -62.45 \cdot \cos 0^\circ - 271.59 \cdot \sin 0^\circ + 0$$

$$M_{\bar{z}} = \underline{\underline{-62.45 \text{ kNm}}}$$

$$M_{\bar{\omega}} = M_{\omega} + M_y \cdot (y_M - y_D) + M_z \cdot (z_M - z_D) + N \cdot \bar{\omega}_k$$

$$M_{\bar{\omega}} = 0.00 + 27.159 \cdot (0.0 - 0.0) + (-62.45) \cdot (-16.23 - 0.0) + 0$$

$$M_{\bar{\omega}} = \underline{\underline{101.339 \text{ kNcm}^2}}$$

8.2.2 Shear Resistance in Top Flange

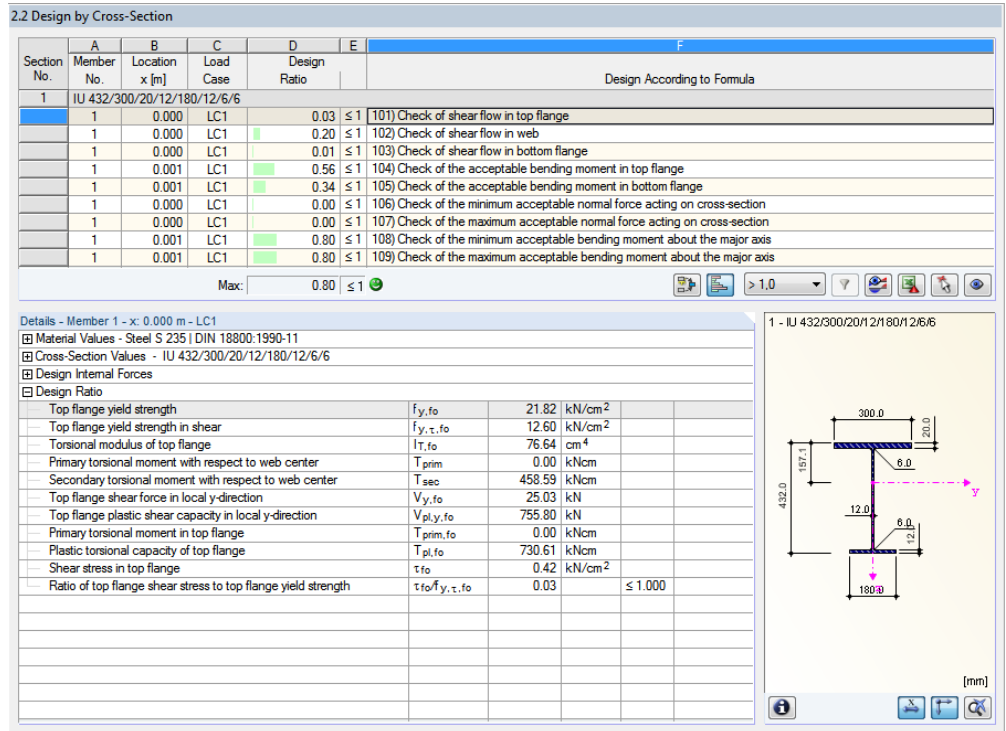

Figure 8.7: Check of shear resistance in top flange

Partial internal forces in cross-section parts according to [1], Table 10.17

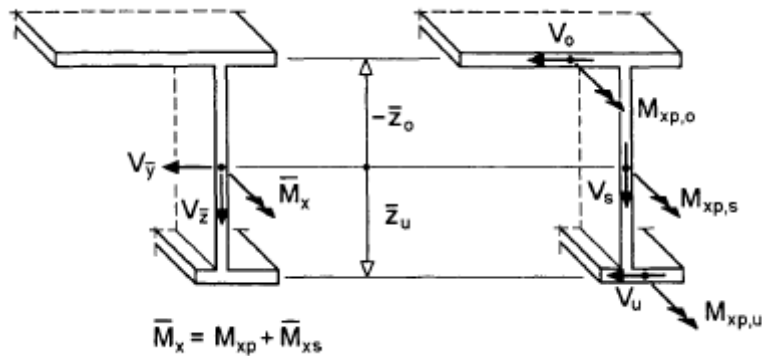

Figure 8.8: Internal forces τ in cross-section consisting of three plates acc. to Figure 10.40 [1]

$$V_t = \frac{(V_y \cdot \bar{z}_b + \bar{M}_{xs})}{(\bar{z}_b - \bar{z}_t)}$$

$$V_t = \frac{(28.28 \cdot 0.206 + 4.589)}{((0.206 + 0.21))}$$

$$V_t = \underline{\underline{25.04 \text{ kN}}}$$

Limiting plastic internal forces according to [1], Table 10.17

$$V_{pl,t} = \tau_{Rd} \cdot b_t \cdot t_t$$

$$V_{pl,t} = 12.60 \cdot 30.0 \cdot 2.0$$

$$V_{pl,t} = \underline{755.80 \text{ kN}}$$

$$M_{xp,t} = M_{xp} \cdot \frac{I_{T,t}}{I_T}$$

$$M_{xp,t} = \underline{0.00 \text{ kNm}}$$

$$M_{pl,xp,t} = \frac{\tau_{Rd} \cdot t_t^2 \cdot (2 \cdot b_t - t_t)}{4}$$

$$M_{pl,xp,t} = \frac{12.60 \cdot 2.0^2 \cdot (2 \cdot 30.0 - 2.0)}{4}$$

$$M_{pl,xp,t} = \underline{730.61 \text{ kNcm}}$$

Check according to [1], Table 10.17

$$\tau_t = \frac{|M_{xp,t}|}{2 \cdot M_{pl,xp,t}} + \sqrt{\left(\frac{M_{xp,t}}{2 \cdot M_{pl,xp,t}}\right)^2 + \left(\frac{V_t}{V_{pl,t}}\right)^2} \cdot \frac{f_{y,d}}{\sqrt{3}}$$

$$\tau_t = \frac{|0.00|}{2 \cdot 730.61} + \sqrt{\left(\frac{0.00}{2 \cdot 730.61}\right)^2 + \left(\frac{25.04}{755.80}\right)^2} \cdot \frac{f_{y,d}}{\sqrt{3}} = \underline{0.417 \text{ kN/cm}^2}$$

$$\Rightarrow \frac{\tau_t}{\tau_{Rd}} = \underline{0.03} \leq 1.00$$

8.2.3 Shear Resistance in Web

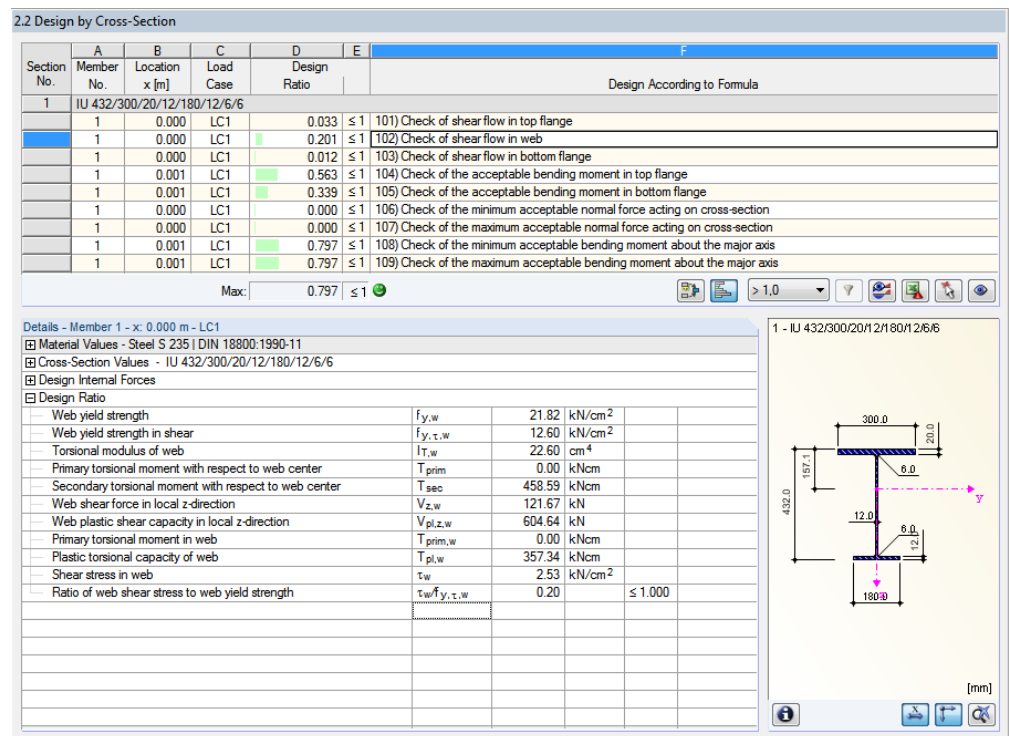

Figure 8.9: Check of shear resistance in web

Partial internal forces in cross-section parts according to [1], Table 10.17

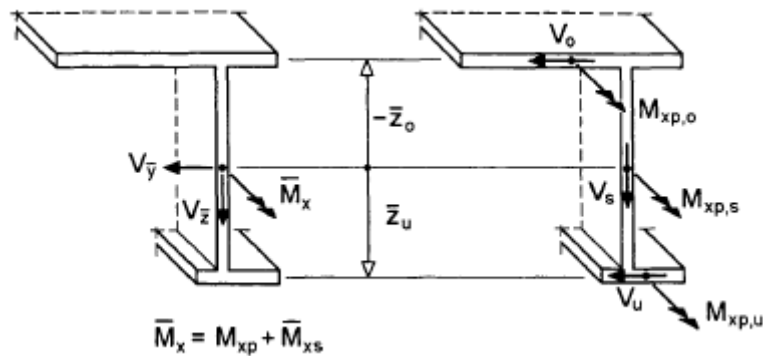

Figure 8.10: Partial internal forces τ in cross-section consisting of three plates according to Figure 10.40 [1]

$$V_w = V_z$$

$$V_w = \underline{\underline{121.67 \text{ kN}}}$$

Limiting plastic internal forces according to [1], Table 10.17

$$V_{pl,w} = \tau_{Rd} \cdot h_w \cdot t_w$$

$$V_{pl,w} = 12.60 \cdot 40.0 \cdot 1.2$$

$$V_{pl,w} = \underline{\underline{604.64 \text{ kN}}}$$

$$M_{xp,w} = M_{xp} \cdot \frac{I_{T,w}}{I_T}$$

$$M_{xp,w} = \underline{\underline{0.00 \text{ kNm}}}$$

$$M_{pl,xp,w} = \frac{\tau_{Rd} \cdot t_w^2 \cdot (2 \cdot h_w - t_w)}{4}$$

$$M_{pl,xp,w} = \frac{12.60 \cdot 1.2^2 \cdot (2 \cdot 40.0 - 1.2)}{4}$$

$$M_{pl,xp,w} = \underline{\underline{357.34 \text{ kNcm}}}$$

Check according to [1], Table 10.17

$$\tau_s = \frac{|M_{xp,w}|}{2 \cdot M_{pl,xp,w}} + \sqrt{\left(\frac{M_{xp,w}}{2 \cdot M_{pl,xp,w}}\right)^2 + \left(\frac{V_w}{V_{pl,w}}\right)^2} \cdot \frac{f_{y,d}}{\sqrt{3}}$$

$$\tau_s = \frac{|0,00|}{2 \cdot 357.34} + \sqrt{\left(\frac{0.00}{2 \cdot 357.34}\right)^2 + \left(\frac{121.67}{604.64}\right)^2} \cdot \frac{f_{y,d}}{\sqrt{3}} = \underline{\underline{2.54 \text{ kN/cm}^2}}$$

$$\Rightarrow \frac{\tau_w}{\tau_{Rd}} = \underline{\underline{0.20}} \leq 1.00$$

8.2.4 Shear Resistance in Bottom Flange

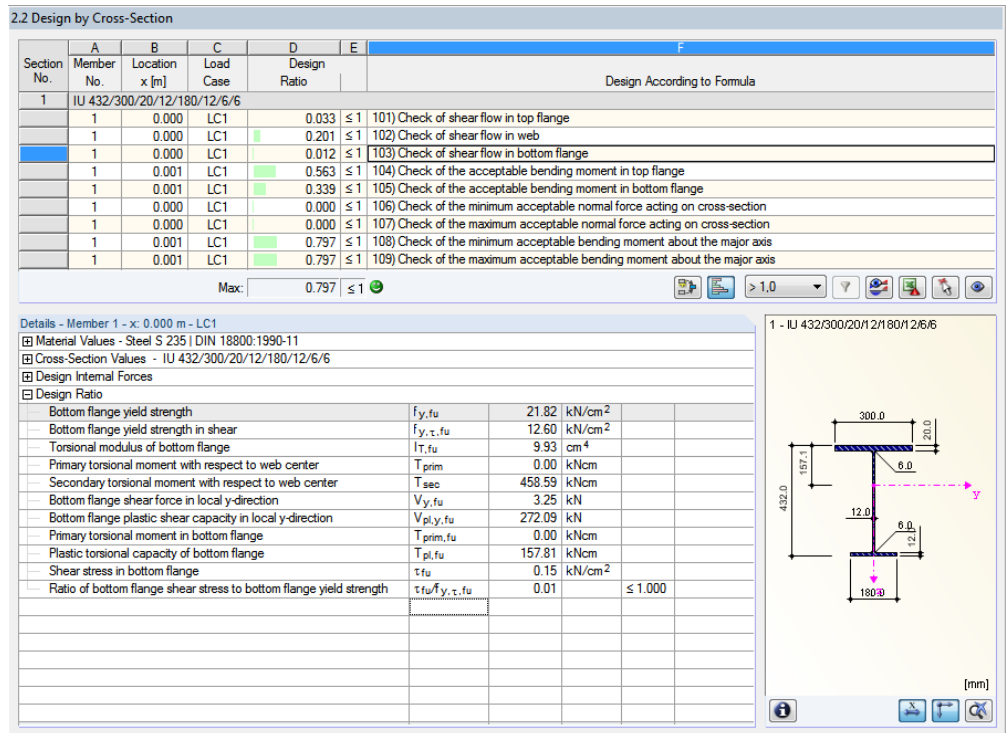

Figure 8.11: Check of shear resistance in top flange

Partial internal forces in cross-section parts according to [1], Table 10.17

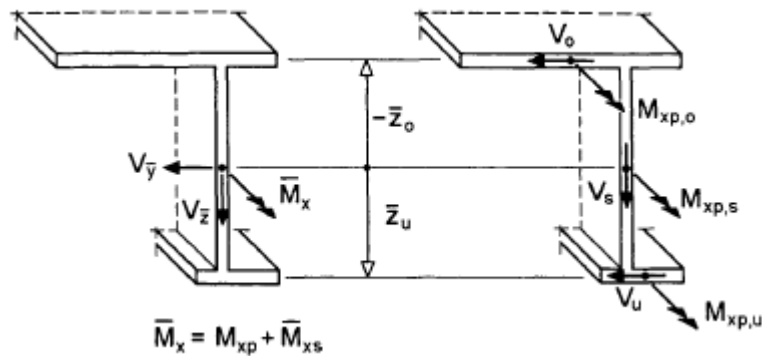

Figure 8.12: Partial internal forces τ in cross-section consisting of three plates according to Figure 10.40 [1]

$$V_U = \frac{-(V_y \cdot \bar{z}_t + \bar{M}_{x_s})}{(\bar{z}_b - \bar{z}_t)}$$

$$V_U = \frac{-(28.28 \cdot 0.21 + 4.589)}{((0.206 + 0.21))}$$

$$V_U = \underline{\underline{3.24 \text{ kN}}}$$

Limiting plastic internal forces according to [1], Table 10.17

$$V_{pl,b} = \tau_{Rd} \cdot b_b \cdot t_b$$

$$V_{pl,b} = 12.60 \cdot 18.0 \cdot 1.2$$

$$V_{pl,b} = \underline{\underline{272.09 \text{ kN}}}$$

$$M_{xp,b} = M_{xp} \cdot \frac{I_{T,b}}{I_T}$$

$$M_{xp,b} = \underline{\underline{0.00 \text{ kNm}}}$$

$$M_{pl,xp,b} = \frac{\tau_{Rd} \cdot t_b^2 \cdot (2 \cdot b_b - t_b)}{4}$$

$$M_{pl,xp,b} = \frac{12.60 \cdot 1.2^2 \cdot (2 \cdot 18.0 - 1.2)}{4}$$

$$M_{pl,xp,b} = \underline{\underline{157.81 \text{ kNcm}}}$$

Check according to [1], Table 10.17

$$\tau_b = \frac{|M_{xp,b}|}{2 \cdot M_{pl,xp,b}} + \sqrt{\left(\frac{M_{xp,b}}{2 \cdot M_{pl,xp,b}}\right)^2 + \left(\frac{V_t}{V_{pl,b}}\right)^2} \cdot \frac{f_{y,d}}{\sqrt{3}}$$

$$\tau_b = \frac{|0.00|}{2 \cdot 157.81} + \sqrt{\left(\frac{0.00}{2 \cdot 157.81}\right)^2 + \left(\frac{3.24}{272.09}\right)^2} \cdot \frac{f_{y,d}}{\sqrt{3}} = \underline{\underline{0.151 \text{ kN/cm}^2}}$$

$$\Rightarrow \frac{\tau_b}{\tau_{Rd}} = \underline{\underline{0.012}} \leq 1.00$$

8.2.5 Check of Allowable Bending Moment in Top Flange

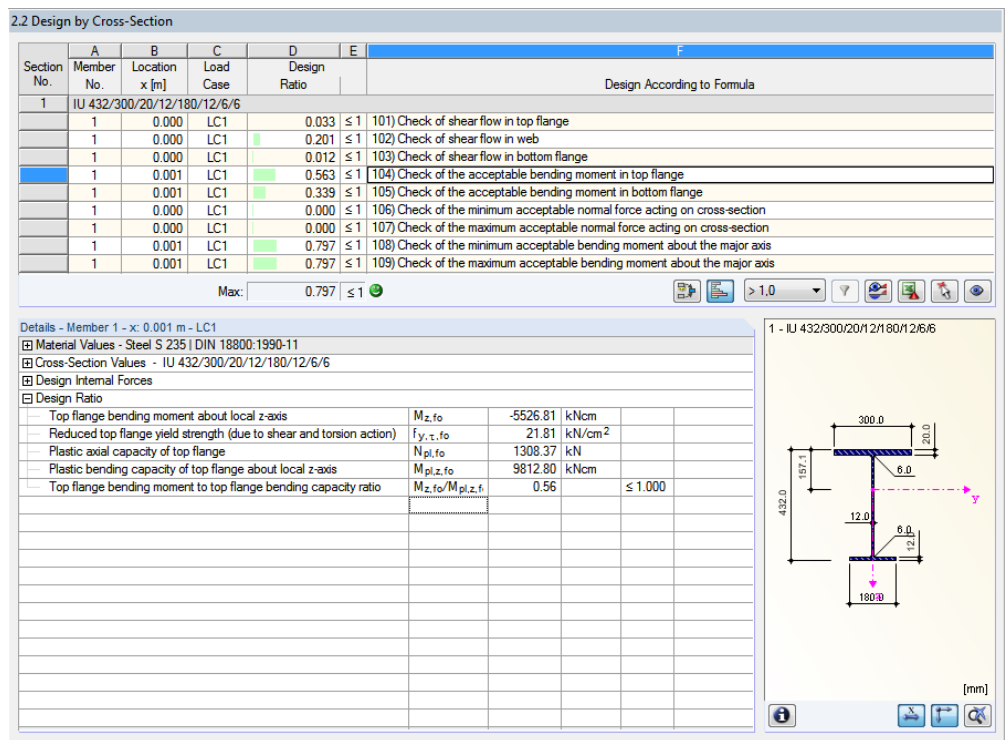

Figure 8.13: Check of the allowable bending moment at top flange

Partial internal forces in cross-section parts according to [1], Table 10.20

$$M_{Sa,t} = \frac{(M_z \cdot \bar{z}_b - M_o)}{(\bar{z}_b - \bar{z}_t)}$$

$$M_{Sa,t} = \frac{(-6245 \cdot 0.206 - 101,339)}{(0.206 + 0.21)}$$

$$M_{Sa,t} = \underline{\underline{-5528.50 \text{ kNcm}}}$$

$$N_{pl,t,\tau} = b_t \cdot t_t \cdot f_{y,d} \cdot \sqrt{1 - \left(\frac{\tau_t}{\tau_{Rd}}\right)^2}$$

$$N_{pl,t,\tau} = 30.0 \cdot 2.0 \cdot 21.82 \cdot \sqrt{1 - (0.033)^2}$$

$$N_{pl,t,\tau} = \underline{\underline{1308.37 \text{ kN}}}$$

Limiting plastic internal forces according to [1], Table 10.20

$$M_{pl,t,\tau} = \frac{N_{pl,o,\tau} \cdot b_o}{4}$$

$$M_{pl,t,\tau} = \frac{1308.37 \cdot 30.0}{4}$$

$$M_{pl,t,\tau} = \underline{\underline{9813.65 \text{ kNcm} = 98.14 \text{ kNm}}}$$

Check according to [1], Table 10.9

$$\frac{|M_{Sa,t}|}{M_{pl,t,\tau}} \leq 1 + \delta_t^2 \Rightarrow \delta_t = 2 \cdot \bar{y}_t / b_t = \underline{\underline{0.0 \text{ cm}}}$$

$$\frac{|-5528.50|}{9813.65} = \underline{\underline{0.563}} \leq 1.00$$

8.2.6 Check of Allowable Bending Moment in Bottom Flange

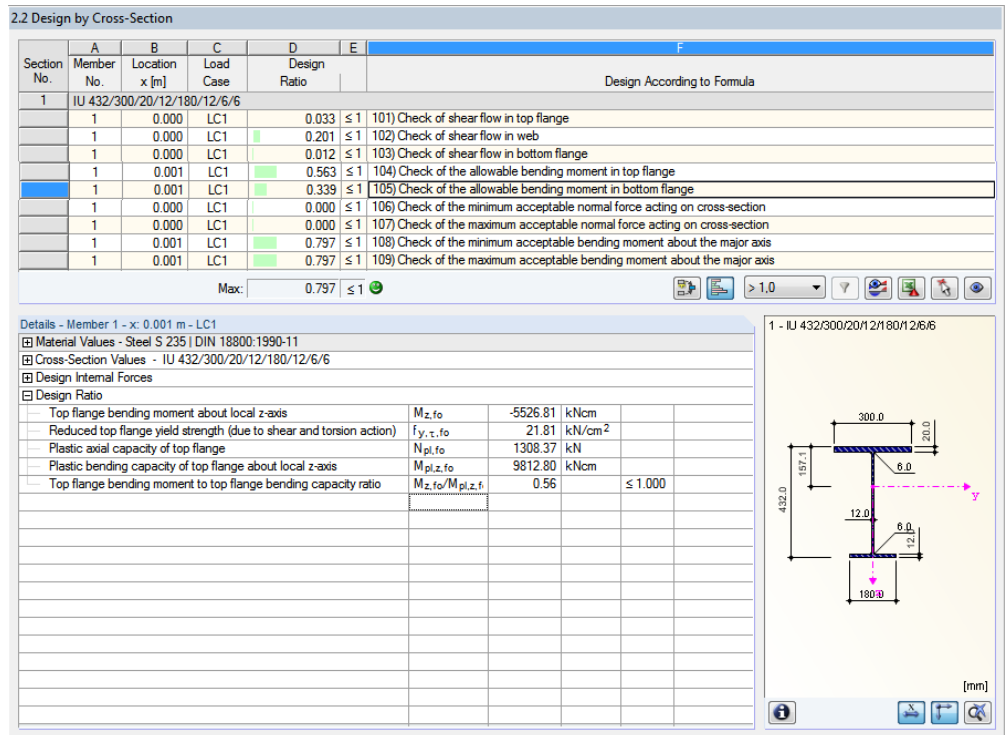

Figure 8.14: Check of allowable bending moment in bottom flange

Partial internal forces in cross-section parts according to [1], Table 10.20

$$M_{Sa,b} = \frac{(-M_z \cdot \bar{z}_t + M_{\omega})}{(z_b - \bar{z}_t)}$$

$$M_{Sa,b} = \frac{(6245 \cdot (-21.0) + 101,339)}{(20.6 + 21.0)}$$

$$M_{Sa,b} = \underline{\underline{-716.49 \text{ kNcm}}}$$

$$N_{pl,b,\tau} = b_b \cdot t_b \cdot f_{y,d} \cdot \sqrt{1 - \left(\frac{\tau_b}{\tau_{Rd}}\right)^2}$$

$$N_{pl,b,\tau} = 18.0 \cdot 1.2 \cdot 21.82 \cdot \sqrt{1 - (0.012)^2}$$

$$N_{pl,b,\tau} = \underline{\underline{471.24 \text{ kN}}}$$

Limiting plastic internal forces according to [1], Table 10.20

$$M_{pl,b,\tau} = \frac{N_{pl,b,\tau} \cdot b_b}{4}$$

$$M_{pl,b,\tau} = \frac{471.24 \cdot 18.0}{4}$$

$$M_{pl,b,\tau} = \underline{\underline{2120.58 \text{ kNcm} = 21.21 \text{ kNm}}}$$

Check according to [1], Table 10.9

$$\frac{|M_{Sa,b}|}{M_{pl,b,\tau}} \leq 1 + \delta_b^2 \Rightarrow \delta_b = 2 \cdot \bar{y}_b / b_b = \underline{\underline{0.0 \text{ cm}}}$$

$$\frac{|-716.49|}{2120.58} = \underline{\underline{0.338 \leq 1.00}}$$

8.2.7 Check of Allowable Bending Moment

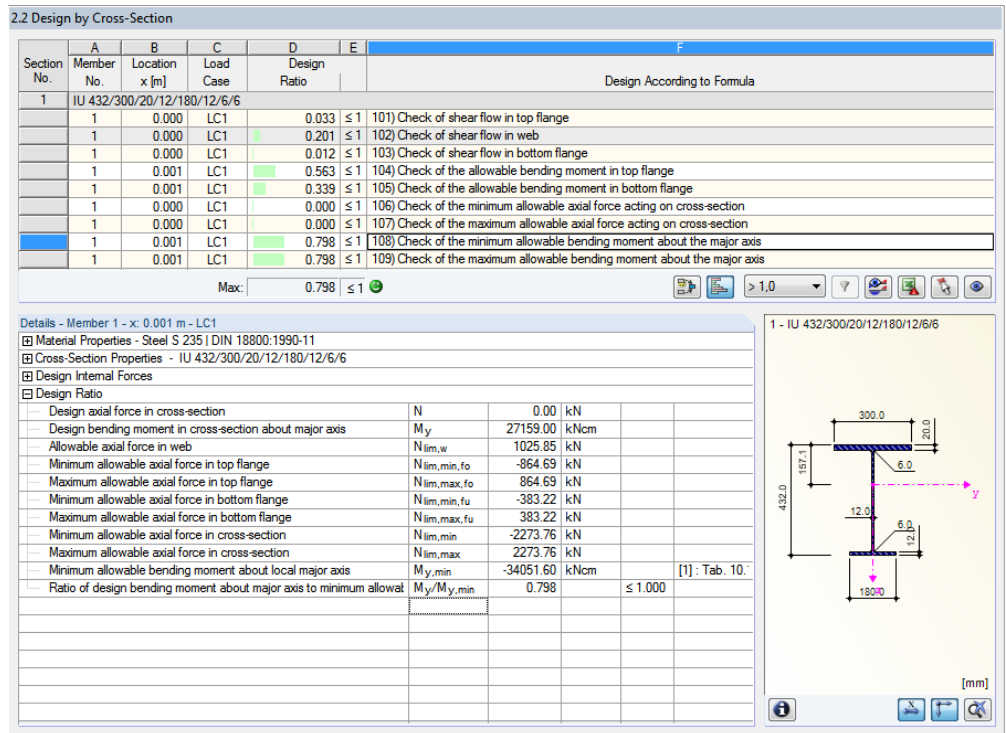

Figure 8.15: Check of allowable bending moment about major axis

Limiting axial forces in flanges according to [1], Table 10.18

$$\frac{M_{Sa,t}}{M_{pl,t,\tau}} = 0.563 \geq 2 \cdot \delta_t = 0.0$$

$$N_{lim,t,min} = N_{pl,t,\tau} \cdot \left(-\delta_t - \sqrt{\delta_t^2 + 1 - \left(\frac{M_{Sa,t}}{M_{pl,t,\tau}} \right)} \right)$$

$$N_{lim,t,min} = 1308.87 \cdot \left(-0.0 - \sqrt{0.0^2 + 1 - 0.563} \right)$$

$$N_{lim,t,min} = -864.52 \text{ kN} \Rightarrow N_{lim,t,max} = 864.52 \text{ kN}$$

$$\frac{M_{Sa,b}}{M_{pl,b,\tau}} = 0.339 \geq 2 \cdot \delta_b = 0.0$$

$$N_{lim,b,min} = N_{pl,b,\tau} \cdot \left(-\delta_b - \sqrt{\delta_b^2 + 1 - \left(\frac{M_{Sa,b}}{M_{pl,b,\tau}} \right)} \right)$$

$$N_{lim,b,min} = 471.24 \cdot \left(-0.0 - \sqrt{0.0^2 + 1 - 0.339} \right)$$

$$N_{lim,b,min} = -383.45 \text{ kN} \Rightarrow N_{lim,b,max} = 383.45 \text{ kN}$$

Limiting axial force according to [1], Table 10.20

$$N_{lim,w,max} = h_w \cdot t_w \cdot f_{y,d} \cdot \sqrt{1 - \left(\frac{\tau_w}{\tau_{Rd}} \right)^2}$$

$$N_{lim,w,max} = 40.0 \cdot 1.2 \cdot 21.82 \cdot \sqrt{1 - 0.201^2}$$

$$N_{lim,w,max} = 1025.85 \text{ kN}$$

Governing case according to [1], Table 10.19

Because $N = 0$, all possible cases for determining $\max M_y$ are met. Therefore, the limiting bending moments are determined for all three cases. The minimum value is governing.

- **Case 1:**

$$\begin{aligned} \min M_y &= N_{\text{lim},b,\text{min}} \cdot (\bar{z}_b - \bar{z}_t) + (N + N_{\text{lim},w}) \cdot \bar{z}_t \\ \min M_y &= -383.45 \cdot (0.206 - (-0.21)) + (0.00 + 1025.85) \cdot (-0.21) \\ \min M_y &= \underline{\underline{-374.94 \text{ kNm}}} \end{aligned}$$

- **Case 2:**

$$\begin{aligned} N_w &= N - N_{\text{lim},t,\text{max}} - N_{\text{lim},b,\text{min}} \\ N_w &= 0.00 - 864.52 - (-383.45) \\ N_w &= \underline{\underline{-481.07 \text{ kN}}} \\ \min M_y &= N_{\text{lim},b,\text{min}} \cdot \bar{z}_b + N_{\text{lim},t,\text{max}} \cdot \bar{z}_t - \frac{(N_{\text{lim},w}^2 - N_w^2) \cdot h_w}{(4 \cdot N_{\text{lim},w})} \\ \min M_y &= -383.45 \cdot 0.206 + 864.52 \cdot (-0.21) - \frac{(1025.85^2 - 481.07^2) \cdot 0.40}{(4 \cdot 1025.85)} \\ \min M_y &= \underline{\underline{-340.57 \text{ kNm}}} \Rightarrow \text{governing} \end{aligned}$$

- **Case 3:**

$$\begin{aligned} \min M_y &= -N_{\text{lim},t,\text{max}} \cdot (\bar{z}_b - \bar{z}_t) + (N - N_{\text{lim},w}) \cdot \bar{z}_b \\ \min M_y &= -864.52 \cdot (0.206 - (-0.21)) + (0.00 - 1025.85) \cdot (0.206) \\ \min M_y &= \underline{\underline{-570.97 \text{ kNm}}} \end{aligned}$$

Check according to [1], Table 10.19

$$\begin{aligned} \frac{M_y}{\min M_y} &\leq 1.00 \\ \frac{27,159.00}{34,057.00} &= \underline{\underline{0.797}} \leq 1.00 \end{aligned}$$

8.3 Circular Hollow Section

The following example is presented in [1], page 446.

Cross-section

Cross-section pipe 273/8

Steel S 235

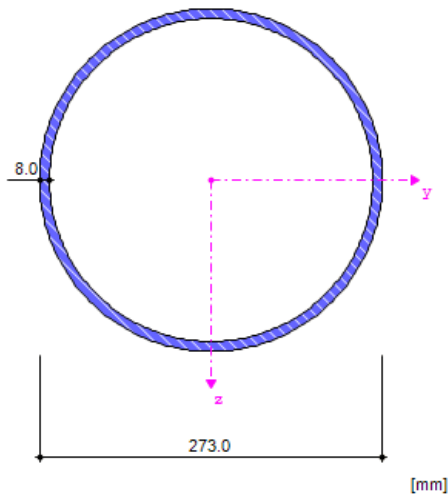

Figure 8.16: Cross-section pipe 273/8

Cross-section properties

Cross-section property	Symbol	Value	Unit
Outer diameter	D	273.000	mm
Wall thickness	s	8.000	mm
Cross-sectional area	A	66.600	cm ²
Shear area	A _y	33.040	cm ²
Core area	A _c	551.550	cm ²
Moment of inertia	I _y	5851.710	cm ⁴
Polar moment of inertia	I _p	8275.570	cm ⁴
Governing radius of gyration	r _y	93.700	mm
Polar radius of gyration	r _o	132.600	mm
Weight	wt	52.300	kg/m
Surface	A _{surf}	0.858	m ² /m
Torsional constant	J	11,692.800	cm ⁴
Section modulus for torsion	S _t	856.610	cm ³
Elastic section modulus	S _y	428.700	cm ³
Statical moment of area	Q _{y,max}	140.490	cm ³
Plastic section modulus	Z _{y,max}	561.970	cm ³

Table 8.3: Cross-section properties for pipe 273/8

Loading

$$\text{Shear force } V_{Ed} = 116.00 \text{ kN}$$

$$\text{Moment } M_{T,Ed} = 40.00 \text{ kNm}$$

$$\text{Moment } M_{y,Ed} = 100.00 \text{ kNm}$$

8.3.1 Check of Shear Resistance

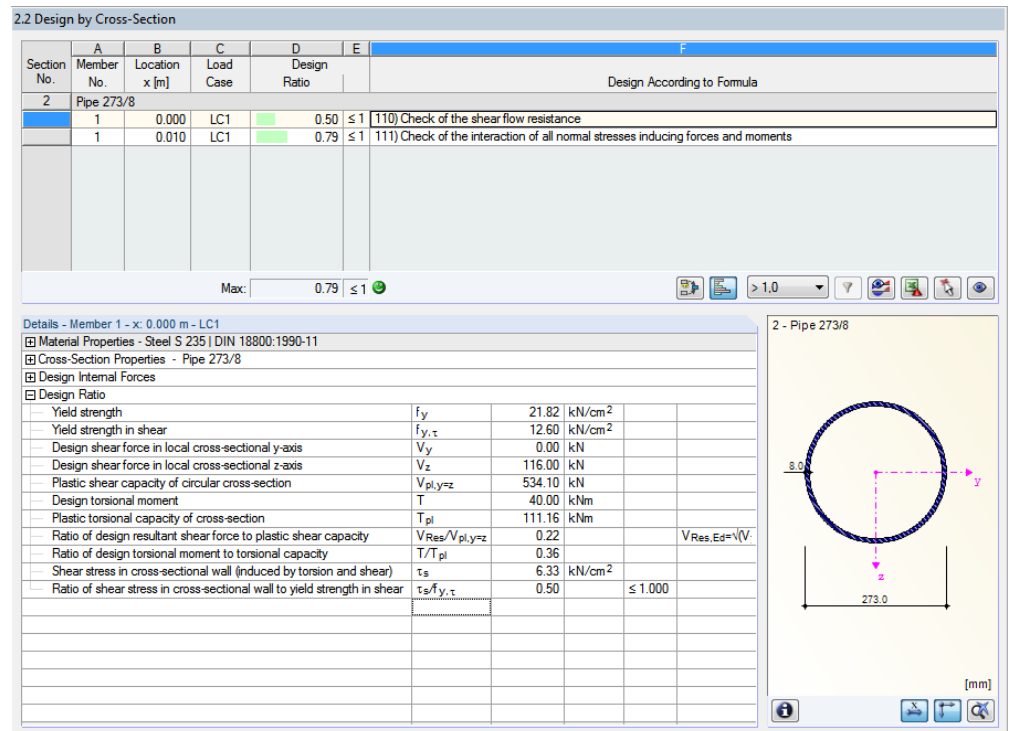

Figure 8.17: Check of shear resistance

Material properties

$$f_{y,d} = \frac{f_{y,k}}{\gamma_M} = \frac{24.00}{1.1} = \underline{\underline{21.82 \text{ kN/cm}^2}}$$

$$\tau_{Rd} = \frac{f_{y,d}}{\sqrt{3}} = \frac{21.82}{\sqrt{3}} = \underline{\underline{12.60 \text{ kN/cm}^2}}$$

Limiting plastic internal forces according to [1], Table 10.10

$$V_{pl,y,z} = 2 \cdot \frac{f_{y,d}}{\sqrt{3}} \cdot t \cdot (d - t)$$

$$V_{pl,y,z} = 2 \cdot \frac{21.82}{\sqrt{3}} \cdot 0.8 \cdot (27.30 - 0.8)$$

$$V_{pl,y,z} = \underline{\underline{534.10 \text{ kN}}}$$

$$M_{pl,x} = \pi \cdot \frac{f_{y,d}}{\sqrt{3}} \cdot t \cdot (d - t)^2 / 2$$

$$M_{pl,x} = \pi \cdot \frac{21.82}{\sqrt{3}} \cdot 0.8 \cdot (27.30 - 0.8)^2 / 2$$

$$M_{pl,x} = \underline{\underline{11,116.28 \text{ kNcm} = 111.16 \text{ kNm}}}$$

Check according to [1], Table 10.10

The check conditions given in Table 10.10 apply to the linear interaction. In RF-STEEL Plastic, however, the iterative method of the exact solution is implemented. Thus, you obtain higher resistances for this example than given in [1].

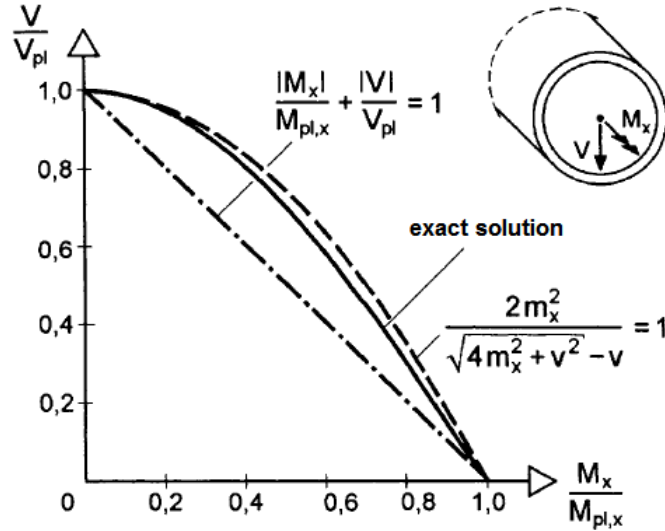

Figure 8.18: M_x - V interaction (exact solution and approximations)

Linear interaction

$$\tau = \frac{|V|}{V_{pl}} + \frac{|M_x|}{M_{pl,x}} \cdot \frac{f_{y,d}}{\sqrt{3}}$$

$$\tau = \frac{|116|}{534.10} + \frac{|40|}{116.16} \cdot \frac{f_{y,d}}{\sqrt{3}} = 7.25 \text{ kN/cm}^2$$

$$\Rightarrow \frac{\tau}{\tau_{Rd}} = \underline{\underline{0.57}} \leq 1.00$$

Exact solution

$$\tau = 6.33 \text{ kN/cm}^2 \Rightarrow \frac{\tau}{\tau_{Rd}} = \underline{\underline{0.50}} \leq 1.00$$

8.3.2 Interaction of Normal and Bending Stresses

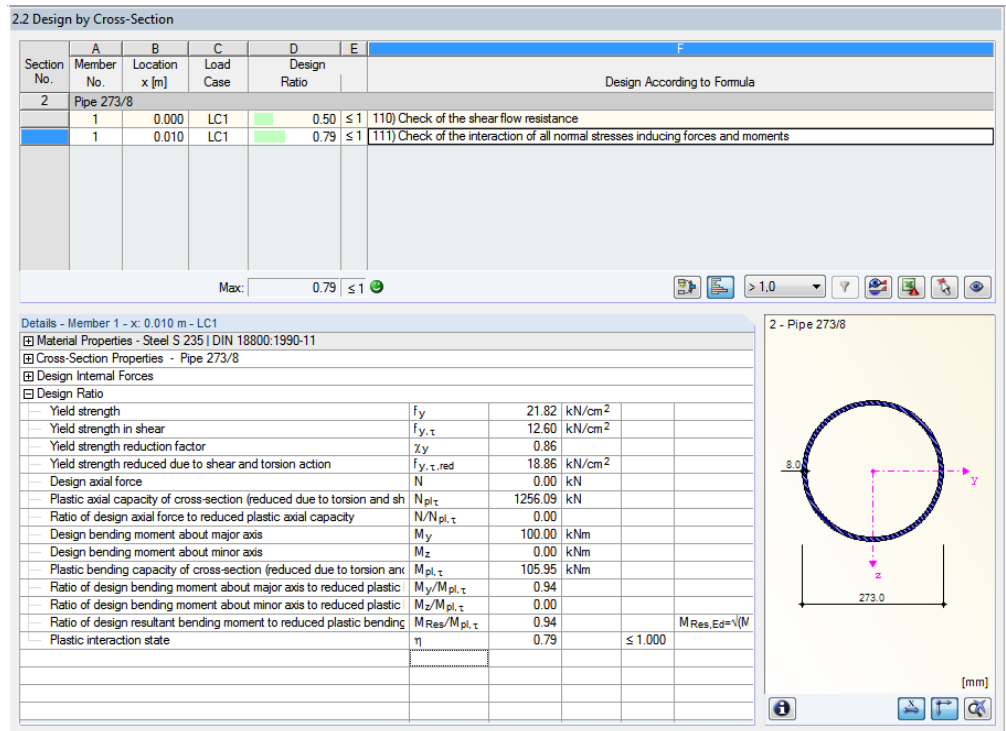

Figure 8.19: Interaction check of normal and bending stresses

Reduction factor of yield strength

$$\chi_y = \sqrt{1 - \left(\frac{\tau}{\tau_R}\right)^2} = \sqrt{1 - 0.504^2} = \underline{\underline{0.864}}$$

$$\text{red}f_y = f_y \cdot \chi_y = 21.82 \cdot 0.864 = \underline{\underline{18.86 \text{ kN/cm}^2}}$$

Limiting plastic internal forces according to [1], Table 10.10

$$N_{pl,\tau} = \pi \cdot t \cdot (d - t) \cdot \text{red}f_y$$

$$N_{pl,\tau} = \pi \cdot 0.8 \cdot (27.30 - 0.8) \cdot 18.86$$

$$N_{pl,\tau} = \underline{\underline{1256.09 \text{ kN}}}$$

$$M_{pl,\tau} = t \cdot (d - t)^2 \cdot \text{red}f_y$$

$$M_{pl,\tau} = 0.8 \cdot (27.30 - 0.8)^2 \cdot 18.86$$

$$M_{pl,\tau} = 10595.55 \text{ kNcm} = \underline{\underline{105.96 \text{ kNm}}}$$

Check according to [1], Table 10.10

$$\frac{N}{N_{pl,\tau}} + \frac{2}{\pi} \cdot \arcsin\left(\frac{|M|}{M_{pl,\tau}}\right) \leq 1.00$$

$$\frac{0.00}{1256.09} + \frac{2}{\pi} \cdot \arcsin\left(\frac{|100|}{105.96}\right) \leq 1.00$$

$$\underline{\underline{0.79 \leq 1.00}}$$

8.4 Rectangular Hollow Section

The following example is presented in [1], page 458.

Cross-section

Rectangular hollow section TO 300/200/8

Steel S 355

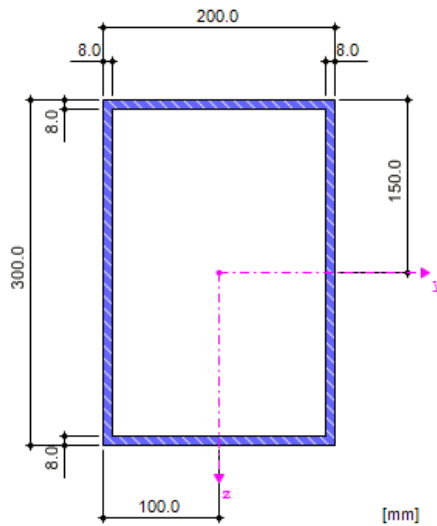

Figure 8.20: Rectangular hollow section TO 300/200/8

Cross-section properties

Cross-section property	Symbol	Value	Unit
Depth	a	300.000	mm
Width	b	200.000	mm
Left wall thickness	t_{al}	8.000	mm
Right wall thickness	t_{ar}	8.000	mm
Upper wall thickness	t_{bt}	8.000	mm
Lower wall thickness	t_{bb}	8.000	mm
Cross-sectional area	A	77.440	cm ²
Shear area	A_y	22.840	cm ²
Shear area	A_z	41.800	cm ²
Core area	A_c	560.640	cm ²
Moment of inertia	I_y	9877.000	cm ⁴
Moment of inertia	I_z	5256.840	cm ⁴
Polar moment of inertia	I_p	15,133.800	cm ⁴
Governing radius of gyration	r_y	112.900	mm
Governing radius of gyration	r_z	82.400	mm
Polar radius of gyration	r_o	139.800	mm
Weight	wt	60.800	kg/m
Surface	$A_{surface}$	1.000	m ² /m
Torsional constant	J	10,407.200	cm ⁴
Warping constant referring to M	C_w	21,647.200	cm ⁶

Elastic section modulus	S_y	658.470	cm ³
Elastic section modulus	S_z	525.680	cm ³
Warping section modulus	W_w	747.520	cm ⁴
Statical moment of area	$Q_{y,max}$	197.460	cm ³
Statical moment of area	$Q_{z,max}$	149.060	cm ³
Normalized warping constant	W_{no}	28.960	cm ²
Warping statical moment	$Q_{w,max}$	149.810	cm ⁴
Plastic section modulus	$Z_{y,max}$	789.820	cm ³
Plastic section modulus	$Z_{z,max}$	596.220	cm ³
Plastic shape factor	$Z_{y,max}/S_y$	1.199	
Plastic shape factor	$Z_{z,max}/S_z$	1.134	

Table 8.4: Cross-section properties TO 300/200/8

Loading

Shear force	V_{Ed}	=	48.00 kN
Moment	$M_{T,Ed}$	=	24.00 kNm
Moment	$M_{y,Ed}$	=	240.00 kNm

8.4.1 Shear Resistance in Flanges

2.2 Design by Cross-Section

Section No.	Member No.	Location x [m]	Load Case	Design Ratio	E
1	TO 300/200/8/8/8/8				
1	1	0.000	LC1	0.14 ≤ 1	114) Check of resistance of shear flow in flanges
1	1	0.000	LC1	0.20 ≤ 1	115) Check of resistance of shear flow in webs
1	1	0.000	LC1	0.94 ≤ 1	116) Check of the interaction of all normal stress inducing forces and moments

Max: 0.94 ≤ 1

Details - Member 1 - x: 0.000 m - LC1

- Material Values - Steel S 355 | DIN 18800:1990-11
- Cross-Section Values - TO 300/200/8/8/8/8
- Design Internal Forces
- Design Ratio

Idealized webs height	h_w	292.0	mm
Idealized webs thickness	t_w	8.0	mm
Idealized flanges width	b_f	192.0	mm
Idealized flanges thickness	t_f	8.0	mm
Top and bottom flanges yield strength	$f_{y,\tau,f}$	32.73	kN/cm ²
Top and bottom flanges yield strength in shear	$f_{y,\tau,f}$	18.90	kN/cm ²
Design shear force in local cross-sectional y-axis	V_y	0.00	kN
Design torsional moment	T	24.00	kNm
Flange shear force due to internal distribution	$V_{y,f}$	41.10	kN
Top and bottom flanges plastic shear capacity in local z-direction	$V_{pl,z,f}$	290.23	kN
Shear stress in top and bottom flanges	τ_f	1.34	kN/cm ²
Shear stress in flange to flange yield strength in shear	$\tau_f/f_{y,\tau,f}$	0.14	≤ 1.000

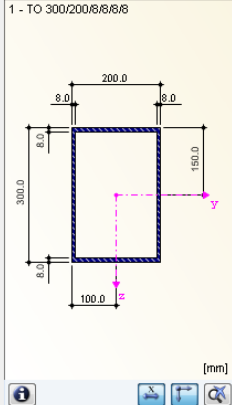

Figure 8.21: Check of shear resistance in flanges

Material properties

$$f_{y,d} = \frac{f_{y,k}}{\gamma_M} = \frac{36.00}{1.1} = \underline{\underline{32.73 \text{ kN/cm}^2}}$$

$$\tau_{Rd} = \frac{f_{y,d}}{\sqrt{3}} = \frac{32.73}{\sqrt{3}} = \underline{\underline{18.90 \text{ kN/cm}^2}}$$

Limiting plastic internal forces according to [1], Table 10.14

$$V_{pl,flange} = 2 \cdot b \cdot t_G \cdot \frac{f_{y,d}}{\sqrt{3}} \qquad V_{pl,web} = 2 \cdot h_w \cdot t_w \cdot \frac{f_{y,d}}{\sqrt{3}}$$

$$V_{pl,flange} = 2 \cdot 19.20 \cdot 0.80 \cdot \frac{32.73}{\sqrt{3}} \qquad V_{pl,web} = 2 \cdot 29.20 \cdot 0.80 \cdot \frac{32.73}{\sqrt{3}}$$

$$V_{pl,flange} = \underline{\underline{580.46 \text{ kN}}} \qquad V_{pl,web} = \underline{\underline{883.00 \text{ kN}}}$$

Partial internal forces in cross-section parts

$$V_{flange} = \frac{|V_y|}{2} + \frac{|M_x| \cdot b}{2 \cdot a_g \cdot a_s} \qquad V_{web} = \frac{|V_z|}{2} + \frac{|M_x| \cdot h_w}{2 \cdot a_f \cdot a_w}$$

$$V_{flange} = \frac{|0.00|}{2} + \frac{|24| \cdot 0.192}{2 \cdot 0.292 \cdot 0.192} \qquad V_{web} = \frac{|48.00|}{2} + \frac{|24| \cdot 0.292}{2 \cdot 0.292 \cdot 0.192}$$

$$V_{flange} = \underline{\underline{41.10 \text{ kN}}} \qquad V_{web} = \underline{\underline{86.50 \text{ kN}}}$$

Check according to [1], Table 10.14

$$\tau_f = \left(V_y + \frac{M_x \cdot b}{a_f \cdot a_w} \right) \cdot \frac{1}{V_{pl,y}} \cdot \frac{f_{y,d}}{\sqrt{3}}$$

$$\tau_f = \left(0.00 + \frac{24.00 \cdot 0.192}{0.292 \cdot 0.192} \right) \cdot \frac{1}{580.46} \cdot 18.90 = 2.68 \text{ kN/cm}^2$$

$$\Rightarrow \frac{\tau_f}{\tau_{Rd}} = \underline{\underline{0.14}} \leq 1.00$$

8.4.2 Shear Resistance in Web

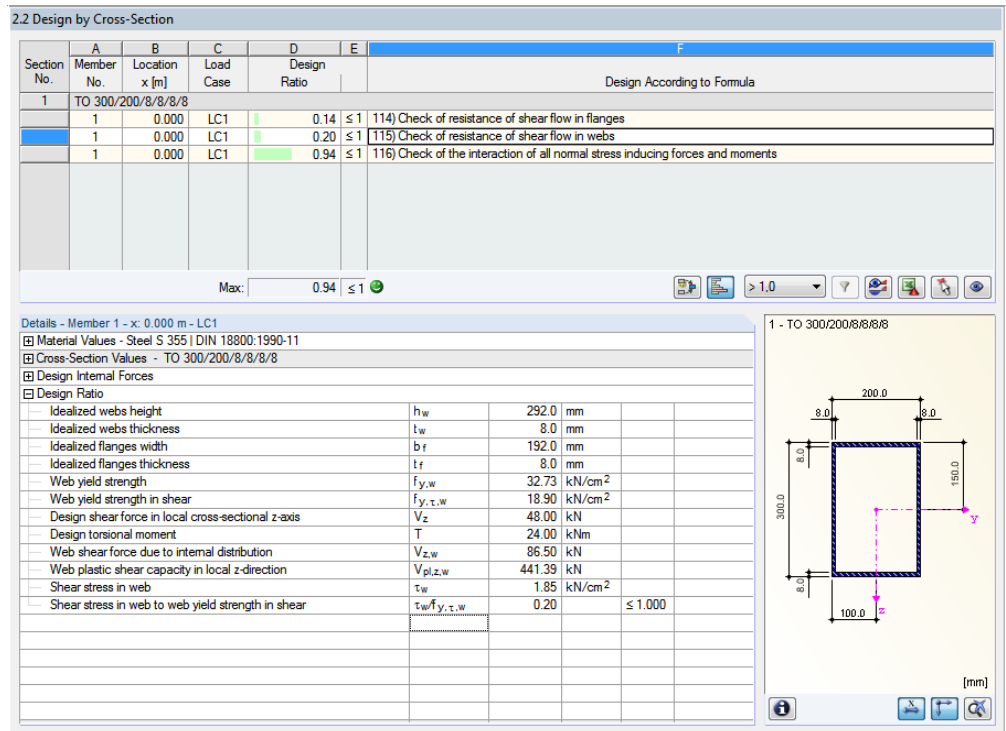

Figure 8.22: Check of shear resistance in web

Check according to [1], Table 10.14

$$\tau_w = \left(V_z + \frac{M_x \cdot h_w}{a_f \cdot a_w} \right) \cdot \frac{1}{V_{pl,z}} \cdot \frac{f_{y,d}}{\sqrt{3}}$$

$$\tau_w = \left(48.00 + \frac{24.00 \cdot 0.292}{0.292 \cdot 0.192} \right) \cdot \frac{1}{883.00} \cdot 18.90 = 3.70 \text{ kN/cm}^2$$

$$\Rightarrow \frac{\tau_w}{\tau_{Rd}} = \underline{\underline{0.20}} \leq 1.00$$

8.4.3 Interaction of Normal and Bending Stresses

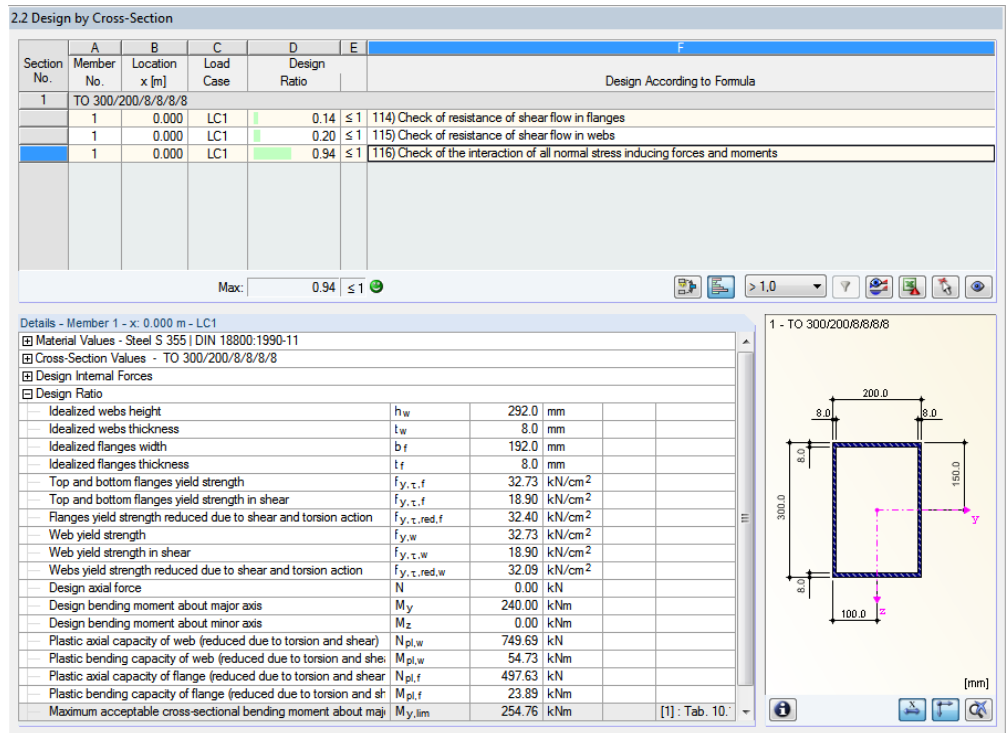

Figure 8.23: Interaction check of normal and bending stresses

Reduction factors of yield strength according to [1], Table 10.15

$$red f_{y,f} = f_{y,f} \cdot \sqrt{1 - \left(\frac{\tau_f}{\tau_{Rd}}\right)^2} = 32.73 \cdot \sqrt{1 - 0.14^2} = \underline{\underline{32.40 \text{ kN/cm}^2}}$$

$$red f_{y,w} = f_{y,w} \cdot \sqrt{1 - \left(\frac{\tau_w}{\tau_{Rd}}\right)^2} = 32.73 \cdot \sqrt{1 - 0.20^2} = \underline{\underline{32.09 \text{ kN/cm}^2}}$$

Limiting plastic internal forces according to [1], Table 10.15

$$N_{pl,f} = red f_y \cdot b \cdot t_f \qquad N_{pl,w} = red f_y \cdot h_w \cdot t_w$$

$$N_{pl,f} = 32.40 \cdot 192 \cdot 0.8 \qquad N_{pl,w} = 32.09 \cdot 292 \cdot 0.8$$

$$N_{pl,f} = \underline{\underline{497.66 \text{ kN}}} \qquad N_{pl,w} = \underline{\underline{749.62 \text{ kN}}}$$

Check according to [1], Table 10.15 – case 1a

$$M_{pl,y} = N_{pl,f} \cdot a_f + \frac{h_w}{2 \cdot N_{pl,w}} \cdot \left[N_{pl,w}^2 - \frac{N^2}{4} - \left(\frac{M_z}{a_f}\right)^2 \right]$$

$$M_{pl,y} = 497.66 \cdot 0.292 + \frac{0.292}{2 \cdot 749.62} \cdot \left[749.62^2 - \frac{0^2}{4} - \left(\frac{0}{0.192}\right)^2 \right]$$

$$M_{pl,y} = 254.76 \text{ kNm} \geq 240.00 \text{ kNm}$$

Design ratio: $\underline{\underline{0.94}} \leq 1.00$

A Literature

- [1] Rolf KINDMANN, Jörg FRICKEL: Elastische und plastische Querschnittstragfähigkeit Grundlagen, Methoden, Berechnungsverfahren, Ernst & Sohn, Berlin, 2002
- [2] Plastic interaction relations for elliptical hollow sections, Farhood NOWZARTASH, Magdi MOHAREB, Thin-Walled Structures, 47 (2009), p. 681-691
- [3] SHAPE-THIN 7 user manual, Dlubal Software GmbH, February 2012.

B Index

B		H	
Background graphic.....	31	Hidden result diagram	34
Browse through windows	8	I	
Buttons	30	Info about cross-section	14
C		Installation	6
Calculation.....	16	Internal forces	26, 41
Calculation options	16	L	
Clipboard	43	Length	28
Color bar.....	30	Load case	9, 26
Color spectrum	34	Load combination	9
Colored design.....	34	Location x	22
Comment.....	9	M	
Control panel.....	34	Material	10, 43
Cross-section	12, 40	Material description.....	10
Cross-section library.....	12	Material library.....	11
Cross-section optimization	40	Material properties.....	10
Cross-section type	13	Maximum	13
D		Members.....	9
Decimal places	10, 42	N	
Design	9, 21, 22, 23	Navigator	8
Design case	31, 38, 39	O	
Design method	13, 18	OpenOffice.....	43
Design ratio	22	Optimization	13, 17, 40, 41
Detail settings	16	P	
Display navigator	32, 34	Panel.....	7, 32, 34
E		Parametric section.....	40
Elliptical cross-section	18	Partial internal forces.....	18
Excel.....	43	Partial Internal Forces Method	4, 13, 18
Exit RF-STEEL Plastic.....	8	Partial safety factor	16
Export.....	43	Parts list	28, 29
Export cross-section.....	41	PIFM.....	18
Export material.....	43	Position	28
F		Print	36
Favorite.....	40	Printout report.....	36, 37
Filter	30, 34	Program start	6
Filtering members.....	35	R	
G		Remark	14
General	17	Rendering.....	34
General data.....	8	Result combination	9, 30
Graphic printout.....	36	Result diagram.....	33, 36
Graphics	31	Result tables	17

Result values	31
Results display	32
Results evaluation	30
Results windows	17, 21
RFEM graphic	36
RFEM work window	31

S

Set of members	9, 24, 27, 29
Settings	16
Simplex Method	16, 19
Start calculation	20
Start RF-STEEL Plastic	6
Stress point	15
Sum	29
Surface area	28

T

Taper	14, 23, 41
-------------	------------

U

Ultimate limit state	9
Units	10, 42
User-profile	42

V

View mode	30, 31
Visibilities	34
Volume	29

W

Weight	29
Windows	8

X

x-location	22, 26
------------------	--------