

Version
October 2013

Add-on Module

CONCRETE Columns (ACI)

Method Based on Nominal Curvature
According to ACI 318-11 / EN 1992-1-1

Program Description

All rights, including those of translations, are reserved.

No portion of this book may be reproduced – mechanically, electronically, or by any other means, including photocopying – without written permission of DLUBAL SOFTWARE GMBH.

© **Dlubal Software GmbH**

Am Zellweg 2 D-93464 Tiefenbach

Tel.: +49 9673 9203-0

Fax: +49 9673 9203-51

E-Mail: info@dlubal.com

Web: www.dlubal.com

Contents

Contents		Page	Contents		Page
1.	Introduction	5	4.6.1	Design Method	45
1.1	About CONCRETE Columns	5	4.6.2	Design Shear Resistance Without Shear Reinforcement	46
1.2	The Team	6	4.6.3	Design Shear Resistance with Shear Reinforcement	47
2.	Installation	6	4.6.4	Variants of the Check of Shear Force	50
3.	Module CONCRETE Columns	7	4.6.5	Check of Shear Force	51
4.	Theoretical Background	9	4.6.5.1	Cracked Cross-Section	51
4.1	Stability Analysis	9	4.6.5.2	Fully Compressed Cross-Section	54
4.1.1	Requirement of Analysis	9	4.6.6	Check of Shear Force in Circular Cross-Section	55
4.1.2	Form of the Analysis	9	4.6.6.1	Cracked Cross-Section	55
4.1.3	Classification of the Structural System	9	4.6.6.2	Fully Compressed Cross-Section	58
4.1.4	Determination of the Equivalent Member Length	10	4.6.7	Shear Reinforcement	58
4.1.5	Determination of the Slenderness	11	4.6.8	Program Flow of Shear Analysis	61
4.1.6	Stability Analysis or Standard Design	12	4.6.8.1	Part 5.1: Determination of the Shear Resistance	62
4.1.7	First Order and Second Order Bending Moments	12	4.6.8.2	Part 5.2 : Determination of the Compression Strut's Strength	64
4.1.7.1	First Order Intended Eccentricity	12	4.6.8.3	Part 5.3 : Determination of the Transverse Reinforcement	65
4.1.7.2	Additional unbraced eccentricity e_1	14	4.7	Overlaps	66
4.1.7.3	Additional Eccentricity of Load e_2 from Second Order Deformations	15	4.7.1	Connection Elements on a Column	66
4.1.8	Type of Cross-Section Design	17	4.7.2	Design of Overlaps	68
4.2	Program Flow of the Stability Analysis	17	5.	Working with CONCRETE Columns	71
4.2.1	Part 1: Load Independent Calculations	21	5.1	Open CONCRETE Columns	71
4.2.2	Part 2: Determination of the Governing Load	22	5.2	Windows	72
4.2.3	Part 3: Determination of Provided Reinforcement	27	5.3	Input Windows	73
4.2.4	Part 4: Determining the Provided Safety	31	5.3.1	Window 1.1 General Data	73
4.3	Program Flow of the Check of the Provided Reinforcement	33	5.3.2	Window 1.2 Materials	81
4.4	Determination of the Required Reinforcement	33	5.3.3	Window 3.1 Cross-Sections	86
4.4.1	Rectangular Cross-Section	34	5.3.4	Window 1.4 Reinforcement	88
4.4.2	Circular cross-section	36	5.3.5	Fire Resistance	96
4.5	Fire Resistance Design	38	5.3.6	Window 1.5 Column Parameters - by Members	98
4.5.1	Subdivision of Cross-Section	38	5.4	Details	111
4.5.2	Reduction of Cross-Section	39	5.5	Results Windows	115
4.5.3	Stress-Strain Curve of Concrete	41	5.5.1	Window 2.1 Check	115
4.5.4	Stress-Strain Curve of Reinforcing Steel	42	5.5.2	Window 3.1 Required Reinforcement by Cross-Section	127
4.6	Check of Shear Force	45			

Contents

Contents		Page	Contents		Page
5.5.3	Window 3.2 Required Reinforcement by Member	131	8.1.1	Slenderness Effects in Compression Members	187
5.5.4	Window 4.1 Longitudinal Reinforcement Provided	132	8.1.1.1	Effective Length	187
5.5.5	Window 4.2 Shear Reinforcement Provided	135	8.1.1.2	Slenderness	188
6.	Results Evaluation	141	8.1.1.3	Limiting Slenderness	188
6.1	Results Display in RSTAB	141	8.1.2	Moment Magnification Procedure	188
6.2	Printout	145	8.1.2.1	Minimum Eccentricity	188
7.	Examples	151	8.1.2.2	Braced Frame (Nonsway)	189
7.1	Edge Column	151	8.1.2.3	Unbraced Frame (Sway)	189
7.1.1	System and Loads	151	8.1.3	Strength Analysis of Flexure and Axial Force	190
7.1.2	Design Values of Limit States	152	8.1.3.1	Basic Conditions	190
7.1.3	Spatial Stiffness and Stability	156	8.1.3.2	Stress-Strain Diagrams	190
7.1.4	Effective Length and Slenderness	156	8.1.3.3	Strength Reduction Factor	191
7.1.5	Further Specifications in the Module	157	8.1.3.4	Maximum Axial Strength	191
7.1.6	Required Reinforcement	161	8.1.4	Minimum Reinforcement	191
7.1.7	Limiting Slenderness	163	8.1.5	Maximum Reinforcement	191
7.1.8	Eccentricities	164	8.1.6	Shear Design	192
7.1.9	Moments According to First Order Theory	164	8.1.6.1	Basic Equation	192
7.1.10	Second order moments	165	8.1.6.2	Shear Strength Provided by Concrete	192
7.1.11	Statically Required Reinforcement	166	8.1.6.3	Shear Strength Provided by Shear Reinforcement	193
7.1.12	Provided Reinforcement	166	8.1.7	Construction Requirements	194
7.1.13	Provided Safety	167	8.1.7.1	Ties and Stirrups	194
7.2	Slender Column	170	8.1.7.2	Longitudinal Reinforcement	194
7.2.1	Spatial Stiffness and Stability	171	8.1.7.3	Development of the Reinforcement	194
7.2.2	Effective Length and Slenderness of the Column	171	8.1.7.4	Factors for Development Length	196
7.2.3	Limiting Slenderness According to 5.8.3.1(1)	173	8.2	Data Input for ACI 318-11	197
7.2.4	Intended Eccentricity According to 5.8.8.2	175	A:	Literature	204
7.2.5	Eccentricity due to Imperfections According to 5.2	175			
7.2.6	Minimum Eccentricity According to 6.1.(4)	176			
7.2.7	Moments According to First Order Theory	176			
7.2.8	Second Order Moments	176			
7.2.9	Provided Reinforcement	181			
7.3	Fire Resistance Design	183			
8.	ACI 318-11	187			
8.1	Design According to ACI 318	187			

1. Introduction

1.1 About CONCRETE Columns

Dear user of CONCRETE Columns,

this add-on module extends our RSTAB program family. It is an additional powerful tool for reinforced concrete design. As known from other Dlubal programs, you can select members or continuous members with a rectangular or round cross-section from the generated structure and use the load of these structural components for the design. You can comfortably define the constructive properties of the columns and set specifications to determine the required longitudinal and shear reinforcement.

When you have started the calculation, the program will determine which load will be governing for the design of bending and shear resistance. In the design of the bending resistance, the program determines whether a standard design is sufficient or should be calculated with the moments according to second-order theory. In both cases, a biaxial bending design is possible, for which an exact strain-stress-diagram of the cross-section is displayed spatially. In all, five governing locations of the column are analyzed for the check of safety against bending failure. These are the locations of the minimum axial force and the locations with the respective minimum and maximum moments about both principal axes of the cross-section. For the shear resistance, the locations of the column with extreme shear forces in a direction of axis are considered.

Finally, a reinforcement proposal is shown for the longitudinal and shear reinforcement taking into account all structural regulations. This reinforcement is shown three-dimensionally and in graphics designed according to regulations. It can be modified according to your individual needs.

This modified reinforcement is then reused to determine the quantitative value of the safety against bending and shear failure.



In this manual, the theoretical background is described in chapter 4 which refers to the regulations according to EN 1992-1-1 (Eurocode). As for ACI 318, chapter 8 contains detailed information on the design of concrete columns according to the U.S. code.

If you have any suggestions regarding this program, please do not hesitate to contact us.

We hope you will enjoy working with the add-on module CONCRETE Columns.

Your team from DLUBAL SOFTWARE GMBH

1.2 The Team

The following people were involved in the development of **CONCRETE Columns**:

Program coordination

Dipl.-Ing. Georg Dlubal
 Dipl.-Ing. (FH) Alexander Meierhofer

Dipl.-Ing. (FH) Younes El Frem

Programming

Ing. Michal Balvon
 Ing. Ladislav Ivančo
 Ing. Alexandr Průcha

Ing. Jana Vlachová
 Jaroslav Bartoš

Program development and supervision

Dipl.-Ing. (FH) Alexander Meierhofer
 Ing. Jan Fráňa
 Ing. Pavel Gruber

Ing. Jana Vlachová
 Ing. Bohdan Šmid

Manual, help system, and translation

Dipl.-Ing. (FH) Alexander Meierhofer
 M.Sc. Dipl.-Ing. Frank Lobisch
 Dipl.-Ing. Frank Faulstich
 Dipl.-Ü. Gundel Pietzcker

Mgr. Petra Pokorná
 Ing. Bohdan Šmid
 Dipl.-Ing. (FH) Robert Vogl

Technical support and quality management

Dipl.-Ing. (BA) Markus Baumgärtel
 Dipl.-Ing. Moritz Bertram
 Dipl.-Ing. (FH) Steffen Clauß
 Dipl.-Ing. Frank Faulstich
 Dipl.-Ing. (FH) René Flori
 Dipl.-Ing. (FH) Stefan Frenzel
 Dipl.-Ing. (FH) Walter Fröhlich
 Dipl.-Ing. (FH) Andreas Hörold

Dipl.-Ing. (FH) Bastian Kuhn
 Dipl.-Ing. (FH) Alexander Meierhofer
 M. Eng. Dipl.-Ing. (BA) Andreas Niemeier
 M.Eng. Dipl.-Ing. (FH) Walter Rustler
 Dipl.-Ing. (FH) Frank Sonntag
 Dipl.-Ing. (FH) Christian Stautner
 Dipl.-Ing. (FH) Robert Vogl
 Dipl.-Ing. (FH) Andreas Wopperer

2. Installation

You can find the system requirements for your computer in the current RSTAB manual.

The program family RSTAB is delivered on DVD. This DVD contains not only the main program RSTAB but also all add-on modules belonging to the RSTAB program family, among them **CONCRETE Columns**. Thus, all programs related to RSTAB are included on this DVD.

You can find further information on the installation process in the current RSTAB manual.

3. Module CONCRETE Columns

Following DLUBAL'S product philosophy, the internal forces are determined by creating a model and the respective load in the main program RSTAB and computing them subsequently. The design of this model's components and the internal forces acting in them is performed in the respective add-on module. Therefore, the following two questions must be addressed in this add-on module:

- Which components of the model are to be designed?
- For which loads are these components to be designed?

The components of the model designed with the add-on module **CONCRETE Columns** can be **members** as well as **continuous members**.

The following figure shows the basic difference between a simple **member** and **continuous members**.

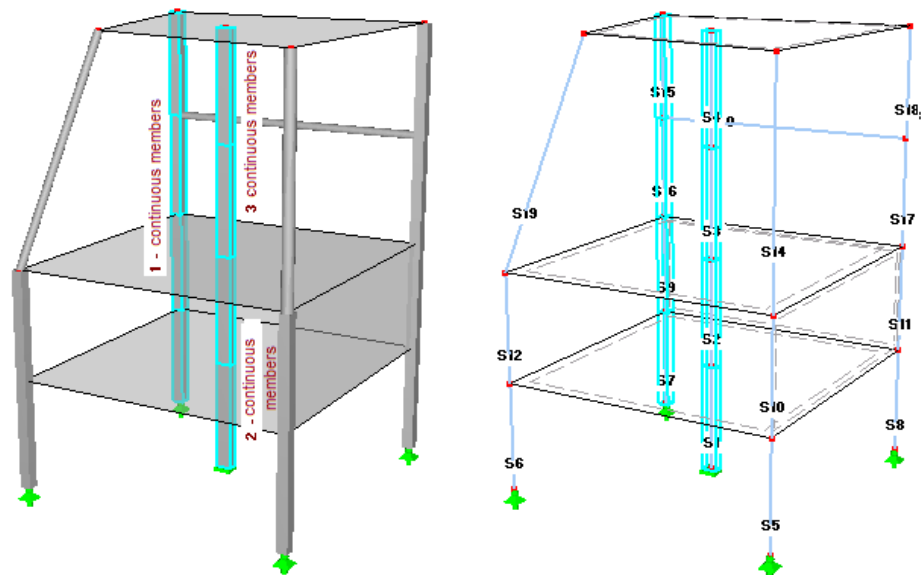


Figure 3.1: Members and continuous members

Continuous members consist of several connected members that do not branch out. The left figure shows three sets of continuous members. Continuous members 1 reach from the support to the highest plate and consist of four single members. Continuous members 2 and 3 consist of two individual members, respectively. The numbers of these individual members can be seen in the wire-frame model to the right.

By entering the number of continuous members or a single member in the add-on module **CONCRETE Columns**, you can select it for design.

The load used for the design is determined by selecting one of the previously defined load cases, load combinations, and result combinations.

By selecting a member or continuous members, you give the add-on module CONCRETE Columns information on the structural component to be designed that you entered while creating a model in RSTAB. Notice:

Information	Member	Continuous members
Material	Only the common types of concrete specified by the current standard are allowed.	All members of the continuous members must consist of the same material; otherwise the program will exclude them.
Cross-section	Only rectangular and round cross-section types are allowed.	All members in the continuous members must have the same cross-section.
Length of the system	The length of the system is the length of the line used for the definition of the member.	The length of the system is the sum of the lengths of lines used for the definition of members of the continuous members.
Connecting slab/column	All surfaces and/or members that have a point that is at the same time a start or end point of the line used for the definition of the member.	What has been said for the individual member applies for each member that is part of continuous members.

4. Theoretical Background

4.1 Stability Analysis

4.1.1 Requirement of Analysis



The following conditions or equations refer to EN 1992-1-1:2010 [2]. As for ACI 318, chapter 8 contains detailed information on the design according to the U.S. code.

The deformations of certain structural components, for example columns, show a significant influence on the magnitude of the internal forces. According to EN 1992-1-1:2010 clause 5.8.2, a significant influence is given if the internal forces (second order effects) determined accounting for the deformation differ by 10% or more than the internal forces of the undeformed system (first order effects) or if the slenderness $\lambda > \lambda_{lim}$ according to clause 5.8.3.1.

In such a case, the standard design is not sufficient. A stability analysis is required. The "Method based on nominal curvature" (EN 1992-1-1:2010, clause 5.8.8), is a simple analysis method to this end. It can be used for compression elements as

- Isolated members
- Parts of a frame construction.

The nonlinear analysis of the system's structural behavior allows for the most exact evaluation of the frame structure. However, this analysis is very cumbersome. The method based on nominal curvature, on the other hand, is a good approximation procedure.

4.1.2 Form of the Analysis

In designing according to the method based on nominal curvature, you decompose a structural system in order to analyze the individual compression elements in equivalent members or an equivalent member is chosen for an isolated column. For these equivalent members, the internal forces are determined according to second-order theory based on the simplified assumption of a parabolic curvature of the column.

The form of the analysis corresponds with a standard cross-section design.

The cross-section is designed for the following internal forces:

- Axial force N_{Ed}
- Moment M_{Ed2}

where

- N_{Ed} : Applied axial force
- M_{Ed2} : Second order moment M_{Ed2} determined from a model column (bracket) in the point of fixity

4.1.3 Classification of the Structural System

Before the equivalent member of a structural system can be defined, it is necessary to determine the type of the structural system.

EN 1992-1-1:2010, clause 5.8.3.3, distinguishes between two structural systems:

- Braced structural components
- Unbraced structural components

To analyze the horizontal bracing, you need knowledge of the construction (shear walls, building cores). This information is not immediately discernible from the generated structure. Therefore, you have to specify whether the structural system is horizontally braced or unbraced.

4.1.4 Determination of the Equivalent Member Length

Standard	Clause
EN 1992-1-1:2010	5.8.3.2

The length (effective length) l_0 of an equivalent member - whether this equivalent member was determined from an isolated column or a column that is part of a frame structure - is defined as follows:

$$l_0 = \beta \cdot l$$

where

- β : Ratio of the equivalent length to the column length l_0
- l : Length of the centroidal axis of a column

The ratio β for the isolated columns can be determined from the defined support with the aid of the following table values.

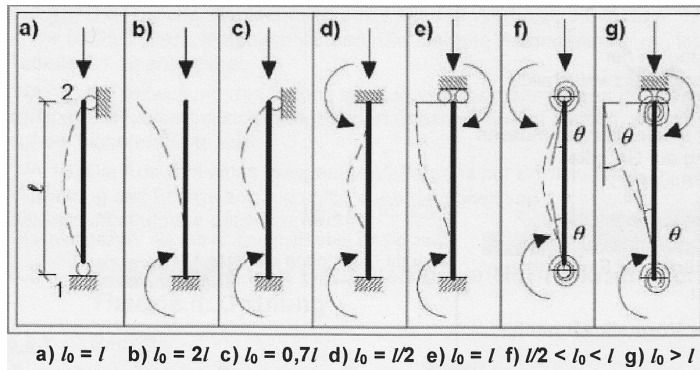


Figure 4.1: Length (effective length) l_0 of an equivalent member

If support springs were defined, you have to define the value β .

If, however, the compression element to be analyzed is part of a framework system, the following nomograms according to ENV 1992-1-1 can be used to determine the ratio β :

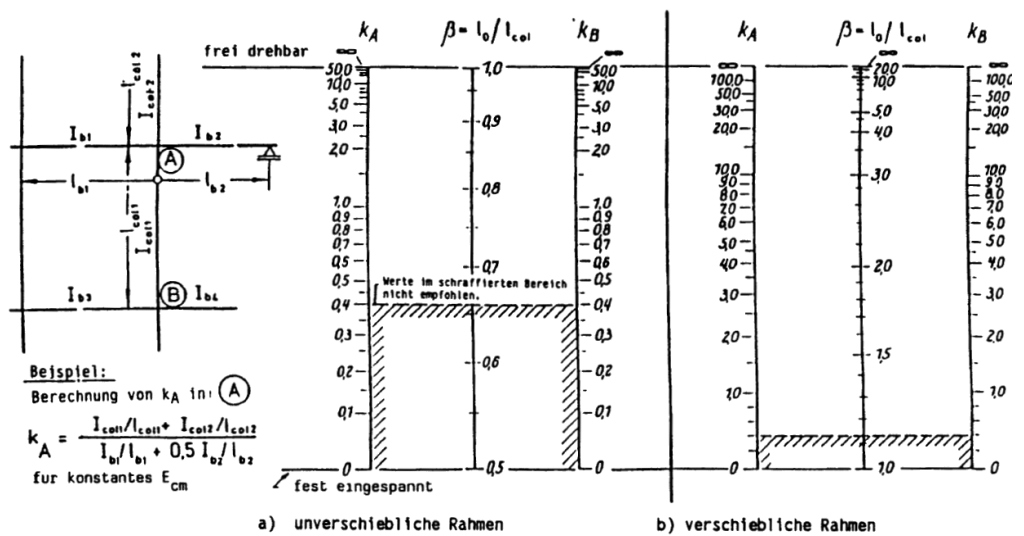


Bild 4.27 Nomogramm für die Berechnung der Ersatzlänge

$$k_A \text{ (oder } k_B) = \frac{\sum E_{cm} \cdot I_{col} / l_{col}}{\sum E_{cm} \cdot \alpha \cdot I_b / l_{eff}}$$

Seite 100
ENV 1992-1-1:1991
(4.60)

Figure 4.2: Nomograms to determine the ratio β

In order to be able to determine k_A and k_B in the program automatically, you basically only have to determine the buckling direction for the compression element to be analyzed. In this direction, the program automatically determines the

- connecting columns
- connecting beams
- support conditions of the connecting beams on the remote end

For each of these columns and beams, the program already has the information about the moduli of elasticity, moments of inertia, and lengths.

If necessary, you can select the connecting columns and beams individually.

A compression member can buckle in several directions. In the case of different support conditions in the respective directions, different equivalent lengths can result for each direction.

The ratio β is only an approximation and can therefore only be defined by the user.

4.1.5 Determination of the Slenderness

Standard	Clause
EN 1992-1-1:2010	5.8.3.2 (1)

Upon determination of the equivalent member length l_0 of the individual compression elements, you can determine their slenderness λ .

$$\lambda = \frac{l_0}{i}$$

where

i: Radius of gyration

$$i = \sqrt{\frac{I}{A}}$$

4.1.6 Stability Analysis or Standard Design

A stability analysis is required only for compression elements. For compact compression elements, the standard design is sufficient. Whether a compression member is to be classified as "slender" or "compact" is defined by comparison with the so-called limiting slenderness λ_{lim} according to EN 1992-1-1:2010. If the existing slenderness is smaller than the limiting slenderness, the standard design is sufficient.

The limiting slenderness λ_{lim} is given as:

EN 1992-1-1:2010 Clause. 5.8.3.1 (1)
$\lambda \leq \lambda_{lim}$
$\lambda_{lim} = 20 \cdot A \cdot B \cdot C / \sqrt{n}$ <p>where:</p> $A = 1 / (1 + 0.2 \cdot \phi_{ef})$ $B = \sqrt{1 + 2 \cdot \omega}$ $C = 1.7 - r_m$ <p>and:</p> $n = \frac{N_{Ed}}{A_c \cdot f_{cd}}, f_{cd} = \frac{\alpha \cdot f_{ck}}{\gamma_c}$ $\omega = \frac{A_s \cdot f_{yd}}{A_c \cdot f_{cd}}$

The limiting slenderness λ_{lim} depends on the provided reinforcement (see factor B). To obtain the most economical reinforcement, the equation for λ_{lim} is converted to A_s , thus determining the required amount of reinforcement $A_{s,lim}$ that is needed to carry out the standard design. During the iteration, this "limiting longitudinal reinforcement" is used as a comparative value to compute the required longitudinal reinforcement.

$$\lambda_{lim} = 20 \cdot A \cdot C \cdot \frac{1}{\sqrt{n}} \cdot \sqrt{1 + 2 \frac{A_s \cdot f_{yd}}{A_c \cdot f_{cd}}} \xrightarrow{\lambda = \lambda_{lim}} A_{s,lim} = \left[\left(\frac{\lambda \cdot \sqrt{n}}{20 \cdot A \cdot C} \right)^2 - 1 \right] \cdot \frac{A_c \cdot f_{cd}}{2 \cdot f_{yd}}$$

4.1.7 First Order and Second Order Bending Moments

4.1.7.1 First Order Intended Eccentricity

If the moment diagram along the column is constant, the intended eccentricity e_0 is given by the following expression:

$$e_0 = \frac{M_{Ed}}{N_{Ed}} \geq e_{min}, \quad e_{01} = e_{02}$$

where:

$$e_{min} = h / 30 \geq 20\text{mm} \quad \text{Minimum eccentricity according to clause 6.1(4)}$$

h: Depth of cross-section

If, however, the moment distribution is linearly variable, we may determine the equivalent eccentricity e_e .

$$e_e = \max \left\{ \begin{array}{l} 0.6 \cdot e_{02} + 0.4 \cdot e_{01} \\ 0.4 \cdot e_{02} \end{array} \right\} \text{ where } |e_{02}| \geq |e_{01}| \text{ and } (e_{01}, e_{02} \text{ with signs})$$

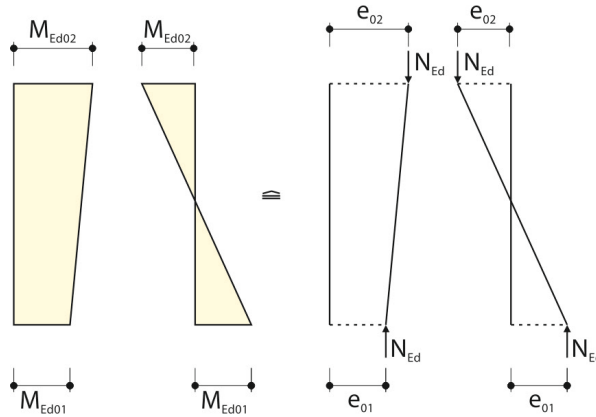


Figure 4.3: Variable moment diagram

Then, this equivalent eccentricity e_e substitutes the intended eccentricity e_0 in the previous equations.

No specifications are given for a , for example, parabolic moment diagram. Therefore, the highest eccentricity is always used to calculate any given moment diagram. Due to this assumption we do not have to exclude columns under certain loads for the design.

The highest eccentricity is also used for the calculation if biaxial bending is acting on the column or the moments result from a result combination.

A bracket is selected as model column, on which a bending moment M_{Ed0} and an axial force N_{Ed} is acting at the column head. The moment M_{Ed0} is substituted by an eccentrically acting axial force N_{Ed} . Here, e_0 denotes the first order intended eccentricity.

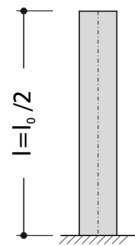


Figure 4.4: Model column - bracket

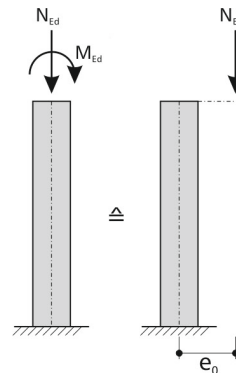


Figure 4.5: Eccentricity e_0

4.1.7.2 Additional unbraced eccentricity e_i

The unavoidable inclination of the column is considered by an end eccentricity e_i .

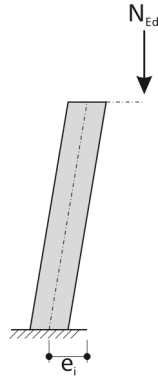


Figure 4.6: End eccentricity e_i

This eccentricity is determined according to EN 1992-1-1: 2010, Expression 5.2:

$$e_i = \Theta_i \cdot l_0 / 2$$

An inclination θ_i is given by Expression (5.1):

$$\Theta_i = \Theta_0 \cdot \alpha_h \cdot \alpha_m$$

$$\Theta_0 = 1 / 200$$

Basic value of inclination

$$\alpha_h = 2 / \sqrt{l} \quad 2/3 \leq \alpha_h \leq 1.0$$

Reduction factor for the height

$$\alpha_m = \sqrt{0.5 \cdot (1 + 1/m)}$$

Reduction factor for the amount of structural components

The bending moment M_{Edi} obtained from inclination e_i is calculated according to EN1992-1-1:2010 clause 5.2 as follows:

$$M_{Edi} = N_{Ed} \cdot e_i$$

Both eccentricities (e_0 and e_i) yield the following moment diagram (first order bending moment).

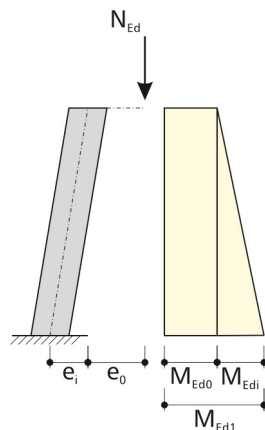


Figure 4.7: First order theory - eccentricities e_i and e_0

4.1.7.3 Additional Eccentricity of Load e_2 from Second Order Deformations

A curvature of the column occurs under the loading. The column head is deflected by the path e_2 . Thus, the second order moment diagram is yielded.

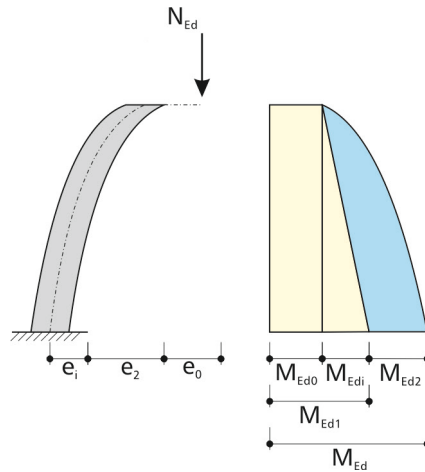


Figure 4.8: Second order analysis - eccentricities e_1 , e_0 , and e_2

In determining the additional deformation, the main idea is the assumption that slender compression elements fail when the yielding in the reinforcement is reached. The starting point is thus the most unfavorable constellation where tension and compression reinforcement reach their yielding stresses at the same time. This is reasonably exact for the zone of tension failure. If, however, compression failure occurs, the ultimate curvature is significantly overestimated. This is considered in the model column method by using the factor K_r , which will be described later in detail.

The curvature is distributed in an unknown form, depending on the stiffnesses changing for every part of the column. In the model column method, however, a parabolic curvature distribution is assumed. Since the moment distribution is affine to the curvature, we now can use the formula, obtained by applying the principle of virtual forces, to determine the eccentricity of load e_2 .

$$e_2 = \left(\frac{1}{r}\right) \cdot l_0^2 / c \quad \text{according to 5.8.8.2(3) EN 1992-1-1:2010}$$

where

$$\left(\frac{1}{r}\right): \quad \text{Member curvature in the governing section}$$

$$\left(\frac{1}{r}\right) = K_r \cdot K_\phi \cdot 1 / r_0 \quad \text{according to 5.8.8.3 EN 1992-1-1:2010}$$

where

K_r : Factor used to consider the decrease of the curvature for longitudinal compression forces. In practice, it is often assumed to be 1 in order to obtain results on the safe side.

$$K_r = \frac{|n_u| - |n|}{|n_u| - |n_{bal}|} \leq 1$$

where

n_u : Related resistance of a structural component under centric loading

$$n_u = 1 + \omega$$

Please note:

It is defined from the provided reinforcement, therefore, iteration is necessary.

where

ω : Mechanical reinforcement ratio

$$\omega = \frac{A_s \cdot f_{yd}}{A_c \cdot f_{cd}}$$

n : Relative axial force

$$n = N_{ed} / (A_c \cdot f_c)$$

n_{bal} : Relative axial compression force in the case of the ultimate moment resistance at a dimensionless cross-section (applies to all rectangular cross-sections with symmetric reinforcement)

$$n_{bal} = 0.4$$

K_ϕ : Factor for taking account of creep effects

$$K_\phi = 1 + \beta \cdot \varphi_{ef} \geq 1$$

where

β : Reduction factor

$$\beta = 0.35 + f_{ck} / 200 - \lambda / 150 \geq 0$$

φ_{ef} : effective creep coefficient

$$\varphi_{ef} = \varphi(\infty, t_0) \cdot M_{0Eqp} / M_{0Ed}$$

where

$\varphi(\infty, t_0)$: Final creep coefficient

M_{0Eqp} : First order bending moment in quasi-permanent load combinations (SLS)

M_{0Ed} : First order bending moment in design load combinations (ULS)

Please note:

Under certain circumstances, it can happen that the ratio of quasi-permanent and design moment is > 1.0 . This fact is accounted for in window 1.1. You can select the corresponding check box or clear the selection.

$$1/r_0 = \varepsilon_{yd} / (0.45 \cdot d)$$

where

ε_{yd} : Design value of the strain in the reinforcement at yielding

$$\varepsilon_{yd} = f_{yd} / E_s$$

d : Depth of the cross-section in the expected direction of stability failure

l_0 : Effective length

$$l_0 = \beta \cdot l$$

c : Factor depending on the curvature distribution according to 5.8.8.2(4)

The total eccentricity e_{tot} is defined as follows.

$$e_{\text{tot}} = e_0 + e_i + e_2$$

The total moment M_{Ed} from first and second order analysis is given as:

$$M_{\text{Ed}} = N_{\text{Ed}} \cdot e_{\text{tot}}$$

The compression element is verified, if a sufficient reinforcement is determined for the moment M_{Ed} and axial force N_{Ed} at the point of fixity.

4.1.8 Type of Cross-Section Design

You must specify about which axes a column is prone to instability risks. Even if there is no moment, the instability risk for compression members is always given due to the unintended eccentricity e .

4.2 Program Flow of the Stability Analysis

The program flow can roughly be divided into four parts:

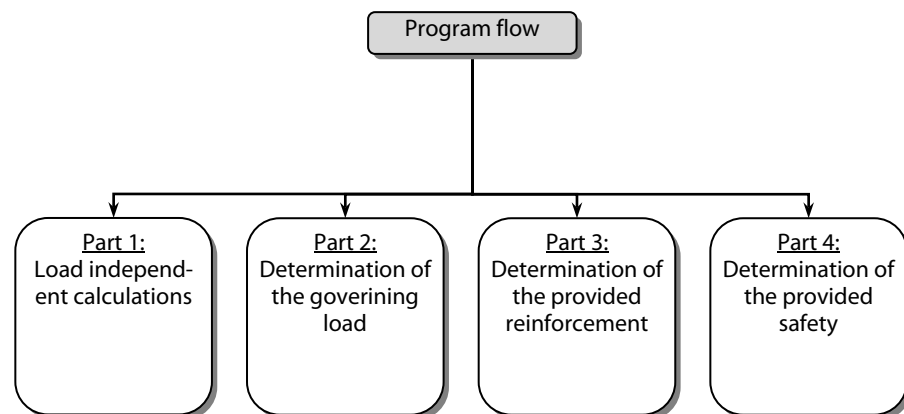


Figure 4.9: Program flow

Before we look at the individual steps, we should take a look at the definition of loading in **CONCRETE Columns**.

A loading can result from one or several single loads that are combined in load cases. For a load case, a distribution of internal forces over the column can result as shown in the following figure.

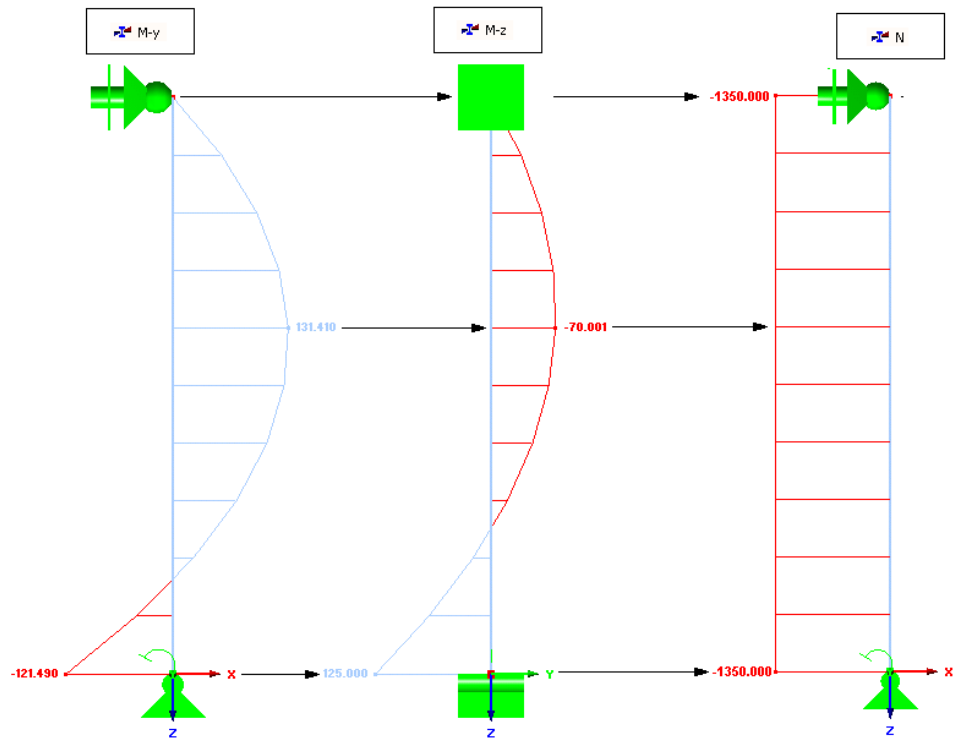


Figure 4.10: Distribution of internal forces over the column for a load case

For a rectangular column, you have only to consider, in addition to the axial force N , the two bending moments M_y , M_z whose moment vectors run parallel to the axes y or z of the member coordinate system.

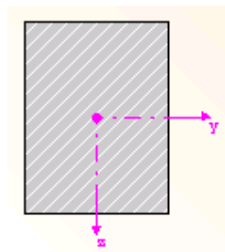


Figure 4.11: Axes of the member coordinate system

Like many studies regarding the design of compression elements confirm, the method based on nominal curvature also allows for the following simplifications:

The balance is considered only in the cross-section under the greatest loading. The deformation is determined using simplified approaches, whereby the yielding of the reinforcement is governing. This allows for the conversion of the complex design according to second order analysis into a simple cross-section design. ^[1]

This paraphrased quotation shows that the design has to be carried out for the location under the greatest load. There are five locations along a column. Only the design allows you to determine which location has the greatest load, as the greatest required reinforcement is obtained there. These five locations are:

1. Location with minimum axial force N
2. Location with maximum moment M_y
3. Location with minimum moment M_y
4. Location with maximum moment M_z
5. Location with minimum moment M_z

Here, the maximum internal force is defined as the maximum positive value. The minimum internal force is the value with a negative sign and the highest absolute value. Each of these five locations has, in addition to the extreme internal forces, corresponding internal forces that are designed subsequently.

As the distribution for the load case shows, some of these locations can concur.

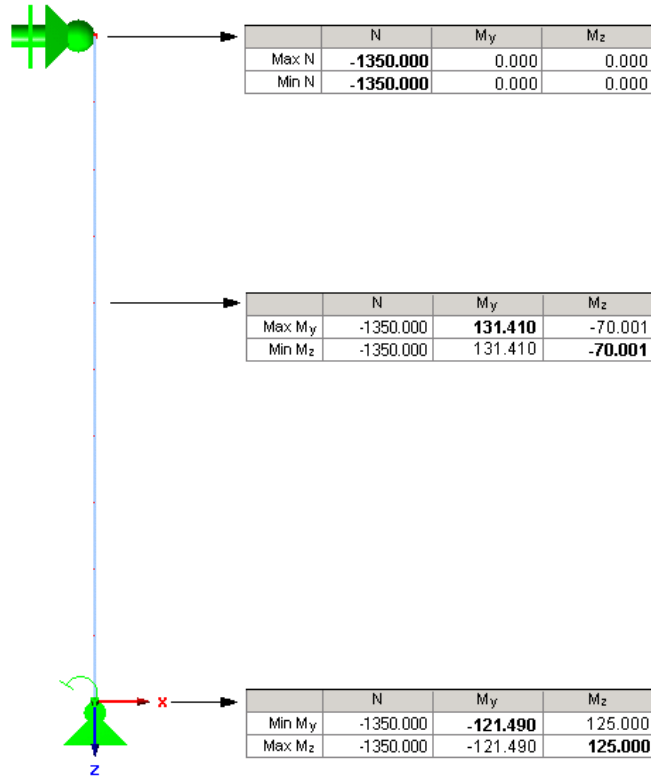


Figure 4.12: Locations with governing internal forces

No double design is carried out by the program in the case of identical internal forces,

In addition to load cases, there are load combinations and results combinations. A load combination is simply a superposition of individual load cases. Thus, only one distribution of internal forces results for each of the three internal forces N, M_y, and M_z. Therefore, what has been said about the single load case holds true for load combinations.

For result combinations, however, a maximum and minimum distribution along the column is obtained for every internal force (see the following figure).

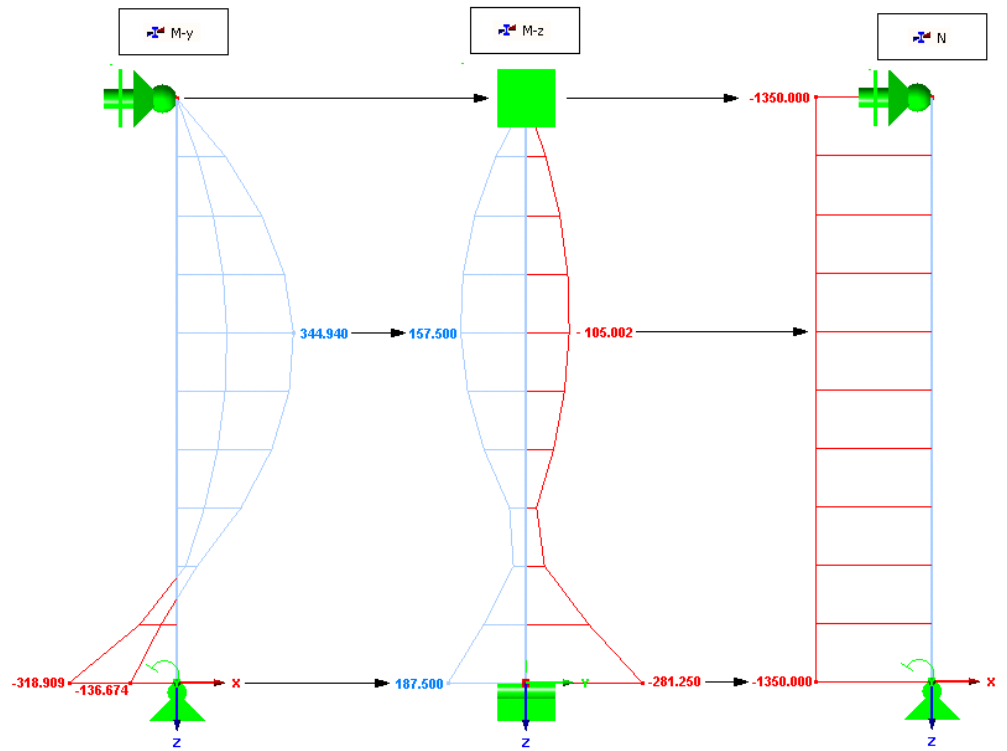


Figure 4.13: Distribution of internal forces over the column for a result combination

However, the five locations can be determined for the result combination, for which the two internal forces M_y and M_z show the maximum and minimum values and a minimum axial force N occurs.

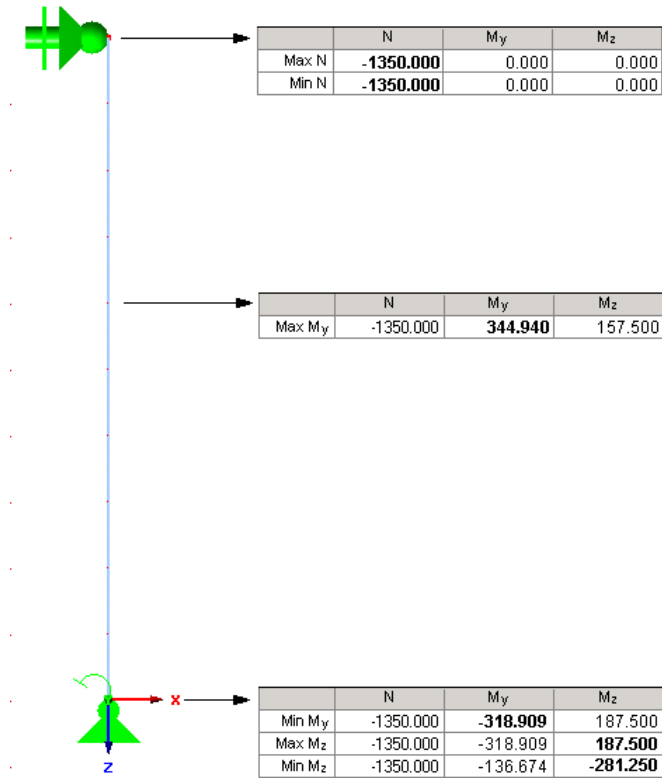


Figure 4.14: Locations with governing internal forces

In addition to the design of individual members, the design of continuous members is possible. Continuous members are connected members that do not branch out. To design continuous members, the individual members of this set of members are combined with regard to their internal forces. Then, the five locations are designed for this member. As these locations are in different members of the set of members, the maximum provided reinforcement, therefore, is to be applied along the entire set of members.

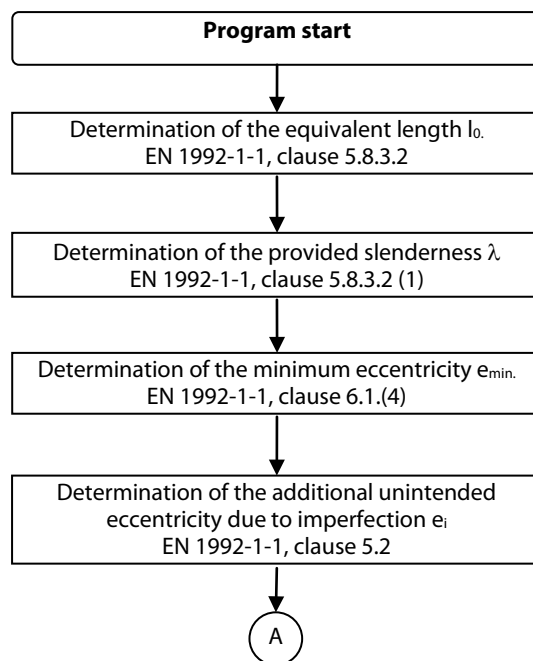
Thus it is shown that for every load case, load combination, and result combination exactly five designs have to be carried out, respectively. It does not matter whether a single member or continuous members are chosen as the element to be designed.

In which part the design is performed within the program will be shown later when the parts of the program flow are described in detail.

4.2.1 Part 1: Load Independent Calculations

These calculations are performed at the beginning of the program flow. The results can then be reused within every routine for the individual loads. The calculation steps are the following:

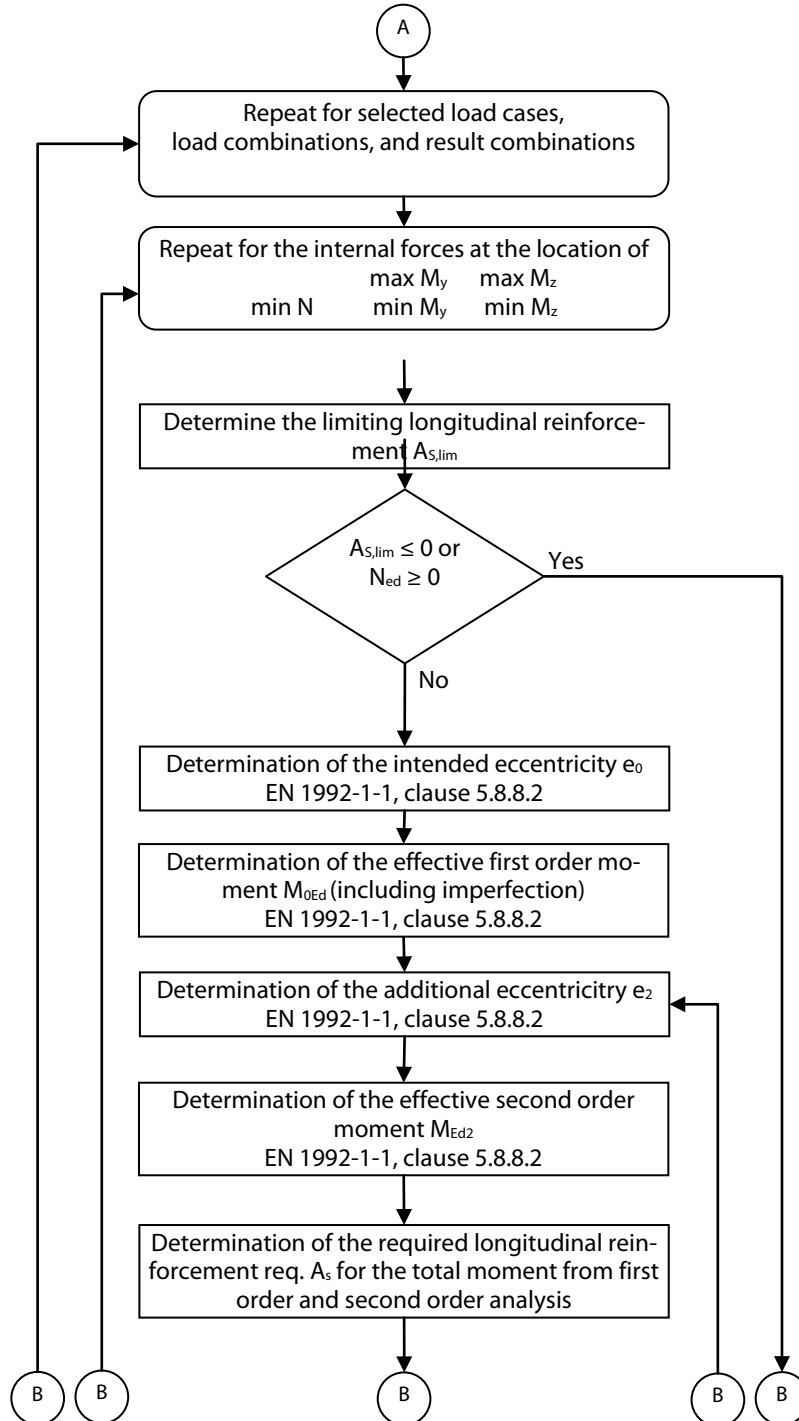
Part 1: Load independent calculation



For further information on the determination of the equivalent length, see chapter 4.1.4, on the determination of the provided slenderness, chapter 4.1.5, and on the determination of the additional unintended eccentricity due to imperfection, chapter 4.1.7 of this manual.

4.2.2 Part 2: Determination of the Governing Load

The second part of the program can be represented in a flowchart as follows:



For all design relevant locations, first the limiting slenderness λ_{lim} is determined for each of the load cases, load combinations, or result combinations to be designed. Chapter 4.1.6 describes in detail how the limiting slenderness 4.1.6 is determined. If the provided slenderness is smaller than the limiting slenderness λ_{lim} , no stability analysis is required. In the calculation process shown above, this is represented by the query $A_{S,lim} \leq 0$. ($A_{S,lim} \leq 0$ means that the limiting slen-

ness λ_{lim} calculated for a cross-section without reinforcement is greater than the provided slenderness λ . For more information, see chapter 4.1.6)

In the case of a column subjected to tension, the standard design should also be carried out instead of a stability analysis. First, these conditions are checked individually for direction y and z in the flowchart. Furthermore, the program checks if the user has excluded stability risk for this direction. The standard design is continued via the right path, whereas the continued straight path starts the stability analysis.

First, the intended eccentricity e_0 is determined depending on the distribution of internal forces as described in chapter 4.1.7.1.

Thus, both the eccentricities used to determine the first order moment (including effect from imperfection) in the next calculation step are known.

$$M_{0Ed} = N_{Ed} (e_0 + e_i)$$

where

N_{Ed} : Value of the design axial load

e_0 : Intended eccentricity according to chapter 4.1.7.1

e_i : Additional unintended eccentricity according to chapter 4.1.7.2

The program flow is continued with the determination of the additional eccentricity e_2 due to second order effects. The theoretical background was provided in chapter 0. The factor K_r , mentioned there is used to approximately calculate the curvature $1/r$. It may be given as

$$K_r = \frac{|n_u| - |n|}{|n_u| - |n_{bal}|} \leq 1$$

where n_u is the related resistance of the structural component under centric compression load. This depends on the selected reinforcement. But as no reinforcement was selected in the first loop iteration, the value of K_r is assumed to be 1.0 for the first iteration step.

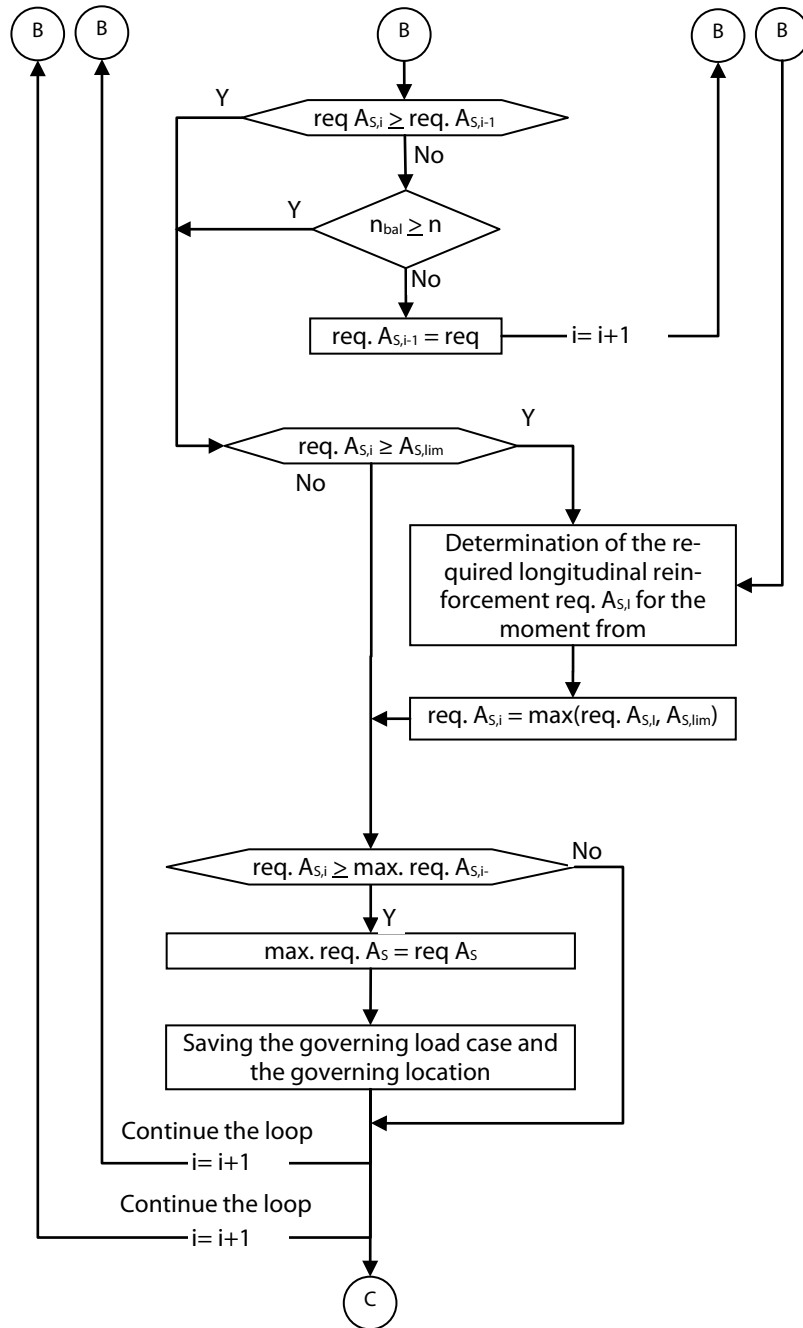
In each next loop iteration, the value n_u is determined by using the statically required reinforcement of the previous loop iteration step.

If the additional eccentricity of loading e_2 due to second order effects is known, the moment can be determined with the second order analysis.

$$M_{Ed,II} = N_{Ed} \cdot (e_0 + e_i + e_2)$$

The last step of the program flow shown above is the determination of the required reinforcement.

The next flowchart represents the lower half of the program flow part 2.



The right path also leads to the determination of the required reinforcement. It is, however, determined for first order internal forces, as a standard design was sufficient.

The middle path, however, shows which conditions must be met in order for the loop to be terminated. First, the program checks if the required reinforcement of this loop iteration is greater or equal to the required reinforcement of the previous iteration step. If the difference starts only at the fifth place after the decimal point, the reinforcements are regarded as equal. The first loop will not be terminated due to this condition, because there is no reinforcement from the previous loop.

The second condition will also come into effect only when the program tackles this location for the second time. Remember the expression used to obtain K_r . Thus it becomes clear that K_r changes only if N_{Ed} is greater than the resistant longitudinal compression force for the greatest moment resistance of the cross-section. If this is not the case, the value of K_r is always set to 1 and the second order moments would not change with every loop iteration. Therefore, these loops can be exited sooner.

If none of these two conditions was met, the required reinforcement of the current loop iteration is taken as the provided reinforcement of the next iteration step. The program is then continued via the second path from the right with the determination of the additional eccentricity of loading e_2 due to second order effects.

This loop can be exited sooner than expected only if the two aforementioned conditions were met. In order to avoid an infinite loop, however, it is automatically terminated after the 1000th run.

If the loop was terminated by one of the two conditions, the program checks if the required reinforcement of this loop iteration is greater than the limiting longitudinal reinforcement $A_{S,lim}$. If this is the case, this means that the more economical solution is to apply $A_{S,lim}$, avoiding the stability analysis. At this point, this path converges with the right path, which was used to determine the first order moments. The required reinforcement for the first order moments is obtained from the maximum value from the bending design and the limiting longitudinal reinforcement used to avoid stability analysis.

In the next step, the program checks if the required reinforcement is greater for this analyzed location and loading than the reinforcement that was the greatest up to this point for another location or load. If this is the case, the required reinforcement of this iteration step is registered as the greatest so far and the loop is continued with the next location and eventually the next load.

To illustrate this principle of finding the governing load in the second part of the flowchart, a numerical example is presented in the following table. Two selected locations are analyzed with the following internal forces as loading.

Internal Force	1	2
N [kN]:	-431,00	-1500,00
M_y [kNm]:	87,80	-72,80
M_z [kNm]:	0,00	0,00

Figure 4.15: Internal forces

For the location 1, the following steps are carried out until the loop is terminated:

Iteration	1	2
$M_{Ed,y,II}$ [kNm]:	-185,1569	-185,1569
prov. A_s [cm ²]:		13,2460
req. A_s [cm ²]:	13,2460	13,2460

Figure 4.16: Iteration – location 1

The second loop iteration is exited, because the condition $n_{bal} \geq$ is met and, therefore, the second order moments do not change.

The value 13.2460 cm² is taken as the greatest reinforcement so far. The loop is continued with the second location. Thus there will be seven steps before the loop is exited. The exit takes place because the condition that the required reinforcement is equal to the provided reinforcement of the previous loop iteration.

Iteration	1	2	3	4	5	6	7
$M_{Ed,y,II}$ [kNm]:	-465,1229	-437,8077	-436,5691	-436,5100	-436,5074	-436,5072	-436,5072
req. $A_{s,i-1}$ [cm ²]:		39,8329	36,2733	36,1117	36,1040	36,1037	36,1037
req. $A_{s,i}$ [cm ²]:	39,8329	36,2733	36,1117	36,1040	36,1037	36,1037	36,1037

Figure 4.17: Iteration – location 2

The obtained values are visualized in the following diagrams:

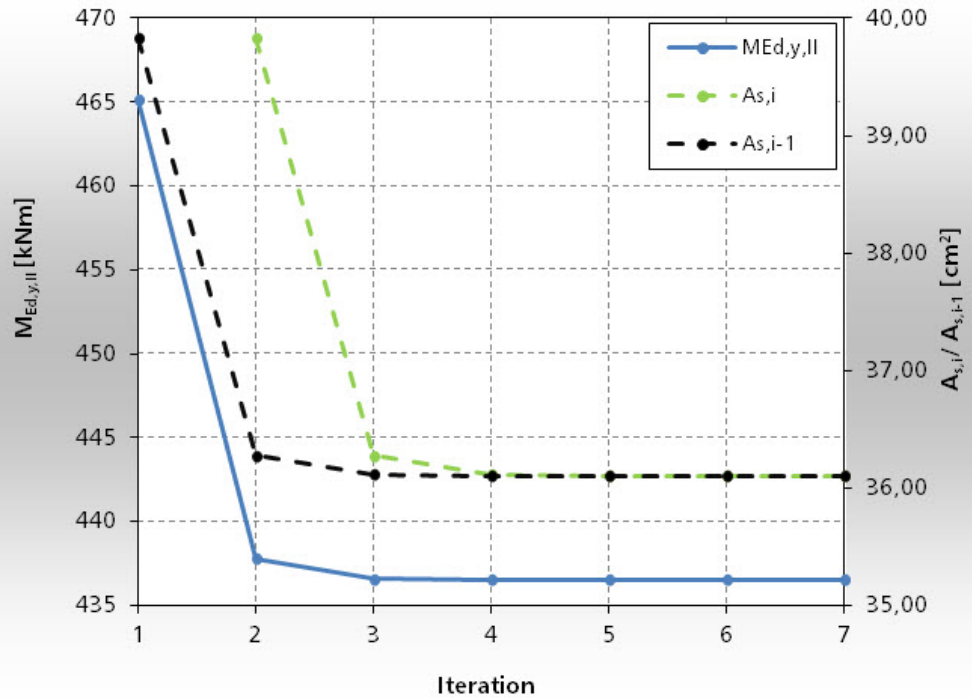
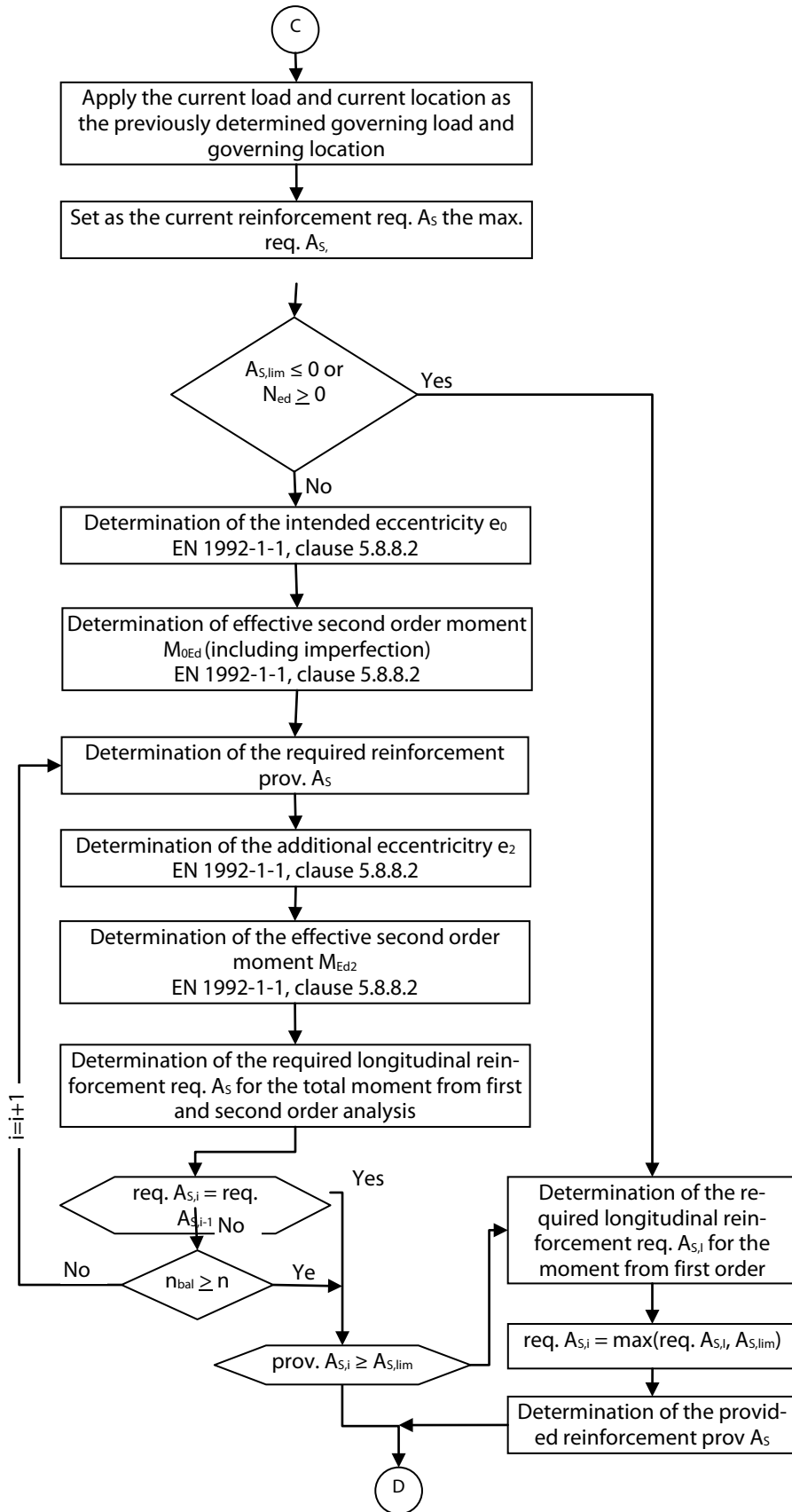


Figure 4.18: Diagram of the second order moment (vertical primary axis) as well as the required and provided reinforcement (vertical secondary axis)

The second part of the program flow concludes with the result that the governing loading results on the analyzed location 2.

In the following third part of the program flow, a reinforcement for this governing load is determined.

4.2.3 Part 3: Determination of Provided Reinforcement



The third part of the program flowchart restarts with the determination of the equivalent slendernesses. Next, the program determines whether to perform a standard design or a stability analysis.

First, the first order moment that is independent of the reinforcement, is recalculated for the stability analysis.

Then, the calculation enters a loop. In every loop iteration, the second order moments are computed with the provided reinforcement determined in the previous iteration. In the first loop iteration, the second order moments are determined independently from the reinforcement ($K_r = 1$). If a modified provided reinforcement has no influence on the magnitude of the second order moments ($n_{bal} \geq n$), the loop is exited after the second iteration. The same happens if the provided longitudinal reinforcement does not change after two loop iterations anymore.

To explain the principle of the third part of the program flow, our example is continued for the second part of the program flow. For the location 2 that is found to be governing there, the reinforcement is now to be determined. In the example, $d_s = 16, 20, 25, 26, 28,$ and 30 were selected as possible reinforcement diameters by the user.

The following amount and diameter of rebars formed the provided reinforcement of the respective iteration step:


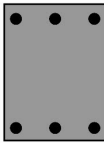

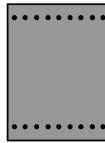
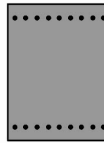
Iteration	1	2	3	4	5
					
$M_{Ed,y,II}$ [kNm]:	-465.1229	-438.6399	-436.8114	-436.5392	-436.5392
prov. A_s [cm ²]:	36.1	42.4115	36.9451	36.1911	36.1911
Number	x	6	6	18	18
ϕ [mm]:	x	30	28	16	16
req. A_s [cm ²]:	39.8329	36.3819	35.8991	34.4489	34.4489

Figure 4.19: Iteration process

Thus it is determined that the column will be reinforced with 18 members ($\phi = 16$ mm) which are to be arranged according to user specification.

This provided reinforcement yielded the following second order moments (see the following diagram).

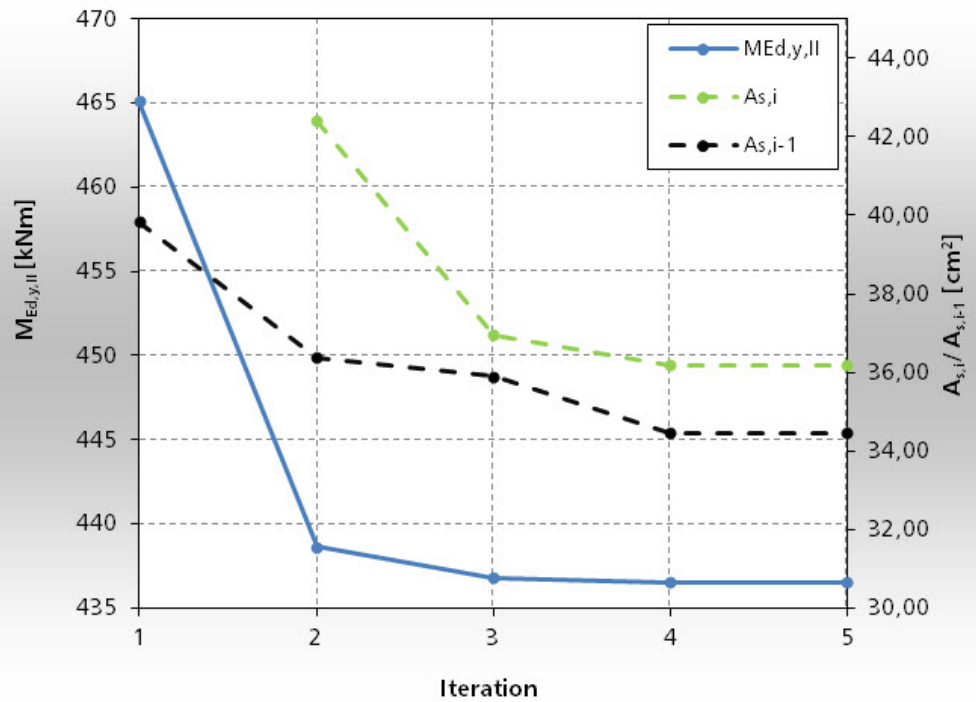


Figure 4.20: Diagram of the second order moment (vertical primary axis) as well as the distribution of the required and provided reinforcement (vertical secondary axis)

The exit criterion of the loop assumed until now that the required reinforcement results in a reduced bending moment and, therefore, a reduced provided reinforcement. The following example allows disproving this.

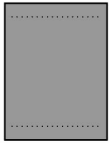
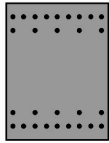
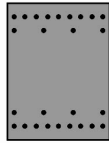


Iteration	1	2	3	4	5
					
$M_{Ed,y,II}$ [kNm]:	-465.1229	-442.3723	-441.4043	-440.8887	-440.3502
$M_{Edz,II}$ [kNm]:	96.0501	91.0648	90.8526	90.7396	90.6216
prov. A_s [cm²]:	0	56.2973	52.2761	50.2655	48.2549
Number	x	28	26	16	24
ϕ [mm]:	x	16	16	20	16
req. A_s [cm²]:	54.4809	51.0660	50.1228	47.8654	48.9917

Figure 4.21: Iteration process

The following graphic illustrates how the second order moments decrease with the decreasing provided reinforcement.

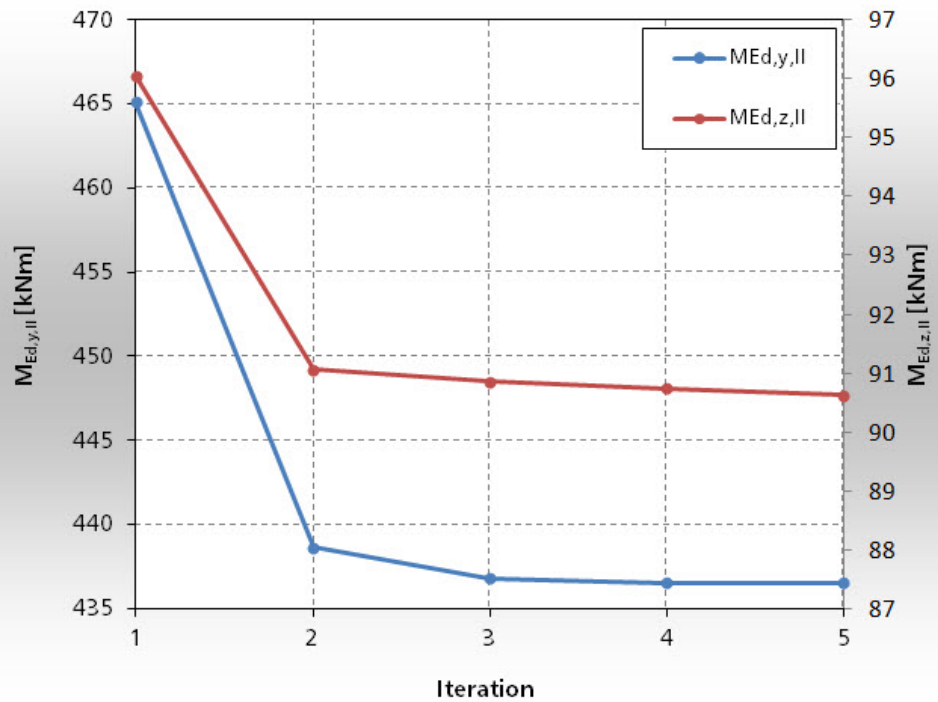


Figure 4.22: Diagram of the second order moments

Although the moments decrease, the required reinforcement of the fifth iteration step exceeds the provided reinforcement on which the required reinforcement was based.

The following graphic illustrates this:

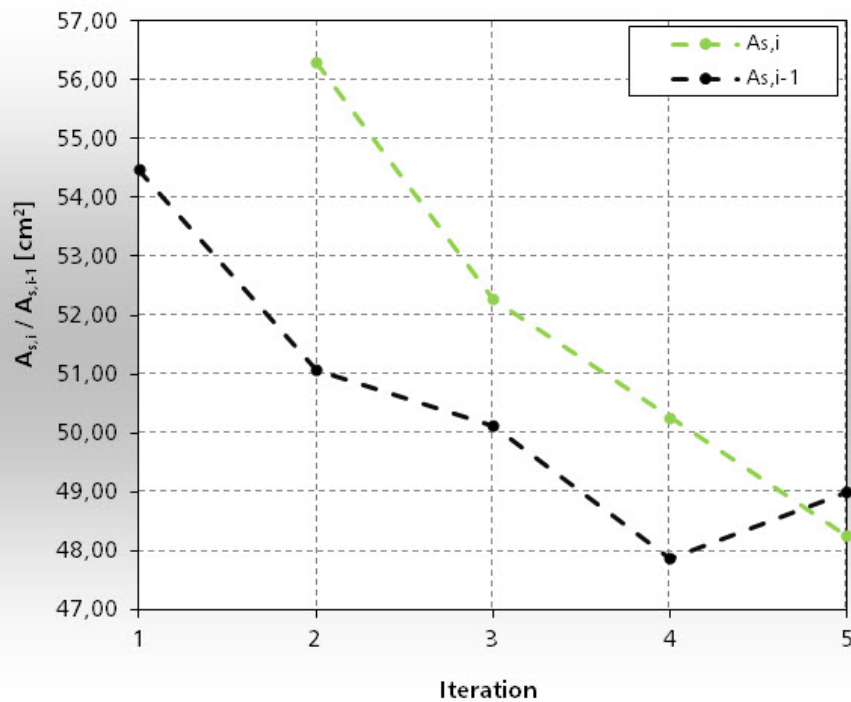


Figure 4.23: Diagram of the required and provided reinforcement

If the iterations continue, this would result in an infinite loop. This is due to the arrangement of the reinforcement. Since the provided reinforcement was arranged in two rows per side in the fifth iteration step, this results in a reduced structural height and, therefore, a greater reinforcement.

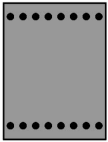
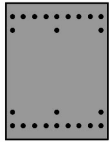
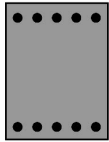
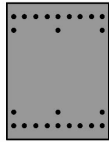
Iteration	4	5	6	7
				
$M_{Ed,y,II}$ [kNm]:	-440.8887	-440.3502	-440.5760	-440.3502
$M_{Ed,z,II}$ [kNm]:	90.7396	90.6216	90.6011	90.6216
prov. A_s [cm ²]:	47.8654	48.9917	47.9090	48.9917
Number	16	24	10	24
ϕ [mm]:	20	16	25	16
req. A_s [cm ²]:	50.2655	48.2549	49.0874	48.2549



Figure 4.24: Infinite loop

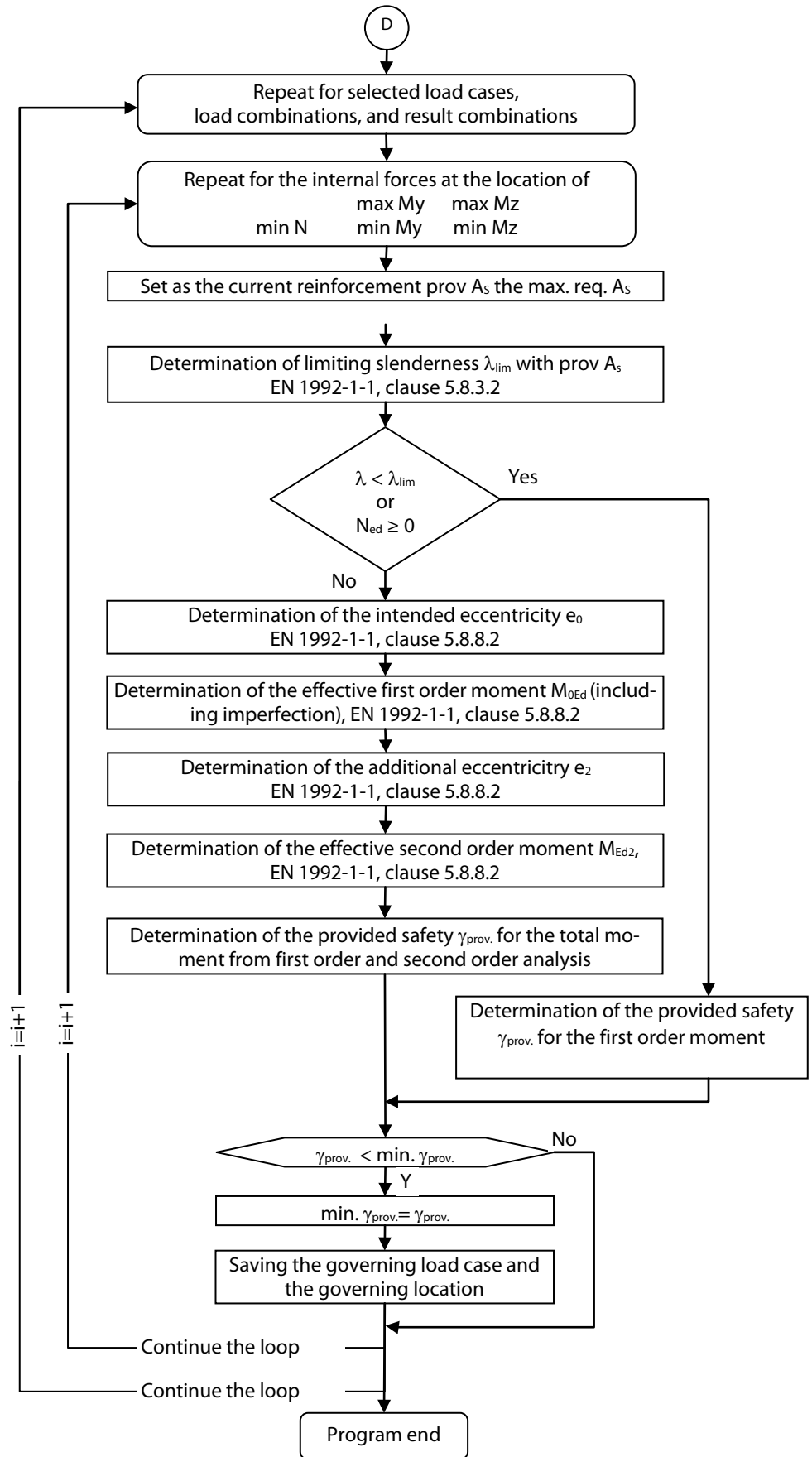
To avoid an endless loop, the iteration is calculated exactly at the point when the required reinforcement exceeds the provided reinforcement, on which it is based upon, for the first time. The provided reinforcement from the previous iteration step is used as solution. In the example above, this is the provided reinforcement from iteration step No. 4.

Thus, an automatism is created which prefers solutions with a single layer if the user has allowed several reinforcement layers by selecting the corresponding program option.

The column that is reinforced in such a way is then capable to resist load from the other load cases, load combinations, and result combinations. The resulting safety is analyzed in the fourth part of the program flow.

4.2.4 Part 4: Determining the Provided Safety

The fourth part of the program flow consists of two nested loops in order to analyze the five relevant positions for all loads.



Within the loops, there is only one branch that decides whether the safety for the moments is to be determined according to first order or second order analysis.

The following safeties have been determined for the two analyzed locations of the first example.

Location 1	Location 2
2.8028	1.0234

Figure 4.25: Safeties for location 1 and 2

4.3 Program Flow of the Check of the Provided Reinforcement

The program flow (part 1 to 4) described until this point is applied in the case that you have started the first calculation. To this end, a required reinforcement is determined in part 2 of the required reinforcement, which is independent of an actually provided reinforcement that is defined by position and rebar diameter. Not until part 3 are the various possible reinforcements tested in order to find the smallest provided reinforcement which is used in part 4 of the program flow to find the governing safety for all loads.

You will see the provided reinforcement in one of the result windows. This table allows you to modify the provided reinforcement according to your own needs. For this modified reinforcement, however, the program must redetermine the provided safety. To ensure this, the first results window displaying the provided safeties is deleted when the provided reinforcement is changed. Only the result table displaying the required reinforcement remains because it is independent of the provided reinforcement. You will see a message that informs you that the table showing the provided safety is deleted and that it is necessary to recalculate it.

Then the recalculation is started. To this end, the parts of the program flow 1 and 4 are rerun and the safety is recalculated once again.

As the program flow of the design of a longitudinal reinforcement has clearly shown, the results used for the determination of the provided safety depend first and foremost on the choice of reinforcement. Therefore, the following chapter shows how the provided reinforcement is determined from the available rebars for a required reinforcement.

4.4 Determination of the Required Reinforcement

If the required reinforcement has been determined, you have to select from the previously selected rebars the number of a certain rebar diameter with

$$\text{prov. } A_s \geq \text{req. } A_s$$

At the same time, you have to take into account that the provided reinforcement does not fall below the minimum reinforcement or exceeds the maximum reinforcement, as prescribed according to EN 1992-1-1: 2010 clause 9.6.2:

$$A_{s,\min} = 0.10 \cdot \frac{N_{Ed}}{f_{yd}} \geq 0.002 \cdot A_c$$

$$A_{s,\max} = 0.04 \cdot A_c, \text{ as well as in the case of overlap } A_{s,\max} = 0.08 \cdot A_c$$

This reinforcement is to be designed for the resistance of moments from unintended restraint. However, the cross-section of the reinforcement may not fall below a minimum value. There is also a regulation regarding the minimum number of rebars. For columns with circular cross-

sections, you have to place at least four reinforcement members. For columns with rectangular cross-sections, a rebar must be placed in every corner (9.5.2 (4)).

The program follows the recommendation from [1] to reinforce compression elements only symmetrically. The following reasons support this:

- An unsymmetrical reinforcement is often no more economical than a symmetrical one because the moments at the column head and footing have a varying sign and mostly have the same magnitude.
- The possibility must be excluded that it is placed wrongly, that is rotated by 180° (this can occur in the case of unsymmetrical reinforcement).

Under the latter assumptions, the number and diameter of the rebars can be determined.

4.4.1 Rectangular Cross-Section

The number of rebars significantly depends on the arrangement of rebars that you have selected. You can select from the following arrangement for a rectangular cross-section:

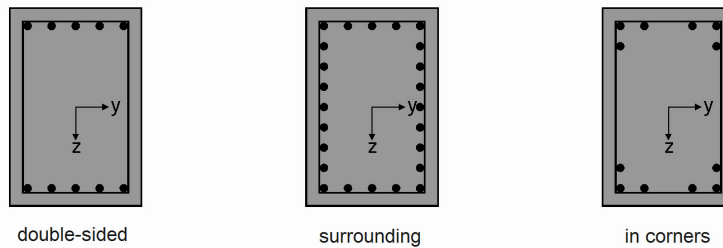


Figure 4.26: Arrangement of the reinforcement

In the case of a double-sided reinforcement, you can decide whether to arrange the reinforcement parallel to the y -axis or parallel to the z -axis of the cross-section coordinate system.

You can also specify the minimum spacing a_{\min} of the rebars within the first layer. In the first layer, the provided distances a may not be smaller than this minimum distance a_{\min} .

You can also define the minimum distance b_{\min} within the minimum layer. For a double-sided reinforcement, the spacing b may not be smaller the minimum spacing b_{\min} .

You can also specify the minimum distance e_{\min} to the second layer. The distance e for double-sided reinforcement may not be smaller than the minimum spacing e_{\min} .

The arrangement of a second reinforcement layer is possible only for double-sided reinforcement layout.

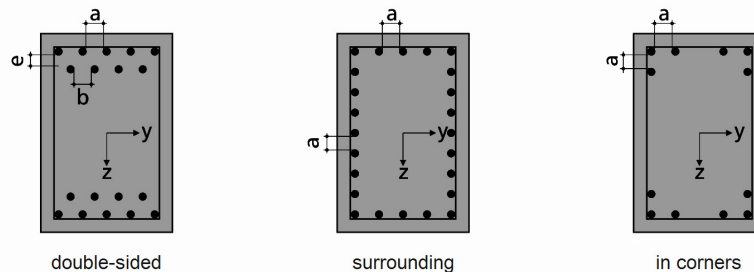


Figure 4.27: Distance a , b , and e of the rebars

The layer of the first four rebars depends on the defined concrete cover. The program offers you two options to specify the concrete cover:

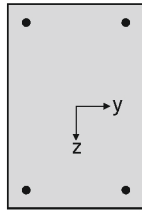


Figure 4.28: Layer of the first four rebars.

As a centroidal axis cover (left figure) and as an edge cover (right figure).

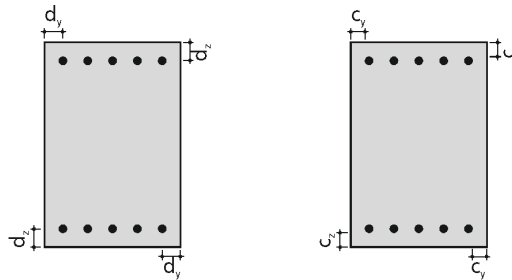


Figure 4.29: Type and size of concrete cover

When the type and the size of the concrete cover is obtained, the remaining area R_y and R_z or R_{y2} (in the case of a double-layered reinforcement layer), in which rebars can be inserted, can be determined.

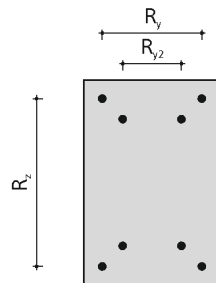


Figure 4.30: Area for further rebars in the case of single-layered or double-layered reinforcement layout

Once the areas are obtained, in the routine the rebars are inserted beginning with the smallest user-defined rebar diameter. The following three events can result in the routine's termination.

Event 1: The provided reinforcement cross-section **prov A_s** is greater than the required reinforcement cross-section **req A_s** . The rebar diameter and the amount of rebars are saved as solution.

Event 2: No more rebars can be placed within the first reinforcement layer, as the bar distance a would be smaller than the minimum bar diameter a_{\min} . If you specified that only one reinforcement layout is allowed, the routine is unsuccessfully terminated.

Event 3: Furthermore, no more rebars can be placed within the second reinforcement layer, as the bar distance b would fall below the minimum b_{\min} . The routine is unsuccessfully stopped.

If the routine is terminated, the program continues with the rebar diameter that has the next larger diameter. If all bar diameters provided by the user have been run through, the saved solutions are compared with each other. The solution that results in the smallest difference between the provided reinforcement and the required reinforcement is selected as solution. The program next checks if the allowable reinforcement ratios are kept.

4.4.2 Circular cross-section

In the case of circular cross-sections, rebars are arranged radially to the center of cross-section. Their minimum number is four.

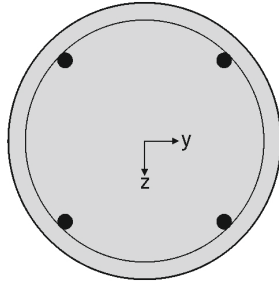


Figure 4.31: Layout of the reinforcement

You have to specify the minimum distance a_{\min} of the rebars. The provided clear spacing a may not be smaller than the minimum spacing a_{\min} .

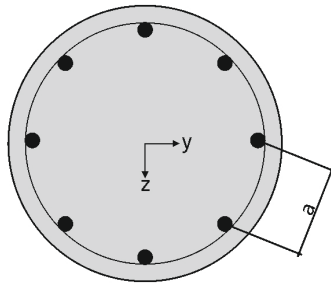


Figure 4.32: Spacing a of the rebars

When circular cross-sections are used, the program does not show reinforcement proposals with a double-layered reinforcement, because in practice this is only possible with an disproportionately great layout work.

The position of the rebars is determined by the concrete cover. As described in chapter 4.4.1 *Rectangular Cross-Section*, you can either use the centroidal axis or the edge cover to define the concrete cover.

If type and size of the concrete cover is obtained and the bar diameter is selected, you can determine the inscribed circle on which the centroids of the rebars lie.

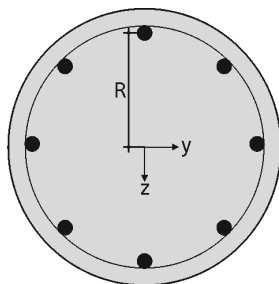


Figure 4.33: Circle with centroids of rebars

This circle has the radius R and the perimeter P .

We next determine the required number n of rebars.

$$n = \frac{\text{req. } A_s}{A_{s,\text{Member}}}$$

The obtained value is rounded to an integer. With the known perimeter P , we now can determine the intermediate angle α .

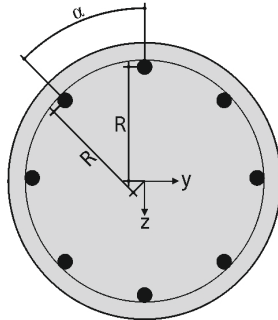


Figure 4.34: Intermediate angle α

This is done by using the following expression:

$$\alpha = \frac{360^\circ}{n}$$

In this way, the clear spacing a of the rebars can be determined.

$$a = 2 \cdot R \cdot \sin\left(\frac{\alpha}{2}\right) - d_s$$

If this clear spacing is smaller than the minimum allowable spacing, the solution with this rebar diameter is discarded and the process is repeated with the next greater bar diameter. If, however, the spacing is greater, the obtained solution is saved.

If all provided rebar diameters have been run through, the different solutions are compared with each other. Then the solution in which the provided reinforcement comes closest to the required reinforcement is selected.

4.5 Fire Resistance Design

The fire resistance design with CONCRETE Columns is performed according to the simplified method of calculation according to EN 1992-1-2, 4.2 [3]. The program uses the *zone method* described in Annex B.2:

In case of exposure to fire, the bearing capacity is reduced due to a reduction of the component's cross-section and a decrease of the material stiffnesses. The damaged concrete zones directly exposed to fire are not taken into account for the equivalent cross-section that is used for the fire resistance design. The fire resistance design is performed with the reduced cross-section and the reduced material properties similar to the ultimate limit state design at normal temperature.

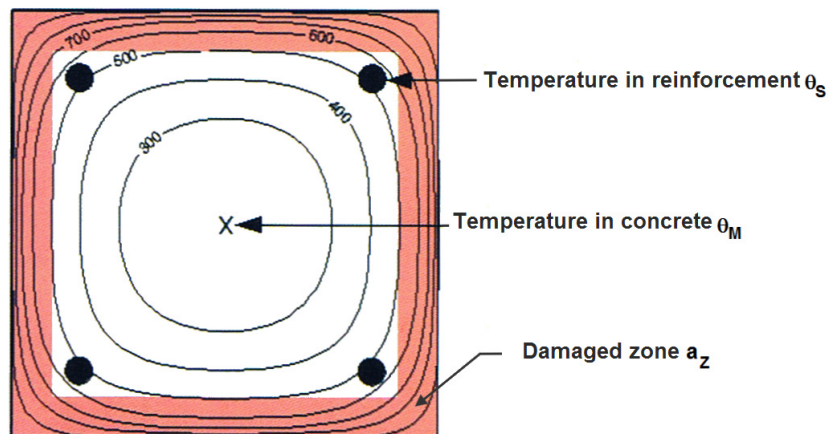


Figure 4.35: Cross-section exposed to fire with damaged zones

4.5.1 Subdivision of Cross-Section

The cross-section is subdivided into a certain number of parallel ($n \geq 3$) zones having the same thickness. For each zone, the program determines the mean temperature, the corresponding compressive strength $f_{c,\theta}$, and, if necessary, the modulus of elasticity.

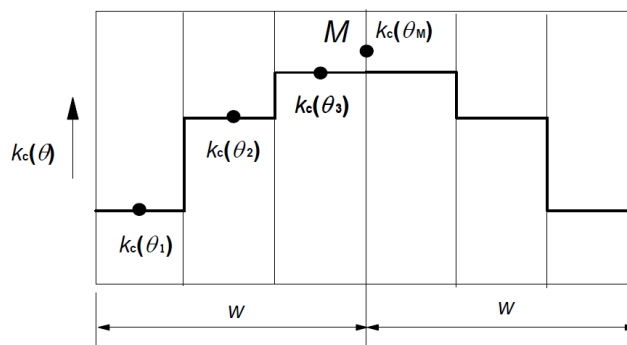


Figure 4.36: Subdivision of a wall with both sides exposed to fire into zones according to [3], Figure B.4.

The cross-section exposed to fire is compared with an equivalent wall. The width of the equivalent wall is $2 \cdot w$. As shown in Figure 4.36, the equivalent width is to be subdivided symmetrically in several zones.

Half of the equivalent width w depends on the fire load acting on the structural component. The following table gives an overview of the determination of equivalent widths conforming to standards:

Fire load	Half of equivalent width w
Component with one side exposed to fire	Width of component in direction of fire effects
Column or wall with both sides (facing each other) exposed to fire	$0.5 \cdot$ Width of component in direction of fire effects
Column with four sides exposed to fire	$0.5 \cdot$ smallest external cross-section dimension

Figure 4.37: Determination of equivalent widths

4.5.2 Reduction of Cross-Section

Determination of temperature θ_i in center of zone

Upon to the cross-section's subdivision into zones, the temperature θ is determined in the center of each zone i . The determination is facilitated by temperature courses in accordance with EN 1992-1-2, Annex A, based on the following assumptions:

- The concrete's specific heat corresponds with the specifications according to EN 1992-1-2, 3.2.2.
- The moisture is 1.5 % (for moistures > 1.5 %, the specified temperatures are on the safe side).
- The concrete's thermal conductivity is the lower limit value mentioned in EN 1992-1-2, 3.3.3.
- The emission value for the concrete surface is 0.7.
- The convective heat-transmission coefficient is $25 \text{ W/m}^2\text{K}$.

Determination of reduction factor $k_c(\theta_i)$

The reduction factor $k_c(\theta_i)$ is specified for the temperature determined in the center of the zone i to account for the decrease of the characteristic concrete compressive strength f_{ck} . The reduction factor $k_c(\theta_i)$ depends on the concrete's aggregates.

According to EN 1992-1-2, Figure 4.1, graph 1 shown in the diagram below is to be used for normal concrete with aggregates containing quartz. Graph 2 represents normal concrete with aggregates containing limestone.

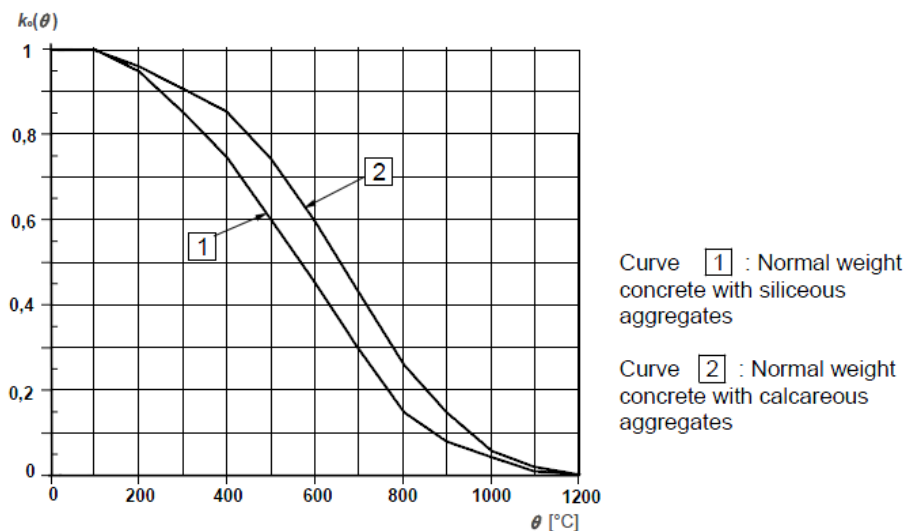


Figure 4.38: Factor $k_c(\theta_i)$ used to consider decrease of concrete compressive strength according to [3], Figure 4.1

Determination of damaged zone with thickness a_z

The cross-section damaged by fire is represented by a reduced cross-section. This means that a damaged zone of the thickness a_z on the sides exposed to fire is not taken into account for the ultimate limit state design.

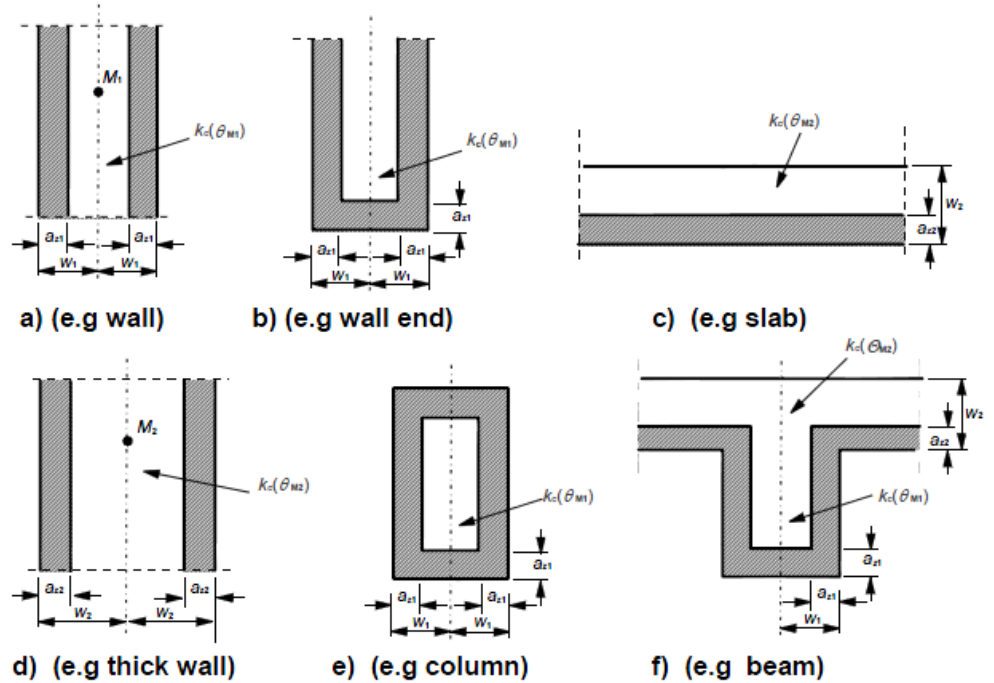


Figure 4.39: Reduction of strength and cross-section in case of fire according to [3], Figure B.3.

The calculation of the damaged zone thickness a_z depends on the component type:

- **Beams, slabs**

$$a_z = w \cdot \left[1 - \frac{k_{c,m}}{k_c(\theta_M)} \right]$$

- **Columns, walls, and other structural components for which effects due to second-order analysis must be taken into account**

$$a_z = w \cdot \left[1 - \left(\frac{k_{c,m}}{k_c(\theta_M)} \right)^{1,3} \right]$$

where

w Half of width of equivalent wall

$k_{c,m}$ Mean reduction coefficient for a specific cross-section

$$k_{c,m} = \frac{(1 - 0,2/n)}{n} \sum_{i=1}^n k_c(\theta_i)$$

n Number of parallel zones in w

The change of temperature in each zone is taken into account by means of the factor $(1 - 0.2/n)$.

$k_c(\theta_M)$ Reduction coefficient for concrete at point M (see Figure 4.38 on page 39)

4.5.3 Stress-Strain Curve of Concrete

Point M is governing for the reduction of the concrete's material properties. M is a point on the central line of the equivalent wall (see Figure 4.36, page 38). It is used to determine the reduction factor $k_c(\theta_M)$. The reduced material properties of the concrete are to be used for the entire reduced cross-section (without the damaged zone a_z) in the ultimate limit state design in case of fire.

Concrete compressive strength for fire resistance design

The stress-strain curve for the concrete compressive strength is determined depending on the temperature in point M as well as depending on the type of aggregates. The values of the compression strain $\epsilon_{cu1,\theta}$ for the compression strength $f_{c,\theta}$ can be found in EN 1992-1-2, Table 3.1.

$$f_{c,\theta} = k_c(\theta_M) \cdot f_{ck}$$

where

- $k_c(\theta_M)$ Reduction coefficient for concrete at point M (see Figure 4.38, page 39)
- f_{ck} characteristic concrete compressive strength for normal temperature

Concrete temp. θ [°C]	Siliceous aggregates			Calcareous aggregates		
	$f_{c,\theta} / f_{ck}$ [-]	$\epsilon_{c1,\theta}$ [-]	$\epsilon_{cu1,\theta}$ [-]	$f_{c,\theta} / f_{ck}$ [-]	$\epsilon_{c1,\theta}$ [-]	$\epsilon_{cu1,\theta}$ [-]
1	2	3	4	5	6	7
20	1,00	0,0025	0,0200	1,00	0,0025	0,0200
100	1,00	0,0040	0,0225	1,00	0,0040	0,0225
200	0,95	0,0055	0,0250	0,97	0,0055	0,0250
300	0,85	0,0070	0,0275	0,91	0,0070	0,0275
400	0,75	0,0100	0,0300	0,85	0,0100	0,0300
500	0,60	0,0150	0,0325	0,74	0,0150	0,0325
600	0,45	0,0250	0,0350	0,60	0,0250	0,0350
700	0,30	0,0250	0,0375	0,43	0,0250	0,0375
800	0,15	0,0250	0,0400	0,27	0,0250	0,0400
900	0,08	0,0250	0,0425	0,15	0,0250	0,0425
1000	0,04	0,0250	0,0450	0,06	0,0250	0,0450
1100	0,01	0,0250	0,0475	0,02	0,0250	0,0475
1200	0,00	-	-	0,00	-	-

Figure 4.40: Parameters of stress-strain relation for concrete in case of fire according to [3], Table 3.1

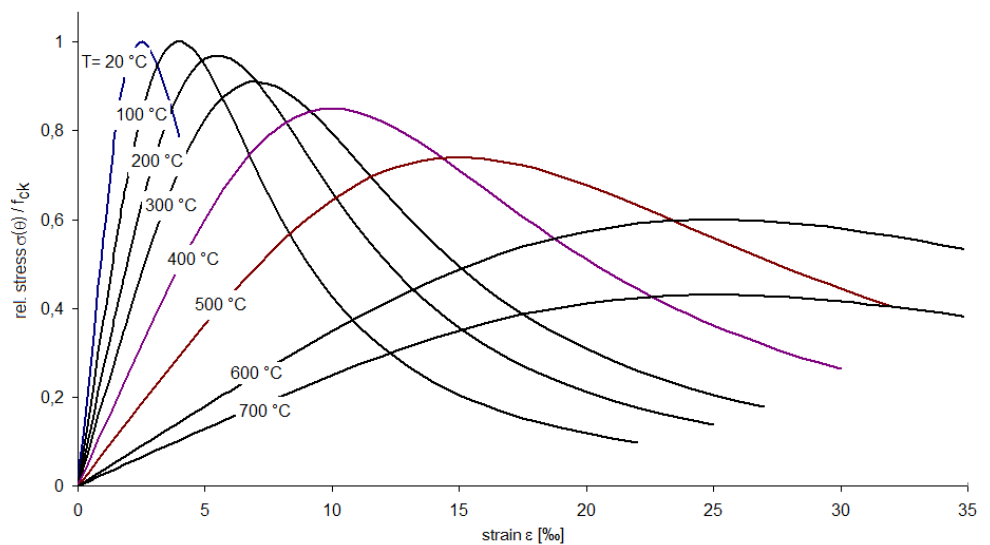


Figure 4.41: Stress-strain diagram for concrete with aggregates containing limestone, depending on temperature

As you can see in the diagram (Figure 4.40), the stress-strain relation of normal concrete with aggregates containing limestone is changing depending on the temperature. The decreasing graph is not taken into account for the fire protection design.

The concrete's reduced modulus of elasticity is determined for the fire protection design according to the following equation:

$$E_{cd,\theta} = [k_c(\theta_M)]^2 \cdot E_c$$

where

$k_c(\theta_M)$ Reduction coefficient for concrete at point M (see Figure 4.38, page 39)

E_c Elastic modulus of concrete for normal temperature (20 °C)

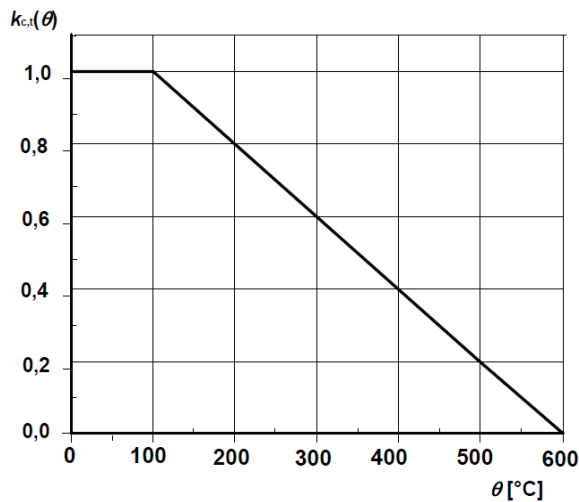
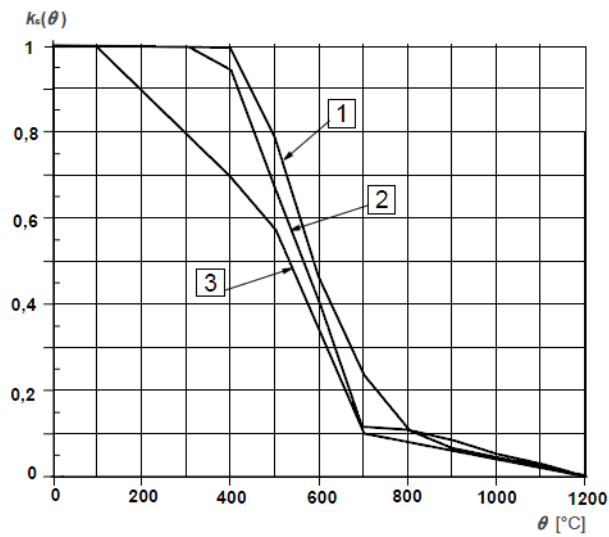


Figure 4.42: Reduction factor $k_{c,t}(\theta)$ to consider temperature-dependent tensile strength of concrete f_{ct} according to [3], Figure 3.2

4.5.4 Stress-Strain Curve of Reinforcing Steel

Determination of reduction factor $k_s(\theta)$ for tensile strength of steel

To determine the reduction factor $k_s(\theta)$, the temperature in the center of the most unfavorable reinforcing member must be determined first. Depending on how the reinforcing steel is produced and classified (Class N or X) and how much it is strained, the reduction factor $k_s(\theta)$ is defined (see the following figure).

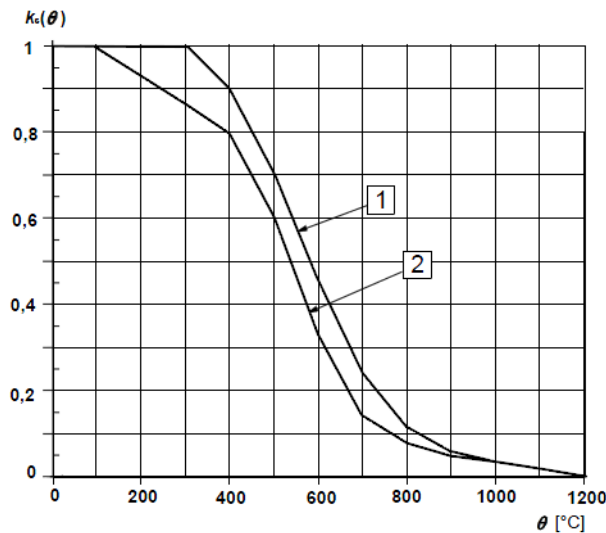


Curve **1** : Tension reinforcement (hot rolled) for strains $\epsilon_{s,fi} \geq 2\%$

Curve **2** : Tension reinforcement (cold worked) for strains $\epsilon_{s,fi} \geq 2\%$

Curve **3** : Compression reinforcement and tension reinforcement for strains $\epsilon_{s,fi} < 2\%$

Class N



Curve **1** : Tension reinforcement (hot rolled and cold worked) for strains $\epsilon_{s,fi} \geq 2\%$

Curve **2** : Compression reinforcement and tension reinforcement (hot rolled and cold worked) for strains $\epsilon_{s,fi} < 2\%$

Class X

Figure 4.43: Reduction factor $k_s(\theta)$ for taking account of temperature-dependent tensile strength of steel according to [3], Figure 4.2a/b

Reduction of reinforcing steel strength $f_{sy,\theta}$

The stress-strain relation of the reinforcing steel is defined by the following three parameters:

- Slope in linear-elastic range $E_{s,\theta}$
- Proportional limit $f_{sp,\theta}$
- Maximum stress level $f_{sy,\theta}$

The maximum strength of the reinforcing steel that is to be applied for the fire resistance design is determined as follows:

$$f_{sy,\theta} = k_s(\theta) \cdot f_{yk}$$

where

- $k_s(\theta)$ Reduction coefficient for reinforcing steel (see Figure 4.43)
- f_{yk} characteristic strength of reinforcing steel for normal temperature

Determination of reduced elastic modulus $E_{s,\theta}$ of reinforcing steel

If the reinforcing steel can be assigned to graph 1 or graph 2 of Figure 4.2a or 4.2b shown in EN 1992-1-2 (see Figure 4.43), it is possible to take the reinforcing steel's reduced elastic modulus, depending on the steel temperature and type of production, from EN 1992-1-2, Table 3.2a or 3.2b.

Steel Temperature θ [°C]	$f_{sy,\theta} / f_{yk}$		$f_{sp,\theta} / f_{yk}$		$E_{s,\theta} / E_s$	
	hot rolled	cold worked	hot rolled	cold worked	hot rolled	cold worked
1	2	3	4	5	6	7
20	1,00	1,00	1,00	1,00	1,00	1,00
100	1,00	1,00	1,00	0,96	1,00	1,00
200	1,00	1,00	0,81	0,92	0,90	0,87
300	1,00	1,00	0,61	0,81	0,80	0,72
400	1,00	0,94	0,42	0,63	0,70	0,56
500	0,78	0,67	0,36	0,44	0,60	0,40
600	0,47	0,40	0,18	0,26	0,31	0,24
700	0,23	0,12	0,07	0,08	0,13	0,08
800	0,11	0,11	0,05	0,06	0,09	0,06
900	0,06	0,08	0,04	0,05	0,07	0,05
1000	0,04	0,05	0,02	0,03	0,04	0,03
1100	0,02	0,03	0,01	0,02	0,02	0,02
1200	0,00	0,00	0,00	0,00	0,00	0,00

Class N

Steel Temperature θ [°C]	$f_{sy,\theta} / f_{yk}$	$f_{sp,\theta} / f_{yk}$	$E_{s,\theta} / E_s$
	hot rolled and cold worked	hot rolled and cold worked	hot rolled and cold worked
20	1,00	1,00	1,00
100	1,00	1,00	1,00
200	1,00	0,87	0,95
300	1,00	0,74	0,90
400	0,90	0,70	0,75
500	0,70	0,51	0,60
600	0,47	0,18	0,31
700	0,23	0,07	0,13
800	0,11	0,05	0,09
900	0,06	0,04	0,07
1000	0,04	0,02	0,04
1100	0,02	0,01	0,02

Class X

Figure 4.44: Parameters of stress-strain relation for steel in case of fire according to [3], Table 3.2a/b

For reinforcing steels that are assigned to graph 3 according to EN 1992-1-2, Figure 4.2a, the reduced modulus of elasticity is calculated as follows:

$$E_{s,\theta} = k_s(\theta) \cdot E_s$$

where

$k_s(\theta)$ Reduction coefficient for reinforcing steel (see Figure 4.43)

E_s Elastic modulus of reinforcing steel for normal temperature (20 °C)

4.6 Check of Shear Force

4.6.1 Design Method

The design of shear force resistance is only performed in the ultimate limit state (ULS). The actions and resistances are considered with their design values. The general design requirement is the following:

$$V_{Ed} \leq V_{Rd}$$

where

V_{Ed} : Design value of applied shear force

V_{Rd} : Design value of shear force resistance

Depending on the failure mechanism, the design value of the shear force resistance is determined by one of the following three values:

$V_{Rd,c}$: Design shear resistance of a structural component without shear reinforcement

$V_{Rd,s}$: Design shear resistance of a structural component with shear reinforcement, limited by yield strength of shear reinforcement (failure of tie)

$V_{Rd,max}$: Design shear resistance that is limited by strength of concrete compression strut

If the applied shear force V_{Ed} remains below the value of $V_{Rd,c}$, no shear reinforcement is mathematically required and the design is fulfilled.

$$V_{Ed} \leq V_{Rd,c}$$

If the applied shear force V_{Ed} is higher than the value of $V_{Rd,c}$, a shear reinforcement must be designed. The shear reinforcement must absorb the entire shear force. In addition, the capacity of the concrete compression strut must be analyzed.

$$V_{Ed} \leq V_{Rd,s}$$

$$V_{Ed} \leq V_{Rd,max}$$

We next present the different expressions used to determine the different types of shear force resistance.

4.6.2 Design Shear Resistance Without Shear Reinforcement

The design shear resistance without shear reinforcement is determined according to EN 1992-1-1:2010 Expression 6.2a or 6.2b.

$$V_{Rd,c} = \left[C_{Rd,c} \cdot k \cdot (100 \cdot \rho_l \cdot f_{ck})^{\frac{1}{3}} + k_1 \cdot \sigma_{cp} \right] \cdot b_w \cdot d \quad 6.2a$$

with a minimum value

$$V_{Rd,c} = [v_{min} + k_1 \cdot \sigma_{cp}] \cdot b_w \cdot d \quad 6.2b$$

where

$$C_{Rd,c} = \frac{0.18}{\gamma_c}$$

k : Factor for taking account of slab depth, size effect:

$$k = 1 + \sqrt{\frac{200}{d}} \leq 2.0 \quad d \text{ [mm]}$$

d : Effective depth of bending reinforcement in [mm]

ρ_l : Ratio of longitudinal reinforcement

$$\rho_l = \frac{A_{sl}}{b_w \cdot d} \leq 0.02$$

where A_{sl} : Area for tension reinforcement extended by minimum $(l_{bd} + d)$ beyond corresponding cross-section

b_w : Minimum width of cross-section within tension zone in [mm]

f_{ck} : Characteristic value of concrete compressive strength in $[N/mm^2]$

$$k_1 = 0.15$$

$$\sigma_{cp} = \frac{N_{Ed}}{A_c} < 0.2 \cdot f_{cd} \quad \text{in } [N/mm^2]$$

where N_{Ed} : axial force in cross-section due to loading or prestress [N]
($N_{Ed} > 0$ for compression). The influence of restraint on N_{Ed} may be neglected;

A_c : Concrete cross-section in $[mm^2]$

$$v_{min} = 0.035 \cdot k^{\frac{3}{2}} \cdot f_{ck}^{\frac{1}{2}}$$

$V_{Rd,c}$ in [N]

The Equation (6.2) is only valid if the concrete cross-section is not fully compressed or fully cracked.

In the case of a fully cracked cross-section, the value of the design shear resistance $V_{Rd,c}$ is negative. In addition to that, the program checks if there is a location of the concrete cross-section in compression. If there is no location (that is, in the case of a fully cracked cross-section) or one location and the design shear resistance $V_{Rd,c}$ without shear reinforcement is nonetheless negative, an error message regarding failed design appears and the design is stopped.

In the case of a fully compressed cross-section, there will be a positive value for the design shear resistance $V_{Rd,c}$. However, the preconditions for the empirical equation are not met. In clause 6.2.2 of EN 1992-1-1:2010, Expression (6.4) for unreinforced concrete is given:

$$V_{Rd,c} = \frac{l \cdot b_w}{S} \cdot \sqrt{\left(\frac{f_{ctk;0.05}}{\gamma_c}\right)^2 - \alpha_l \cdot \sigma_{cp}} \cdot \frac{f_{ctk;0.05}}{\gamma_c} \quad 6.4$$

Thus, the code gives an expression that is independent of the cross-section of reinforcement in tension and thus allows for a design of fully compressed cross-sections.

The expression may not be applied if the tension stresses of concrete are smaller than $f_{ctk;0.05} / \gamma_c$. To verify the precondition, the definition points of the concrete cross-section are analyzed. If none of these points has a tensile force, the Expressions (6.2a) or (6.2b) are used.

4.6.3 Design Shear Resistance with Shear Reinforcement

The design shear resistance of the shear reinforcement (tie) is obtained according to 1992-1-1:2010 Expression 6.8, 6.9.

Structural components with a shear reinforcement angle of 90°:

$$V_{Rd,s} = (A_{sw} / s) \cdot z \cdot f_{ywd} \cdot \cot \theta \quad 6.8$$

or inclined shear reinforcement:

$$V_{Rd,s} = (A_{sw} / s) \cdot z \cdot f_{ywd} \cdot (\cot \theta + \cot \alpha) \cdot \sin \alpha \quad 6.13$$

where

- A_{sw} : Cross-sectional area of shear reinforcement
- s : Distance between links
- z : Lever of internal forces
- f_{ywd} : Design value for yield strength of shear reinforcement
- θ : Angle between concrete compressive strut and the structural component a_x is perpendicular to the shear force
- α : Angle between the shear reinforcement and the structural component axis perpendicular to the shear force

The inclination of the concrete compression strut may be selected within certain limits depending on the loading (see Equation 6.7). In this way, the equation can take into account the fact that a part of the shear force is absorbed by crack friction. Thus, the structural system is less stressed.

$$1.0 \leq \cot \theta \leq 2.5 \quad 6.7$$

The German National Annex DIN EN 1992-1-1/NA:2011-01 specifies the inclination of the concrete compression strut as follows:

$$1.0 \leq \cot \theta \leq \frac{1.2 + 1.4 \cdot \frac{\sigma_{cd}}{f_{cd}}}{1 - \frac{V_{Rd,cc}}{V_{Ed}}} \leq 3.0 \quad 6.7aDE$$

In the case of inclined shear reinforcement, $\cot \theta$ may be utilized up to 0.58.

where

$$V_{Rd,cc} = c \cdot 0.48 \cdot f_{ck}^{\frac{1}{3}} \cdot \left(1 - 1.2 \cdot \frac{\sigma_{cd}}{f_{ck}} \right) \cdot b_w \cdot z \quad 6.7bDE$$

σ_{cd} : Design value of concrete longitudinal stress at the level of the cross-section's centroid

$$c = 0.5$$

The inclination of the concrete strut θ can vary according to EN1992-1-1:2010 between the following values:

	Minimum inclination	Maximum inclination
θ	21.80°	45.00°
$\cot \theta$	2.50	1.00

Figure 4.45: Inclination of concrete strut θ

A flatter concrete compression strut results in reduced tension forces within the shear reinforcement and thus in a reduced area of reinforcement required. In the program, you decide, which inclination the strut should have.

As shown above, according to the German National Annex, the magnitude of the minimum angle of the inclined strut depends on the applied internal forces V_{Ed} and N_{Ed} that are not available to the program before the calculation. This means, the verification of the minimum strut angle defined by the user is carried out only during the calculation. If it is defined as too small, the program automatically takes the minimum angle of the inclined strut according to the code. However, if even the maximum user-defined angle of inclination is smaller than the angle of inclination of the minimum strut according to the code, the program stops the calculation, showing the corresponding error message.

During the calculation, the minimum level of the strut's inclination is used to determine the design resistance $V_{Rd,max}$ of the concrete compression strut. If it is smaller than the acting shear force V_{Ed} , a steeper strut inclination must be chosen. The strut inclination θ is increased until the following is given:

$$V_{Ed} \leq V_{Rd,max}$$

The strut angle of inclination found in this way results in the smallest shear reinforcement.

Design shear resistance of concrete compression strut according to EN 1992-1-1:2010 Expression (6.9)

Structural components with a shear reinforcement angle of 90°:

$$V_{Rd,max} = \frac{b_w \cdot z \cdot \alpha_{cw} \cdot v_1 \cdot f_{cd}}{\cot \theta + \tan \theta} \quad 6.9$$

or inclined shear reinforcement:

$$V_{Rd,max} = \frac{b_w \cdot z \cdot \alpha_{cw} \cdot v_1 \cdot f_{cd} \cdot (\cot \theta + \cot \alpha)}{1 + \cot \theta^2} \quad 6.14$$

where

- b_w : Width of cross-section
- z : Lever arm of internal forces
- α_{cw} : Factor for considering stress conditions in compression chord
 $\alpha_{cw}=1.0$ for non-prestressed structural systems
- v_1 : Reduction factor for concrete strength in case of shear cracks
 $v_1=0.6$ for $f_{ck} \leq 60 \text{ N/mm}^2$
 $v_1= \max(0.5; 0.9 \cdot f_{ck}/200)$ for $f_{ck} > 60 \text{ N/mm}^2$
- f_{cd} : Design value of concrete compressive strength
- θ : Angle between concrete compressive strut and the structural component axis perpendicular to the shear force
- α : Angle between the shear reinforcement and the structural component axis perpendicular to the shear force

4.6.4 Variants of the Check of Shear Force

The presented checks of shear force are first and foremost intended for rectangular cross-sections uniaxially subjected to shear that are neither fully cracked nor fully compressed.

The program shows the cross-section as fully cracked if a tensile force is applied to all points used for the cross-section's definition. A cross-section is considered to be fully compressed in two cases: on the one hand, if a tensile force is applied to all rebars, on the other, if the shear force resistance $V_{Rd,c}$ without shear force reinforcement $V_{Rd,c}$ yields a negative value.

The following table provides an overview of the forms of the check of shear force for the **rectangular** cross-section.

Deformation or loading of the cross-section	EN 1992-1-1:2010	
	Uniaxial	Biaxial
Cross-section completely cracked	No design possible	No design possible
Negative shear force resistance	No design possible	No design possible
Cross-section fully compressed	Check: $V_{Rd,c} \geq V_{Ed}$ $V_{Rd,c}$ according to (6.4) in 6.2.2	Check: allowed $\tau \geq \text{prov } \tau$ allowed τ derived from (6.4) in 6.2.2
Cross-section normally cracked (no cross-section reinforcement)	Check: $V_{Rd,c} \geq V_{Ed}$ $V_{Rd,c}$ according to (6.2) in 6.2.2	Check: $V_{Rd,c} \geq V_{Ed}$ $V_{Rd,c}$ according to (6.2) in 6.2.2 Determine b_w and d
Cross-section normally cracked (shear reinforcement)	Check: $V_{Rd,max} \geq V_{Ed}$ $V_{Rd,max}$ according to (6.9) or (6.14) $V_{Rd,s} \geq V_{Ed}$ $V_{Rd,s}$ according to (6.8) or (6.13) $z = 0.9 \cdot d$	Check: $V_{Rd,max} \geq V_{Ed}$ $V_{Rd,max}$ according to (6.9) or (6.14) $V_{Rd,s} \geq V_{Ed}$ $V_{Rd,s}$ according to (6.8) or (6.13) Determine z and b_w

Figure 4.46: Forms of the check of shear force for the rectangular cross-section

In the case of a circular cross-section, there is almost always a uniaxial cross-sectional loading, because a resulting shear force V_{Ed} is formed from the applied shear forces V_z and V_y . The following table shows an overview of the forms of the check of shear force for the **circular** cross-section.

Deformation or loading of the cross-section	EN 1992-1-1:2010
	Uniaxial or biaxial
Cross-section completely cracked	No design possible
Negative shear force resistance	No design possible
Cross-section fully compressed	Check: allowed $\tau \geq \text{prov } \tau$ allowed τ derived from (6.4) in 6.2.2
Cross-section normally cracked (no cross-section reinforcement)	Check: $V_{Rd,c} \geq V_{Ed}$ $V_{Rd,c}$ according to (6.2) in 6.2.2 Determine b_w and d
Cross-section normally cracked (shear reinforcement)	Check: $V_{Rd,max} \geq V_{Ed}$ $V_{Rd,max}$ according to (6.9) or (6.14) $V_{Rd,s} \geq V_{Ed}$ $V_{Rd,s}$ according to (6.8) or (6.13) Determine z and b_w

Figure 4.47: Overview of the forms of the check of shear force for the circular cross-section

4.6.5 Check of Shear Force

In this chapter, the checks for a biaxial shear loading of rectangular cross-sections are presented. These include the determination of **d**, **b_w** and **z**.

4.6.5.1 Cracked Cross-Section

If the shear forces $V_{Ed,y}$ and $V_{Ed,z}$ act simultaneously on a cross-section, the applied shear force V_{Ed} is obtained by quadratic combination.

$$V_{Ed} = \sqrt{V_{Ed,y}^2 + V_{Ed,z}^2}$$

The applied shear force V_{Ed} is to be compared with the shear resistance.

The equations in 4.6.1 include the quantities depth **d**, width of component **b_w**, and the lever arm **z**. However, these quantities are not as obvious as in the case of a uniaxially loaded rectangular cross-section.

The effective depth d , width of structural component b_w , and lever arm z of the internal forces are to be determined separately first. In the case of a biaxially loaded rectangular cross-section, the following layout can appear in the concrete compression zone:

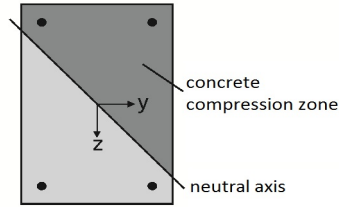


Figure 4.48: Rectangular cross-section subjected to biaxial bending

Then, the effective depth d is determined as distance between the centroidal position of the tensioned rebars and the corner that is the furthest from it and to which a compression stress is applied.

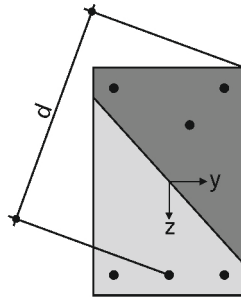


Figure 4.49: Effective depth

To determine the effective depth d , the centroidal position of the tensile forces of all tensioned rebars has to be determined first. Its coordinates are denoted by y_{st} and z_{st} .

The force in a rebar is signified by $F_{st,i}$. The index „ i “ refers to the number of the relevant rebar. Thus, the coordinates of the rebar are signified by $y_{st,i}$ and $z_{st,i}$. The centroidal position of the tensile forces of all tensioned rebars are determined as:

$$y_{st} = \frac{\sum_{i=0}^n y_{st,i} \cdot F_{st,i}}{\sum_{i=0}^n F_{st,i}}$$

$$z_{st} = \frac{\sum_{i=0}^n z_{st,i} \cdot F_{st,i}}{\sum_{i=0}^n F_{st,i}}$$

Here, only the positive (that is, tensile) forces are considered in the rebars.

For the example of the rectangular cross-section depicted above, the lever arm z represents the connection between the location of the resulting concrete compressive force and the centroidal position of the tensile forces of all tensioned rebars.

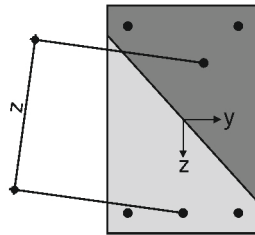


Figure 4.50: Lever of internal forces

To determine the position of the compressive force F_c , the force F_c is to be determined with the aid of the applied axial force and provided tensile and compressive forces acting on the rebars.

$$F_c = N_{Ed} - \left(\sum_{i=0}^n F_{st,i} + \sum_{i=0}^n F_{sc,i} \right)$$

Now, the coordinates y_c and z_c of the resulting compressive force F_c can be determined:

$$y_c = \frac{M_z - \sum_{i=0}^n y_{sc,i} \cdot F_{sc,i}}{F_c}$$

$$z_c = \frac{M_y - \sum_{i=0}^n z_{sc,i} \cdot F_{sc,i}}{F_c}$$

Finally, the lever arm z can be determined:

$$z = \sqrt{(y_c - y_{st})^2 + (z_c - z_{st})^2}$$

In order to apply the equations presented at the beginning of this chapter, the component width b_w has to be calculated first.

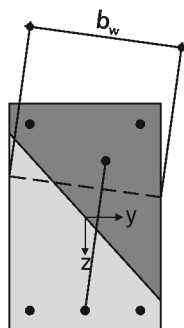


Figure 4.51: Width of component b_w

The width is always perpendicular to the previously calculated lever arm z and intersects with to edges of the rectangular cross-section.

If these intersected edges face each other as in the example above, the cross-section width b_w to be applied is constant along the lever arm z . In the case of two vertically perpendicular intersected edges, the cross-section width changes along the lever arm. The smallest cross-section width b_w is used.

4.6.5.2 Fully Compressed Cross-Section

Design according to EN 1992-1-1:2010

In the case of a fully compressed cross-section, there will be a positive value for the design shear resistance $V_{Rd,c}$ without shear reinforcement. However, the preconditions for the empirical equation are no longer met. In clause 6.2.2 of EN 1992-1-1:2010, the Expression (6.4) for unreinforced concrete is given.

$$V_{Rd,c} = \frac{l \cdot b_w}{S} \cdot \sqrt{\left(\frac{f_{ctk;0.05}}{\gamma_c}\right)^2 - \alpha_1 \cdot \sigma_{cp} \cdot \frac{f_{ctk;0.05}}{\gamma_c}}$$

Thus, this code gives an expression that is independent of the cross-section of a reinforcement in tension and, therefore, allows for a design of the fully compressed cross-sections.

It may not be applied if the tension stresses of concrete are smaller than $f_{ctk;0.05} / \gamma_c$. To verify this precondition, we reanalyze the definition points of the concrete cross-section. If none of these points has a tensile force, the Expressions (6.4) is used.

To be applicable for a biaxial shear load, however, it has to be modified. If we substitute the shear force resistance $V_{Rd,c}$ by the modulus of the applied shear force V_{Ed} in the equation and convert it as follows, the left-hand side of the equation contains a shear stress, whereas the right-hand side of the equation shows the allowable shear stress.

$$\frac{|V_{Ed}| \cdot S}{l \cdot b_w} \leq \sqrt{\left(\frac{f_{ctk;0.05}}{\gamma_c}\right)^2 - \alpha_1 \cdot \sigma_{cp} \cdot \frac{f_{ctk;0.05}}{\gamma_c}}$$

As the cross-section is uncracked, the concrete shows an isotropic material behavior like steel.

Rectangular cross-section

As common for steel construction, the shear stress to be compared can be determined by a simple superposition. Thus, the design is carried out as follows:

$$\sqrt{\left(\frac{|V_{Ed,z}| \cdot S_y}{I_y \cdot y}\right)^2 + \left(\frac{|V_{Ed,y}| \cdot S_z}{I_z \cdot z}\right)^2} \leq \sqrt{\left(\frac{f_{ctk;0.05}}{\gamma_c}\right)^2 - \alpha_1 \cdot \sigma_{cp} \cdot \frac{f_{ctk;0.05}}{\gamma_c}}$$

If we introduce the variables prov τ and perm τ for both sides of the equation, we obtain the following equations:

$$\text{prov. } \tau = \sqrt{\left(\frac{|V_{Ed,z}| \cdot S_y}{I_y \cdot y}\right)^2 + \left(\frac{|V_{Ed,y}| \cdot S_z}{I_z \cdot z}\right)^2}$$

$$\text{allow. } \tau = \sqrt{\left(\frac{f_{ctk;0.05}}{\gamma_c}\right)^2 - \alpha_1 \cdot \sigma_{cp} \cdot \frac{f_{ctk;0.05}}{\gamma_c}}$$

Circular cross-section

For the circular cross-section, on the other hand, the provided shear stress τ (see above) is determined by using the following expression:

$$prov. \tau = \sqrt{\left(\frac{V_{Ed,z} \cdot S_y}{I_y \cdot d}\right)^2 + \left(\frac{V_{Ed,y} \cdot S_z}{I_z \cdot d}\right)^2}$$

The allowable shear stress allowable τ is identical to the one for the rectangular cross-section.

Thus, the shear force design criterion for a fully compressed cross-section subjected to shear can be expressed both for rectangular and circular cross-sections as follows:

$$\text{Design criterion} = \frac{prov \tau}{allow \tau}$$

4.6.6 Check of Shear Force in Circular Cross-Section

4.6.6.1 Cracked Cross-Section

If a cross-section is loaded exclusively by the shear force in direction of a cross-section axis, the acting shear force V_{Ed} is equal to this internal force.

If the cross-section is simultaneously loaded by the shear forces $V_{Ed,y}$ and $V_{Ed,z}$, the applied shear force V_{Ed} is obtained by quadratic combination.

$$V_{Ed} = \sqrt{V_{Ed,y}^2 + V_{Ed,z}^2}$$

The applied shear force V_{Ed} is to be compared with the shear resistance.

All expressions in the standard used for determination of the shear force resistance assume a rectangular cross-section.

All these expressions contain the quantities depth d , width of component b_w , and the lever arm z . To use these expressions, these quantities must be determined for the circular cross-section first.

As an example, the following layout of the concrete compression zone is assumed in the cross-section:

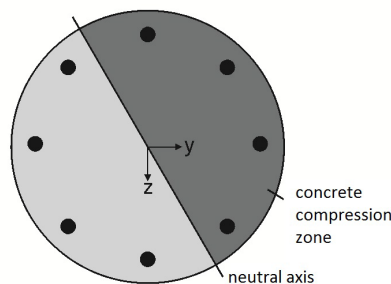


Figure 4.52: Circular cross-section with concrete compression zone

The effective depth d is determined as distance between the centroid of the tensioned rebars and the edge of the cross-section that is the farthest away and contains a compressive stress.

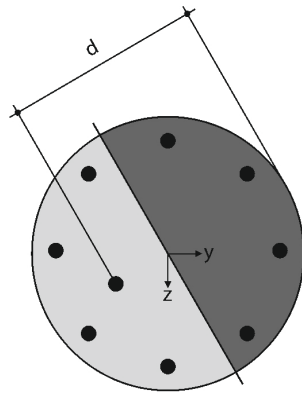


Figure 4.53: Effective depth

To determine the effective depth d , the centroidal position of the tensile forces of all tensioned rebars has to be determined first. Its coordinates are signified by y_{st} and z_{st} .

The force in a rebar is signified by $F_{st,i}$. The index „ i “ refers to the number of the relevant rebars. Thus, the coordinates of a rebar are signified by $y_{st,i}$ and $z_{st,i}$. The centroidal position of the tensile forces of all tensioned rebars are determined as:

$$y_{st} = \frac{\sum_{i=0}^n y_{st,i} \cdot F_{st,i}}{\sum_{i=0}^n F_{st,i}}$$

$$z_{st} = \frac{\sum_{i=0}^n z_{st,i} \cdot F_{st,i}}{\sum_{i=0}^n F_{st,i}}$$

Only the positive (that is, tensile) forces are considered in the rebars.

For the example of the circular cross-section depicted above, the lever arm z represents the connection between the location of the resulting concrete compressive force and the centroidal position of the tensile forces of all tensioned rebars.

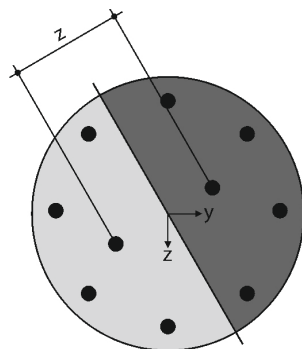


Figure 4.54: Lever of internal forces

To determine the position of the compressive force F_C , the force F_C is to be determined with the aid of the applied axial force and provided tensile and compressive forces in the rebars.

$$F_C = N_{Ed} - \sum_{i=0}^n F_{st,i}$$

Now, the coordinates y_c and z_c of the resulting compressive force F_C can be determined.

$$y_c = \frac{M_z - \sum_{i=0}^n y_{st,i} \cdot F_{st,i}}{F_C}$$

$$z_c = \frac{M_y - \sum_{i=0}^n z_{st,i} \cdot F_{st,i}}{F_C}$$

Finally, the lever arm z can be determined:

$$z = \sqrt{(y_c - y_{st})^2 + (z_c - z_{st})^2}$$

In order to apply the equations presented at the beginning of this chapter, the width of component b_w has to be calculated first.

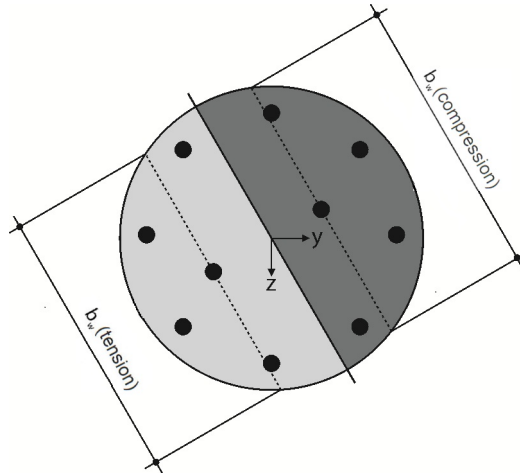


Figure 4.55: Width of component b_w

The width is always perpendicular to the previously calculated lever arm z and intersects with two edges of the circular cross-section. A cross-section width is obtained from the centroidal position of the concrete compression zone and from the centroidal position of the tensioned rebars. We use the smallest cross-sections width b_w .

4.6.6.2 Fully Compressed Cross-Section

Design according to EN 1992-1-1:2010

In the case of a fully compressed cross-section, there will be a positive value for the design shear resistance $V_{Rd,c}$ without shear reinforcement. However, the preconditions for the empirical equation are no longer met. In clause 6.2.2 of EN 1992-1-1:2010, Expression (6.4) for unreinforced concrete is given.

$$V_{Rd,c} = \frac{l \cdot b_w}{S} \cdot \sqrt{\left(\frac{f_{ctk;0.05}}{\gamma_c} \right)^2 - \alpha_1 \cdot \sigma_{cp}} \cdot \frac{f_{ctk;0.05}}{\gamma_c}$$

Thus, the code gives an Expression that is independent of the cross-section of a reinforcement subject to tensile forces. The equation allows for a design of the fully compressed cross-sections.

This expression may be applied if the tension stresses of concrete are smaller than $f_{ctk;0.05} / \gamma_c$. To verify this precondition, we reanalyze the definition points of the concrete cross-section. If none of these points has a tensile force, the Expressions (6.2a) or (6.2b) are used.

4.6.7 Shear Reinforcement

The longitudinal reinforcement of columns must be surrounded by transverse reinforcement. The following conditions regarding the minimum diameter of the transverse reinforcement according to EN 1992-1-1:2010, clause 9.5.3 (1) apply:

- Greater than a quarter of the bar diameter of the provided longitudinal reinforcement
- ≥ 6 mm

For the distance between links, EN 1992-1-1:2010 clause 9.5.3(3) specifies that they may not be greater than $s_{cl,tmax}$. $s_{cl,tmax}$ is specified in the National Annexes. The Eurocode recommends for $s_{cl,tmax}$ as the smallest value from the following distances:

- 20 times the smallest longitudinal bar diameter
- Smallest side length of the column
- 400mm

EN 1992-1-1: 2010 9.5.3 (4) specifies that the distances are to be reduced by factor 0.6 at the following locations:

- In column cross-sections within a distance equal to the larger dimension of the column cross-section above or below a beam or slab.
- Near overlapped joints, if the maximum diameter of the longitudinal bars is greater than 14 mm. A minimum of 3 bars evenly placed in the overlap length is required.

Therefore, the program checks if the end points of members and the intermediate points of continuous members are also part of a slab or a beam. Then, the program suggests you to reduce the distances between the links in these areas.

If you allow for this reduction and if the minimum shear reinforcement is governing, this results in areas along the column with different distances between the links.

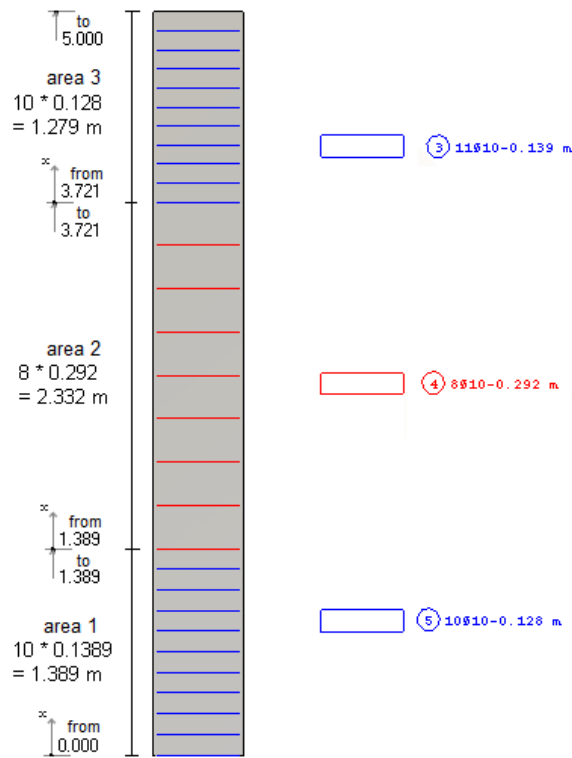


Figure 4.56: Provided shear reinforcement

An area is indicated by an x-value for the start and an x-value for the end. Each area starts with a link and ends with a spacing. If a further area connects to this area, it also starts with a link. If no further area follows, this area ends with a spacing. Within each area, all links have the same spacing. The links within an area are combined with a so-called *Item Number*. The first link is offset by the user-defined minimum of concrete cover from the column start. If also a slab or a beam connects to the column start, the first link is shifted by an additional one-half thickness of this component.

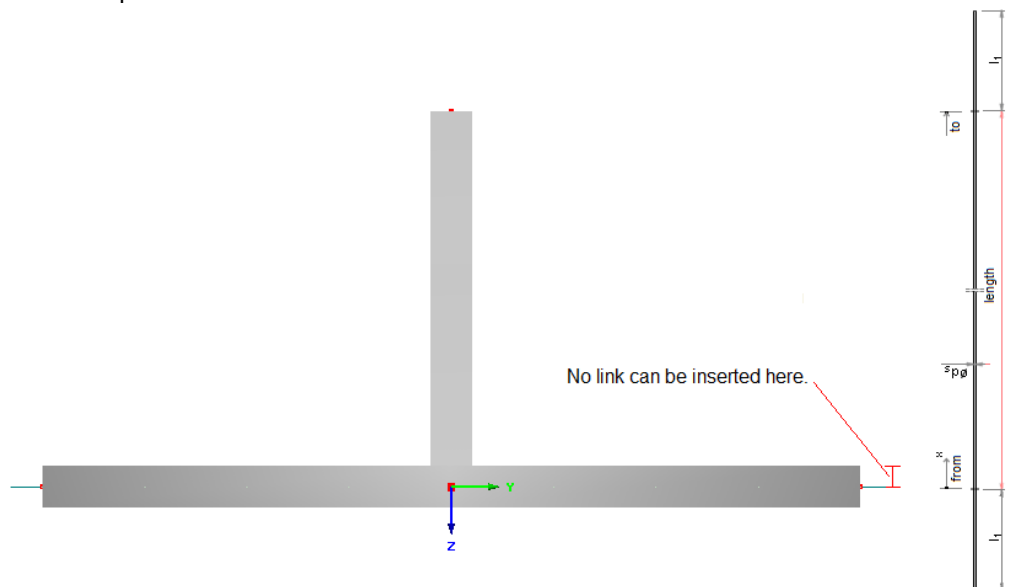


Figure 4.57: Position of the first link above a beam

The x-value for the start or end of an area can later be changed in a results window. It is of great significance whether the start value of the first area, the end value of the last area, or an intermediate value is changed: If a start value of the first area is changed in this way, this area starts at this defined value. If, however, the start or end value of an area is changed in-between and the value does not correspond with the start or end value of the adjacent area, a new intermediate region is inserted.

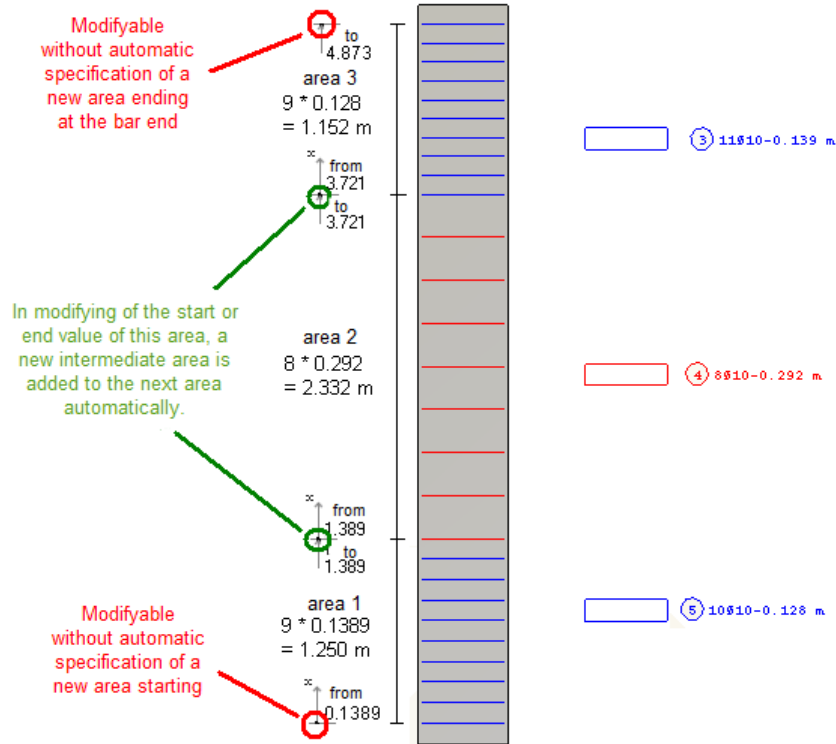


Figure 4.58: Changed link areas

For columns, shear design plays a minor role. In the common literature, you will find only secondary reinforced columns. A graduation of the shear reinforcement is calculated according to the regulations of EN 1992-1-1:2010 only near the supports.

A shear design by x-location is therefore omitted. Instead, the two locations are analyzed for which the absolute greatest values for V_y and V_z result for each member or continuous members. Both the Expressions (6.8) and (6.9) of EN 1992-1-1:2010 include the lever arm z whose length depends on the internal force N and the moments M_y and M_z . Since this lever arm z is an essential part of the expression of the resistant shear force, the locations are analyzed where we obtain

- Maximum axial force N
- Minimum axial force N
- Maximum moment M_y
- Minimum moment M_y
- Maximum moment M_z
- Minimum moment M_z

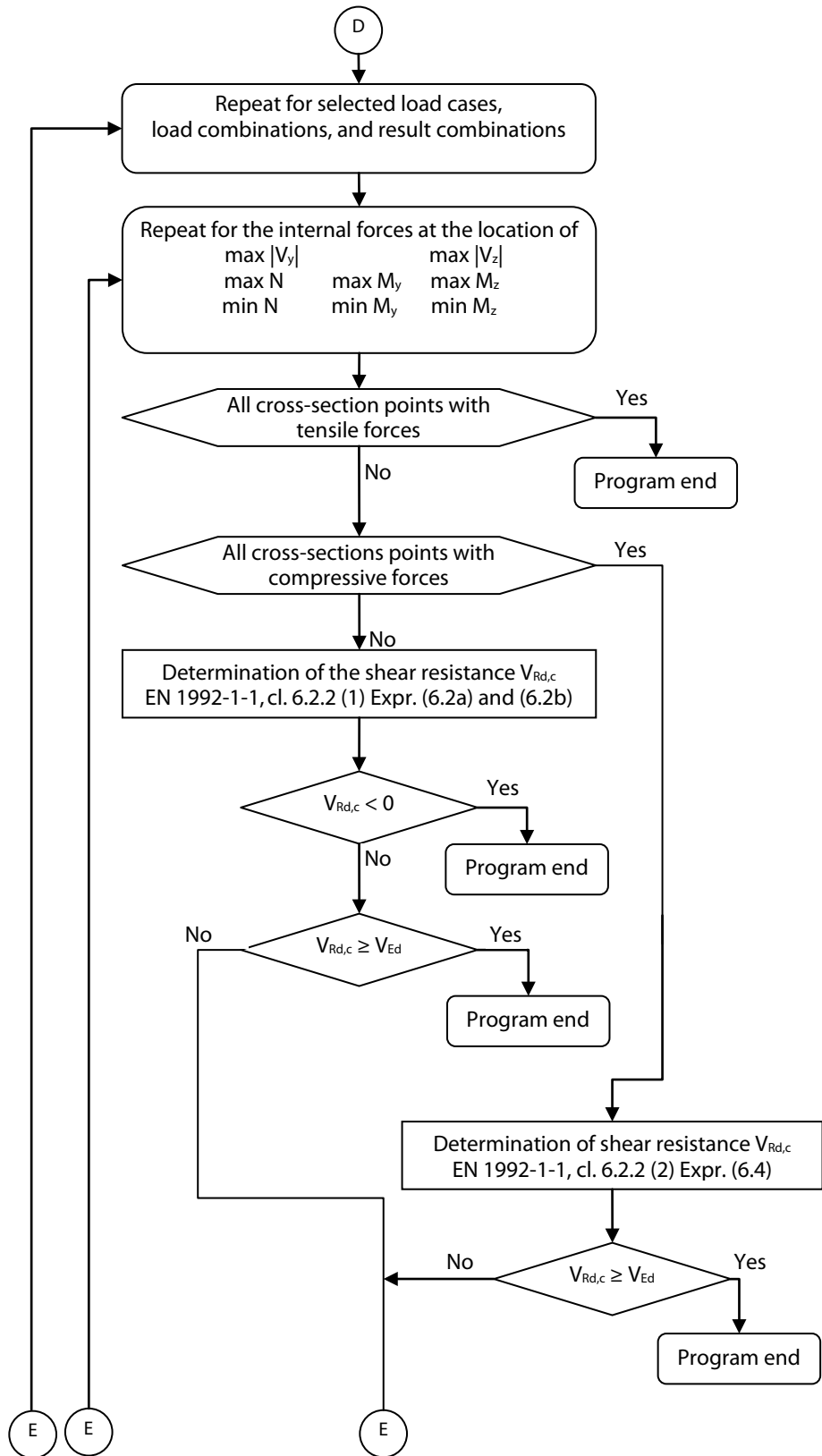
The design is carried out with the internal forces and moments according to linear-static analysis.

4.6.8 Program Flow of Shear Analysis

Now that the equations to be used are presented, we can have a final look on the program flowchart of the shear design.

For the previously determined longitudinal reinforcement, the stresses for the considered internal forces are determined in the corners of the concrete cross-section (circle is represented by a polygon) and in the reinforcement points themselves. The stresses determined there decide if the program is already to be stopped due to a non-designable situation. They also decide how the design shear resistance is to be determined.

4.6.8.1 Part 5.1: Determination of the Shear Resistance

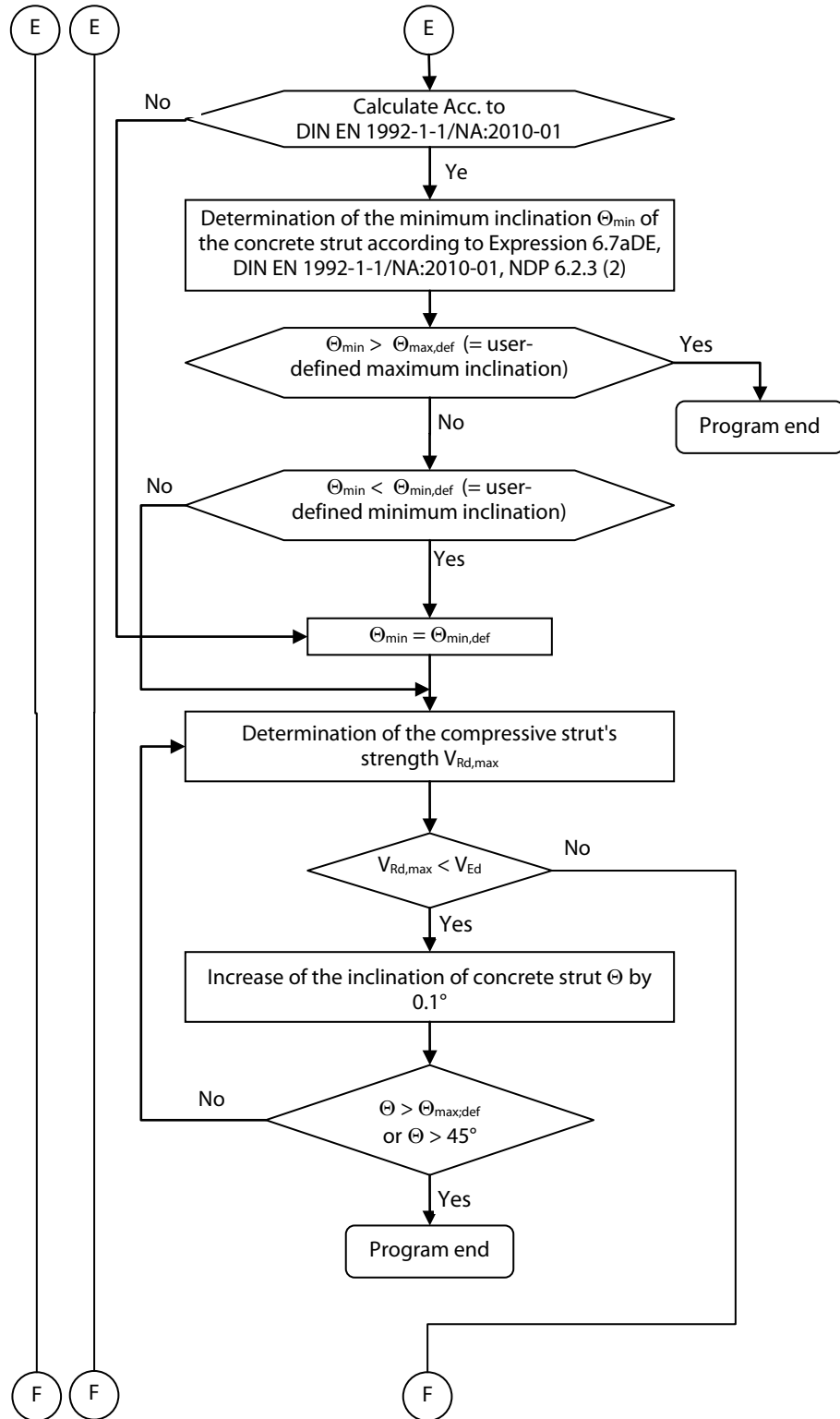


If the cross-section is fully cracked, the program is stopped at this point. The design shear resistance $V_{Rd,ct}$ for the unreinforced concrete is determined for a fully compressed cross-section. Regardless of whether it is sufficient or not, the program is stopped because a shear force reinforcement would not be effective for the fully compressed cross-section.

If all corners of the concrete cross-section are neither compressed nor cracked, the design shear resistance without shear reinforcement is determined according to the provisions of the Eurocode. However, it can still happen that a sufficiently great longitudinal tensile force results in a design shear resistance smaller than zero. In this case, the program is also stopped.

In the second part of the program flowchart for shear design, the limits of the variable strut inclination are determined. Next, these are compared with the user-defined limits of inclination.

4.6.8.2 Part 5.2 : Determination of the Compression Strut's Strength

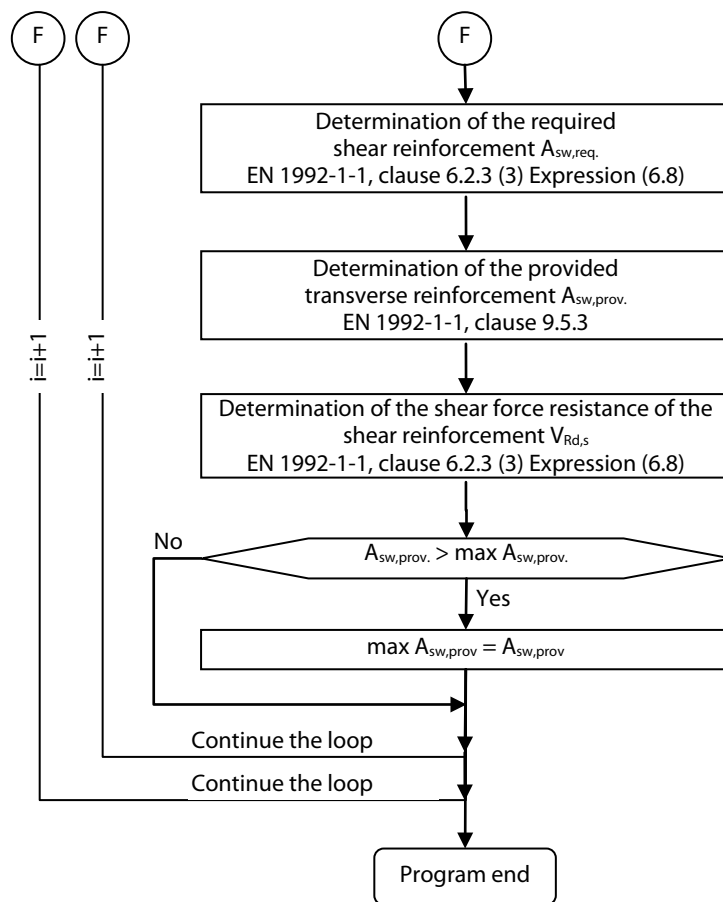


If there is no intersection set between the area of the strut inclination prescribed by the standard and the user-defined area, the design has failed and is discontinued.

Next, the design value of the shear force which can be sustained by the member, limited by crushing of the compression struts, is determined with the smallest possible inclination of the compressive strut. If this value is not sufficient, the inclination of the concrete strut is increased until it is either sufficient or the user-defined maximum allowable inclination of the compressive strut is reached. The maximum reasonable inclination of the strut is 45° because the design value of the shear force which can be sustained by the member, limited by crushing of the compression struts, starts to decrease again from this point on.

If the smaller of both values (maximum user-defined strut inclination or 45°) is exceeded, the design has failed and is discontinued. If a sufficient design value of the shear force which can be sustained by the member, limited by crushing of the compression struts, is obtained earlier, the determination of the required reinforcement is continued.

4.6.8.3 Part 5.3 : Determination of the Transverse Reinforcement



Next, the provided reinforcement is used to determine the design value of the sustainable shear force limited by the resistance of the shear reinforcement.

Finally, the provided shear reinforcement of this loop iteration is compared with the provided shear reinforcement of the previous loop iteration.

The greatest shear reinforcement from all loop iterations then indicates the governing location for the design of the shear resistance with shear reinforcement. The program shows two design criteria for it.

Design criterion 1:

$$\text{Design - criterion} = \frac{V_{Ed}}{V_{Rd,max}}$$

Design criterion 2:

$$\text{Design - criterion} = \frac{V_{Ed}}{V_{Rd,s}} \quad (\text{DIN 1045-01})$$

The criterion for the location of the governing shear force without the shear reinforcement is shown. This is done if only one minimum shear reinforcement was required for the entire member.

$$\text{Design - criterion} = \frac{V_{Ed}}{V_{Rd,c}}$$

The design criterion is determined as the greater design criterion in the directions y and z.

$$\text{Design - criterion} = \frac{V_{Ed}}{V_{Rd,c}} = \max \left\{ \frac{V_y}{V_{Rd,c,y}}; \frac{V_z}{V_{Rd,c,z}} \right\}$$

4.7 Overlaps

4.7.1 Connection Elements on a Column

Columns can connect to various elements in RSTAB. The following figure illustrates these elements.

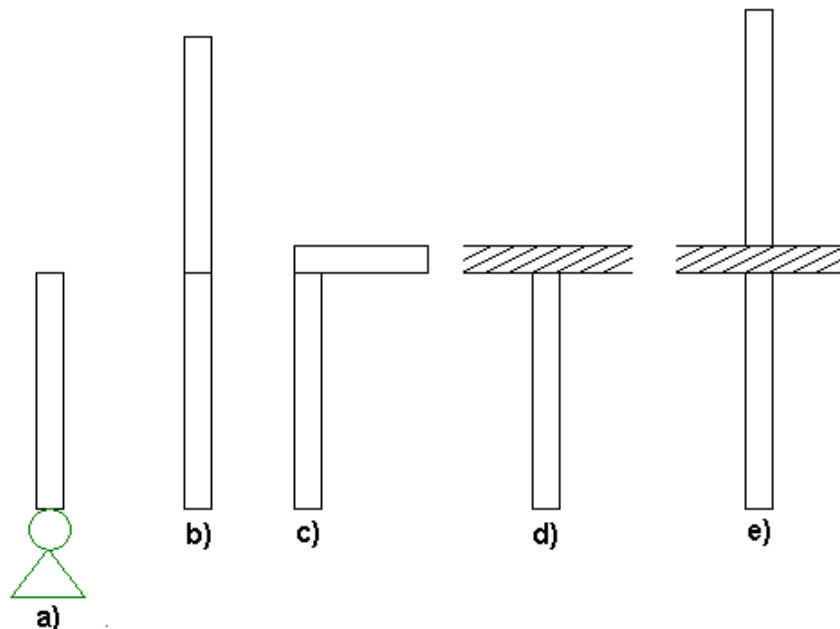


Figure 4.59: a = support, b = continuing column, c = beam, d = slab, e = slab with continuing column

If a support connects to the column, it may result in a connecting reinforcement. Therefore, this connecting reinforcement is not part of the obtained column longitudinal reinforcement. However, you can decide if to reduce the link spacings resisting the transverse tensile forces to 60% of the usually selected link spacings.

If the column connects to a continuing column, you can reduce the spacing but also create an overlap. The longitudinal reinforcement of the columns under consideration is extended by the overlap length l_0 . The determination of this overlap length will be described later.

If a beam or a slab forms a connecting element, you can also change the link spacing.

To form an overlap, the length of overlap l_0 is to be determined first.

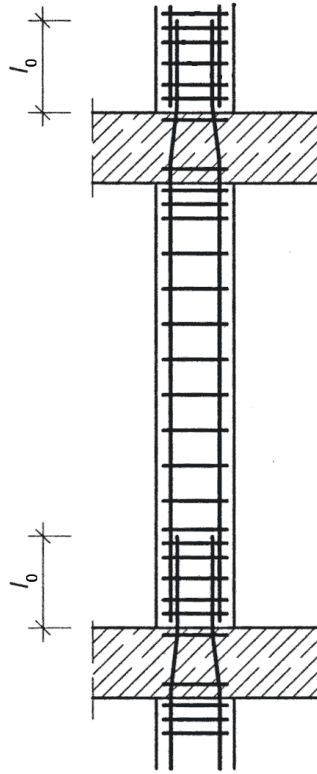


Figure 4.60: Overlap length l_0

The design value of the length of overlap l_0 is determined from the required basic value of the length of anchorage $l_{b,rqd}$ according to DIN EN 1992-1-1 clause 8.4.3.

The required basic value of the anchorage length $l_{b,rqd}$ used to anchor the force $A_s \cdot \sigma_{sd}$ of a member under consideration of a constant bond stress f_{bd} follows from the equation:

$$l_{b,rqd} = (\phi / 4) \cdot (\sigma_{sd} / f_{bd})$$

Here, ϕ is the bar diameter and σ_{sd} is the provided steel stress in the ULS of the bar at the beginning of the length of anchorage. Values for f_{bd} are given in 8.4.2.

$$f_{bd} = 2.25 \cdot \eta_1 \cdot \eta_2 \cdot f_{ctd}$$

η_1 is a factor that takes into account the quality of the bond conditions and the positions of the bar during concreting.

η_2 is a factor for taking account of the bar diameter

f_{ctd} is the design value of the of the concrete tensile strength according to 3.1.6(2)P

If the required basic value of the anchorage length $l_{b,reqd}$ is obtained, we can determine the design value of the length of overlap l_0 according to DIN EN 1992-1-1 clause 8.7.3:

$$l_0 = \alpha_1 \cdot \alpha_2 \cdot \alpha_3 \cdot \alpha_4 \cdot \alpha_5 \cdot \alpha_6 \cdot l_{b,reqd} \geq l_{0,min}$$

where

$l_{b,reqd}$ is the required basic value of the anchorage length

$$l_{0,min} \geq \max(0.3 \cdot \alpha_6 \cdot l_{b,reqd}; 15 \cdot \phi; 200\text{mm})$$

$\alpha_1, \alpha_2, \alpha_3, \alpha_4, \alpha_5$ coefficients (given in Table 8.2 in DIN EN 1992-1-1)

$$\alpha_6 = (\rho_1 / 25)^{0.25} \leq 1.5 \text{ or } 1.0$$

ρ_1 is the percentage of the reinforcement overlapped within $0.65 \cdot l_0$ (measured from the middle of the overlap length under consideration).

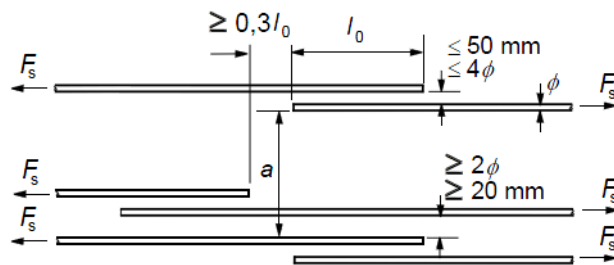
The values for α_6 are included in Table 8.3 in DIN EN 1992-1-1.

4.7.2 Design of Overlaps

The constructional design of overlaps is described in DIN EN 1992-1-1 clause 8.7.2 Laps.

(3) As a rule, the arrangement of overlapped bars should conform to Figure 8.7 and meet the following conditions:

- The clear distance between overlapping bars should not be greater than 4ϕ or 50 mm. Otherwise, the overlap length should be increased by a length equal to the clear space where it exceeds 4ϕ or 50 mm;
- The longitudinal distance between two adjacent overlaps may not be less than 0.3 times the overlap length l_0 ;
- In case of adjacent laps, the clear distance between adjacent bars should be not less than 2ϕ or 20 mm.



Adjacent laps

Figure 4.61: Design of overlaps

(4) When the provisions from clause (3) are met, the permissible percentage of lapped bars in tension may be 100% where the bars are all in one layer. Where the bars are in several layers, the percentage should be reduced to 50%. All bars in compression and the transverse reinforcement may be overlapped in one cross-section.

If we consider the choice of a different reinforcement layout, different column dimensions, and the different numbers and diameters obtained from the calculation of the bars to be overlapped, it seems almost impossible to meet these regulations. Therefore, the following conditions must be given for the automatic, secondary design of a reinforcing overlap:

- The cross-section dimensions of the columns to be lapped are the same.
- The same reinforcement layout was chosen for both columns.
- The provided reinforcement is arranged in both columns only in one layer.

The diameter and the number of the rebars can be different in both columns. Upon determination of the coordinates of the cranked rebars, you have to check if within less than $4d_s$ of each of the members at least one rebar of the connecting column is located. If this is not the case, the program informs you that this constellation of the rebar does not allow for an overlap in the columns to be lapped.

The following forms of overlaps are possible.

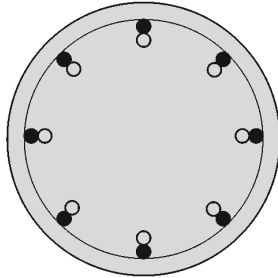


Figure 4.62: Overlap for circular column cross-section

An overlap is possible without restrictions for circular column cross-sections. For rectangular cross-sections, the arrangement of the reinforcement decides whether an overlap is allowable.

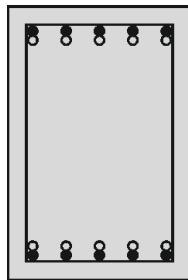


Figure 4.63: Overlap in a rectangular column cross-section - double-sided

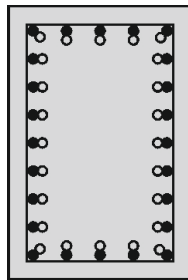


Figure 4.64: Overlap in a rectangular column cross-section - surrounding

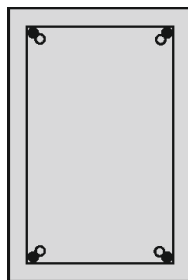


Figure 4.65: Overlap in a rectangular column cross-section - in corners

For double-sided and surrounding reinforcement layout, an overlap is possible without restrictions. For a reinforcement layout in the corners, laps are allowable only for columns that do not have more than one rebar in each corner. Otherwise, the result would be a concentration of reinforcement that does not allow for a compaction of concrete anymore.

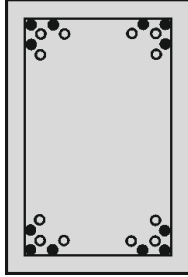


Figure 4.66: No overlap for concentrated corner reinforcement

5. Working with CONCRETE Columns

5.1 Open CONCRETE Columns

To start the add-on module CONCRETE Columns, click

Add-on Modules → Design - Concrete → CONCRETE Columns.

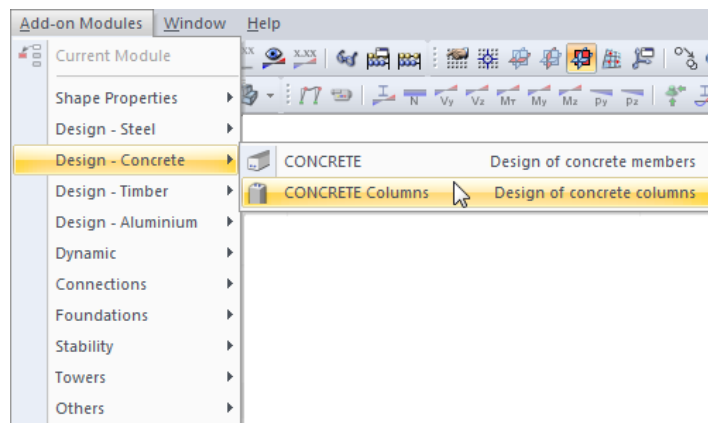


Figure 5.1: Starting CONCRETE Columns via the menu *Add-on Modules*

Alternatively, you can open the add-on module in the Data navigator by double-clicking **CONCRETE Columns**.

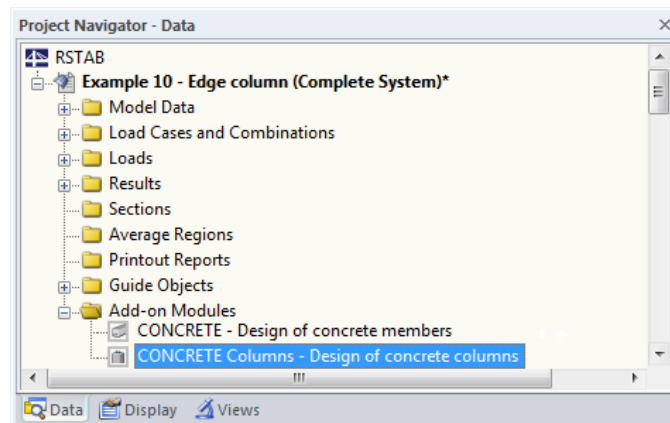


Figure 5.2: Starting CONCRETE Columns via the *Data* navigator

5.2 Windows

There are five input windows that are shown in the module's navigator located on the left.

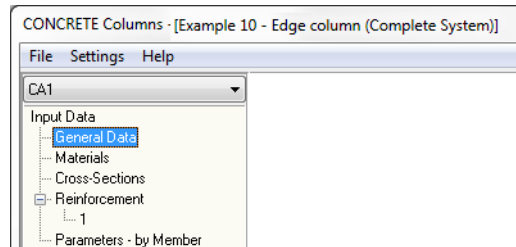


Figure 5.3: Input tables in navigator

The table *Reinforcement* is divided into four different subtables for the individual user-defined reinforcement groups.

The navigator on the left lists all available tables. Above, you will find a list with the possibly already available design cases.

Below the navigator, there are three buttons.



Figure 5.4: Button [Help]

To open the online help, click [Help] or press the function key [F1].



Figure 5.5: Previous table - next table

You can select the masks either by clicking the corresponding entry in the navigator or by browsing them in sequence. To browse the tables, use the function keys [F2] and [F3] or click the buttons shown above.

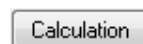


Figure 5.6: Button [Calculation]

Having entered all relevant data, click [Calculation].

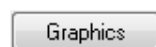


Figure 5.7: Button [Graphics]

To select the graphical results display, click [Graphics]. The program sets the current **CONCRETE Columns** case automatically. For further information on results display and output, see chapter 6 of this manual.

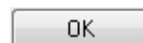


Figure 5.8: Button [OK]

To save all input and results before exiting the module, click [OK].

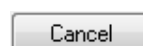


Figure 5.9: Button [Cancel]

To exit **CONCRETE Columns** without saving the data, click [Cancel].

5.3 Input Windows

5.3.1 Window 1.1 General Data

When you open the module **CONCRETE Columns**, the table 1.1 *General Data* appears.

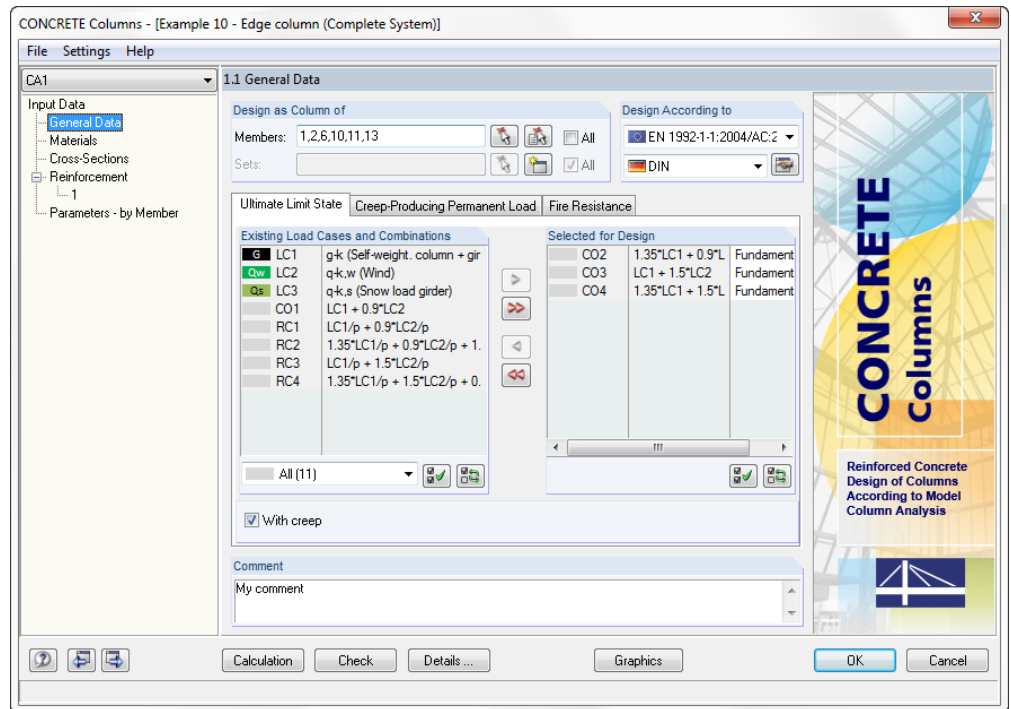


Figure 5.10: Table 1.1 *General Data*, tab *Ultimate Limit State*

In this table, you will also find lists of the existing load cases (LC), load combinations (CO), and result combinations (RC). The load cases, load combinations, or result combinations for which a design is to be carried out, can be selected by clicking them and transferring them to the right list by using the **[>]** button.



Figure 5.11: Button [Add selected case]

The button **[>>]** transfers all entries to the right list.



Figure 5.12: Button [Add all cases]

Similarly, to transfer individual entries to the left side, click **[<]**. To transfer all entries, click **[<<]**.



Figure 5.13: Buttons [Reset selected] and [Reset all]

You can add a note to each design case in the text field *Comment*.



Figure 5.14: Dialog section *Comment*

To manage the individual design cases, use the menu **File**.

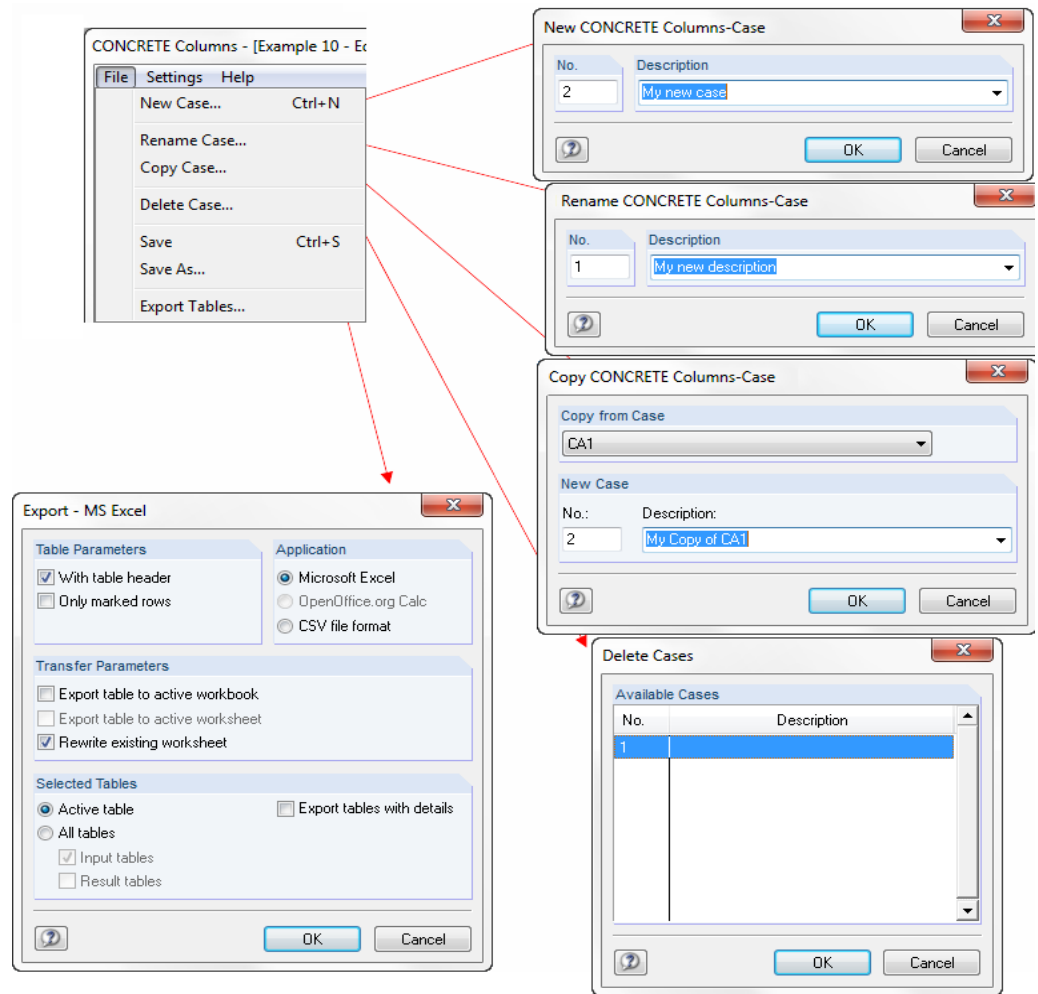


Figure 5.15: Managing the design cases

File → New Case

Another way to create a new design case is to press the key combination [Ctrl]+[N]. The following dialog box opens:

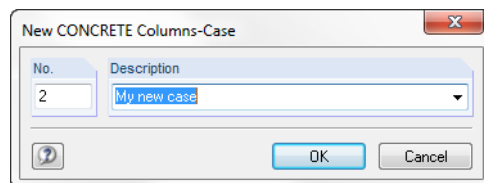


Figure 5.16: Dialog box **New CONCRETE Columns-Case**

A new *No.* and *Description* must be assigned to the new design case. All descriptions that are already used are shown in the list. This drop-down list becomes available when you click the arrow at the lower-right edge of the text field containing the description of the design case.

File → Rename Case

Use this function to rename the current design case. To do this, change the Description. You may also have to choose a different No.

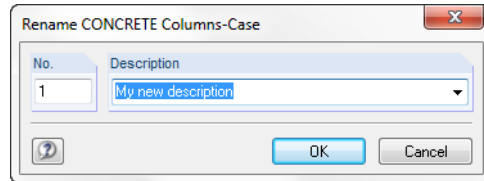


Figure 5.17: Dialog box *Rename CONCRETE Columns-Case*

File → Copy Case

Use this function to copy a design case that is already created. The relevant case must be selected in the upper list first. Enter the name for the copy in the input field *Description*.

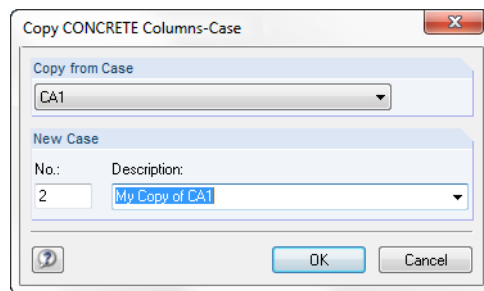


Figure 5.18: Dialog box *Rename CONCRETE Columns-Case*

File → Delete Case

You can select the case that you want to delete in the list. The case is deleted if you exit the dialog by clicking [OK]. If you want to select several cases, click the entries while pressing the [Ctrl] key.

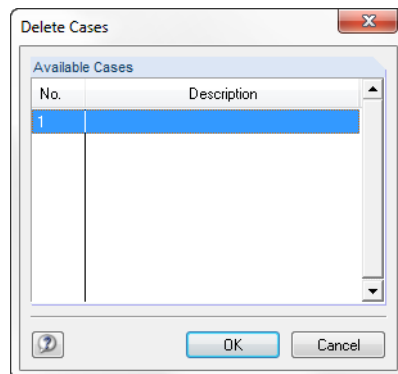


Figure 5.19: Dialog box *Delete Case*

Export → MS Excel

The case can be exported to an MS Excel table.

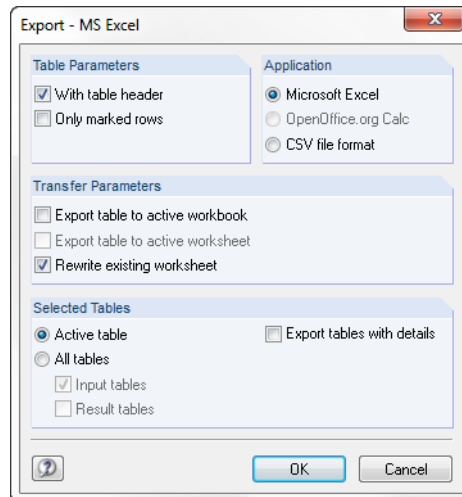


Figure 5.20: Dialog box *Export - MS Excel*

Click **Settings** → **Units and Decimal Places**.

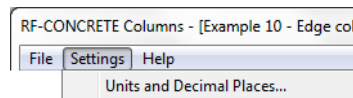


Figure 5.21: Opening the dialog box

In this dialog box, you can specify the units for the design.

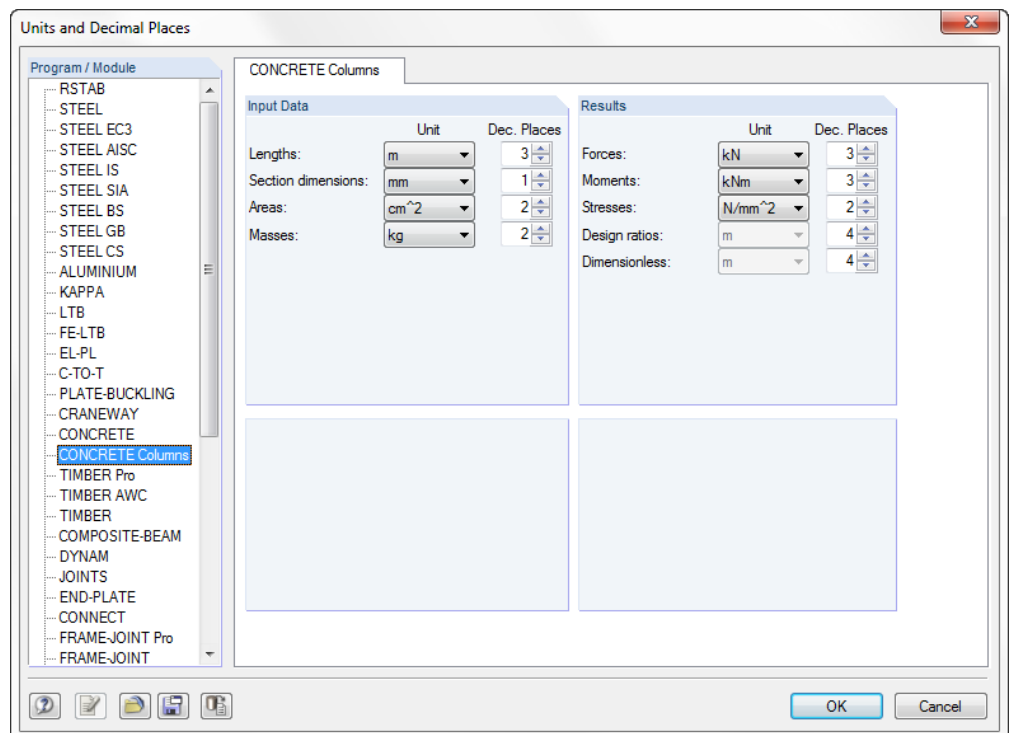


Figure 5.22: Dialog box *Units and Decimal Places*

At the lower left of this dialog box, you will find different buttons with which you can manage the units and the number of their decimal places in *Profiles*.

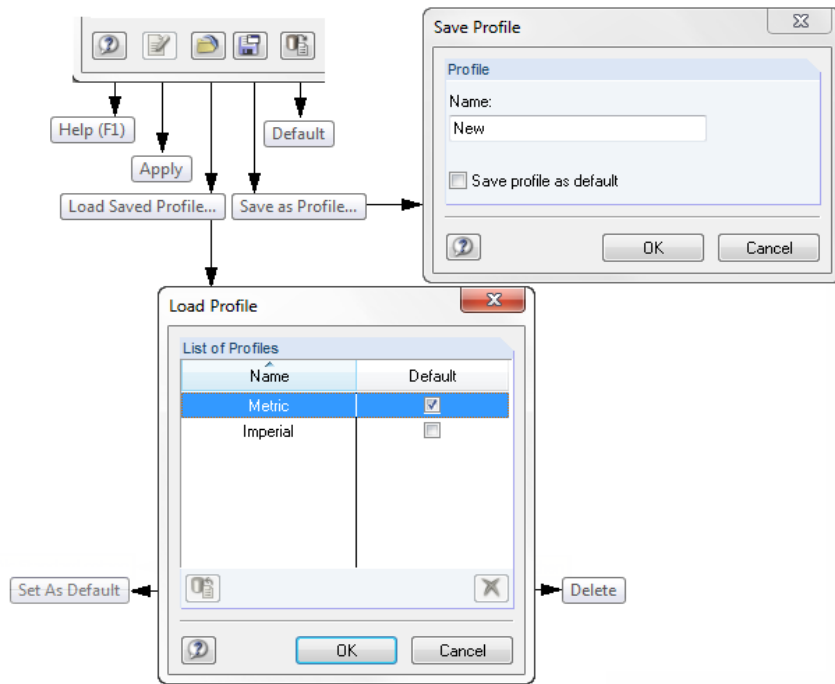


Figure 5.23: Management of the units

To find more information on the add-on module, click the **Help** menu.

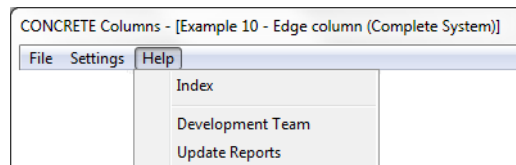


Figure 5.24: Menu item [Help]

In the dialog section **Design as Column** of the window 1.1 *General Data*, you first select the elements of the RSTAB model that you want to design according to the method based on nominal curvature.



Figure 5.25: Selection of the columns to be designed

Type the number of a member in the input field *Members*. Alternatively, you can click the button to the right in order to return to the RSTAB work window and select the relevant column for calculation by clicking it.

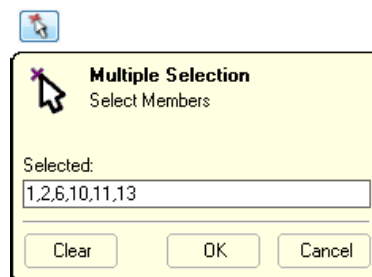


Figure 5.26: Dialog box for selection of members by numbers

This dialog shows the numbers of the selected members. To import them to the module, click [OK].

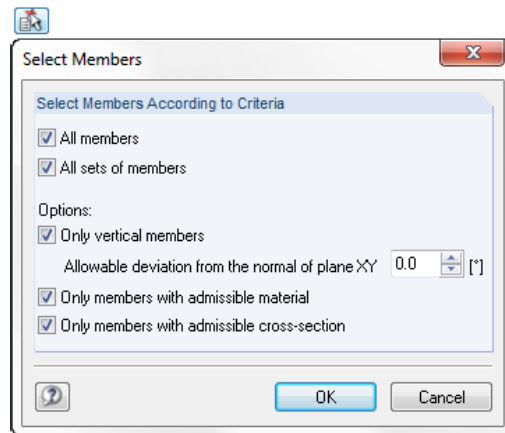


Figure 5.27: Dialog box for selection of members by criteria

The criteria for member selection appear in this dialog box. To import them to the module, click [OK].

If you want to select most of the members of a model, it is recommended to click the check box [All] and to remove the irrelevant members in the way described above.

Similarly, you can select already defined sets of members. If no set of members has been created yet, the text field for sets of members and the corresponding buttons are not available.

To open the dialog box used to create a new set of members in CONCRETE Columns, use the following buttons:

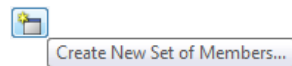


Figure 5.28: Button to create a new set of members

The dialog box *New Set of Members* appears:

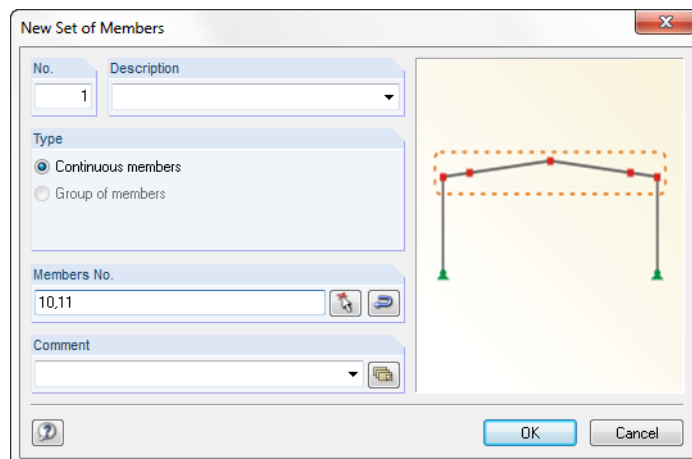


Figure 5.29: Dialog box for creating a new set of members

You can select the code for the design in the dialog section *Design According to Standard* in the window 1.1 *General Data*:

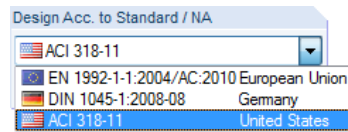


Figure 5.30: Selection of design standard

In addition to that, you can select the check box *With Creep* if these influences are design relevant.

Thus, the tab *Creep-Producing Permanent Load* becomes available. In this tab, you can select the loads that act permanently and, therefore, result in the increase of the additional eccentricity e_2 due to creeping.

According to EN 1992-1-1 clause 5.8.4, this approximate increase of the additional eccentricity e_2 due to creep is to be determined in such a way that the existing second order eccentricity e_2 is multiplied by the factor $(1 + M_{0Eqp} / M_{0Ed})$. The moment M_{0Eqp} results from the loads selected in the second tab *Creep-Producing Permanent Load* of window 1.1. They are assumed as permanently acting and their influence is checked one after the other.

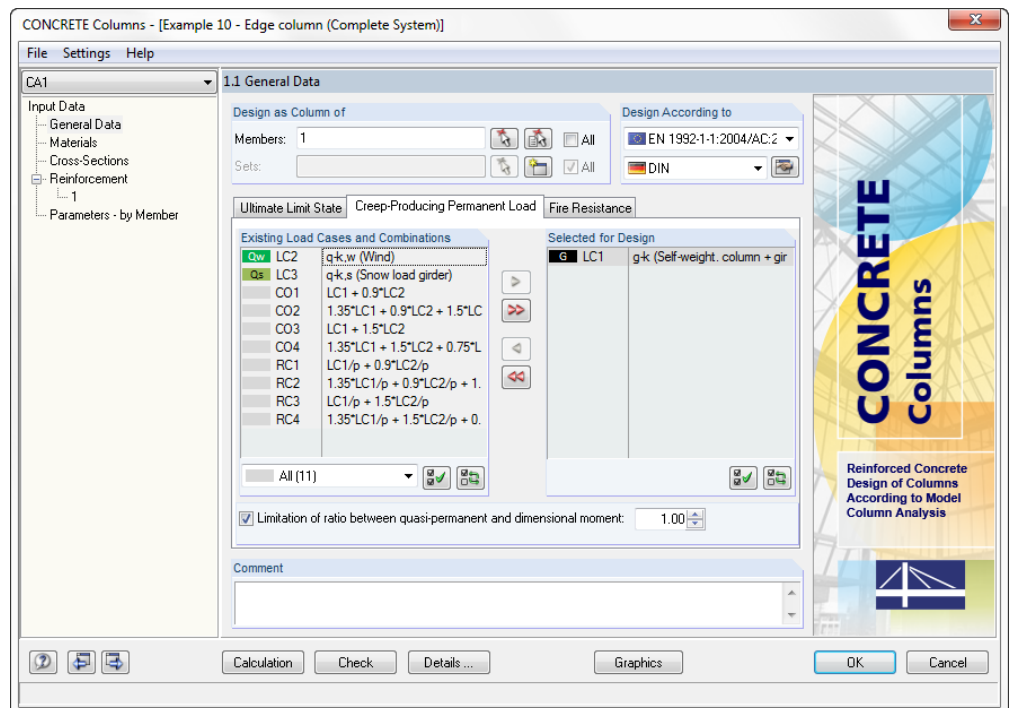


Figure 5.31: Table 1.1 *General Data*, tab *Creep-Producing Permanent Load*

The option *Limitation of ratio between quasi-permanent and dimensional moment* makes it possible to limit the ratio M_{0Eqp} / M_{0Ed} to the defined value (the standard is 1.00) for the calculation of the effective creep coefficient. This option ensures that if $M_{0Eqp} > M_{0Ed}$ the effective final creep coefficient is not increased.

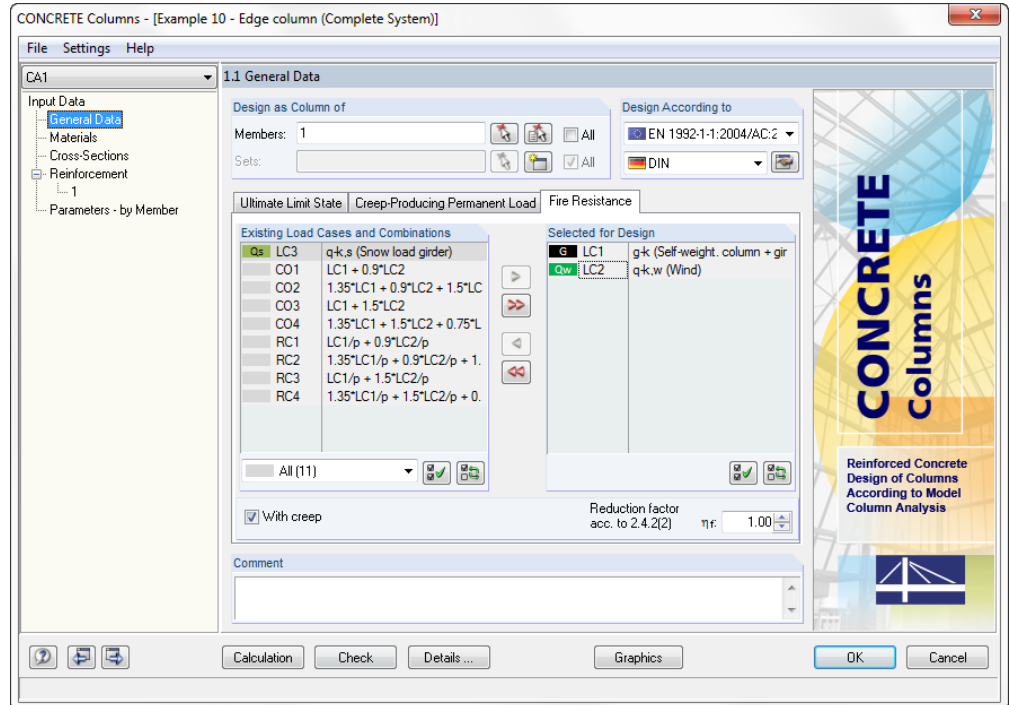


Figure 5.32: Window 1.1 *General Data*, tab *Fire Resistance*

Reduction factor for fire resistance design

The option *Reduction factor acc. to 2.4.2 (2)* allows you to take into account loadings from the design for normal temperature and to reduce these actions by the reduction factor η_{fi} . The reduction factor is to be determined as suggested in EN 1992-1-2 according to 2.4.2 (3). Simplifying, we can use the recommended value $\eta_{fi} = 0.7$.

5.3.2 Window 1.2 Materials

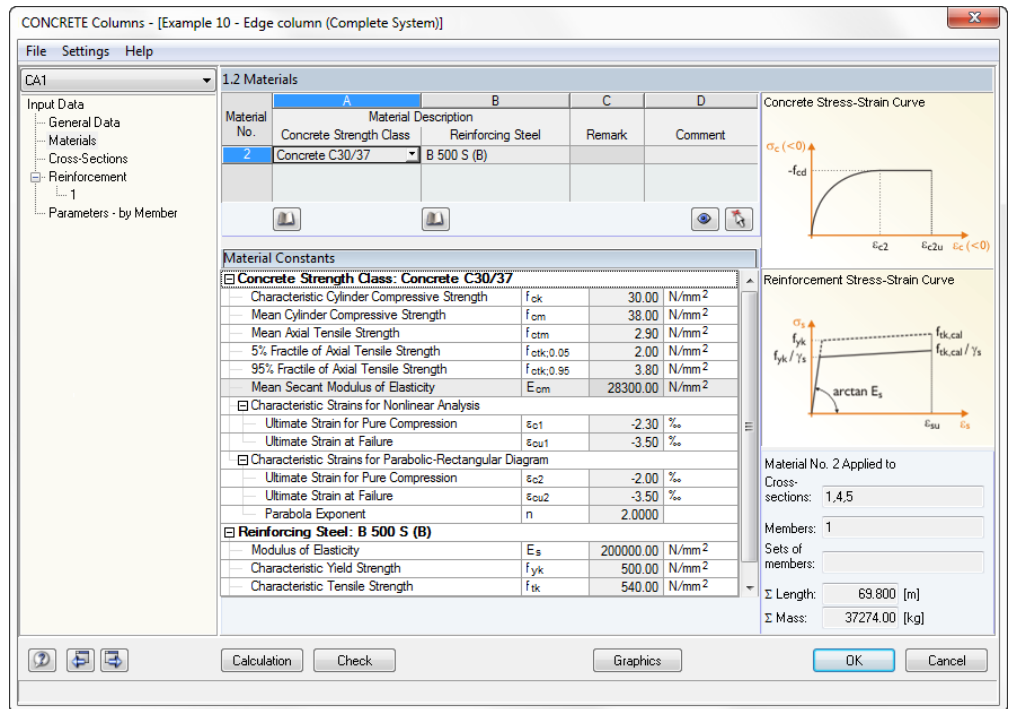


Figure 5.33: Window 1.2 Materials

In this window, the material data of the members to be designed are displayed. The window is subdivided into two parts. Specify the materials for the concrete and reinforcing steel in the upper part. The concrete strength classes are imported from RSTAB but can also be modified in this window.

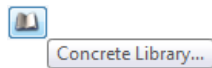


Figure 5.34: Concrete library

To select the type of concrete, click the [Concrete library] button located below the row *Concrete Strength Class*.

The following dialog box appears:

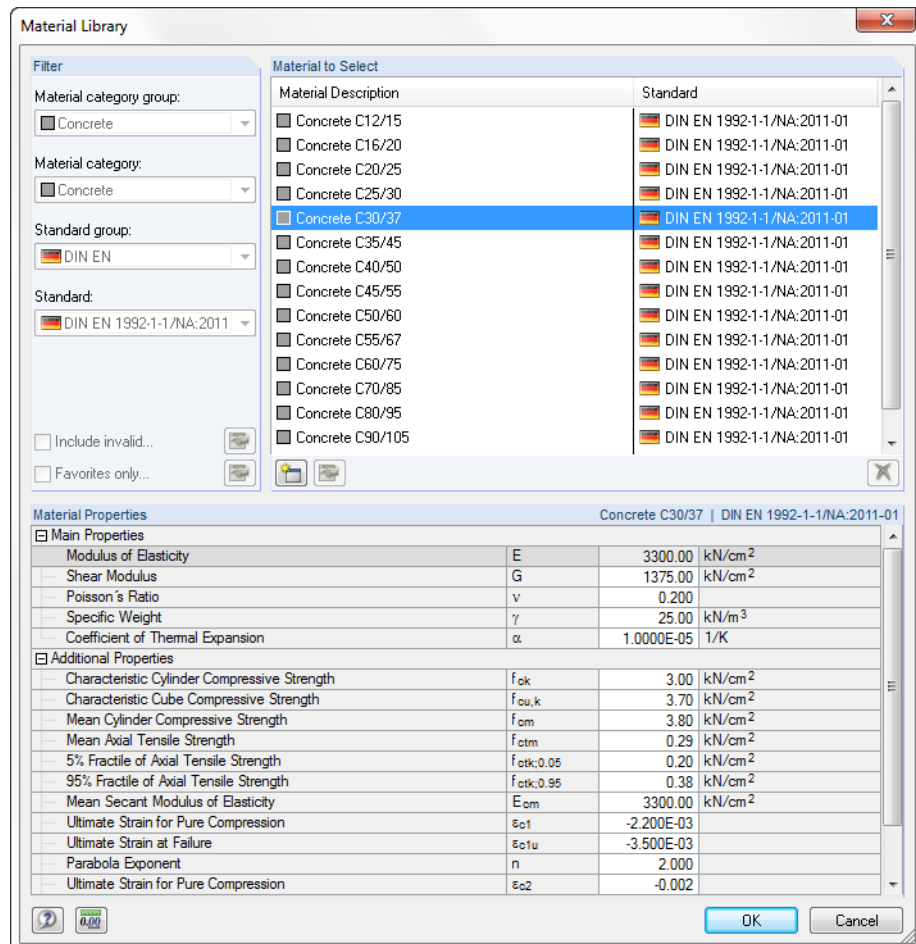


Figure 5.35: Concrete library

This dialog box has three sections. The so-called *Filter* are on the left. However, they cannot be set in this module because the previous selections determine which materials are displayed. All materials are listed in the dialog section *Material to Select*. You can select one of the materials by clicking it. The table in the lower dialog section *Material Properties* shows information about all properties of the materials that are relevant for the RSTAB calculation.

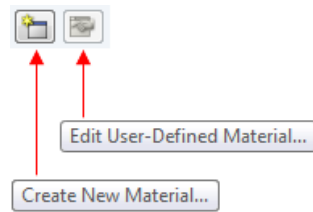


Figure 5.36: Buttons in the material library

To define a customized concrete, click [Create new material]. The following dialog box appears:

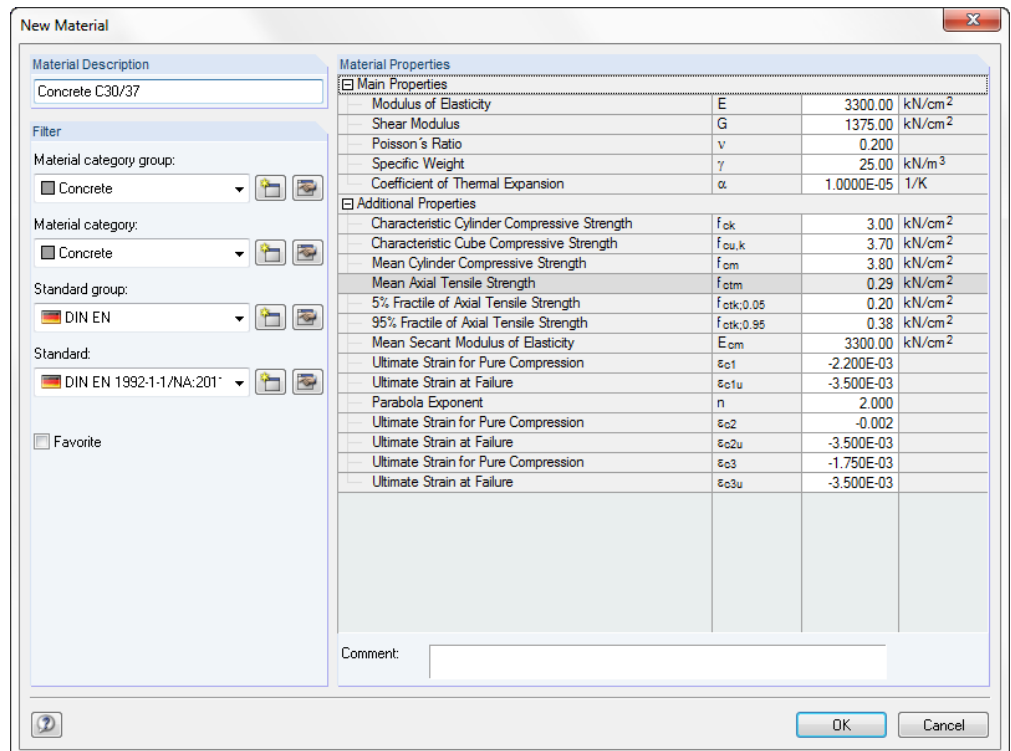


Figure 5.37: Dialog box *New Material*

In addition to the Material Description, you can include all *Material Properties* in the table on the right-hand side. To add the newly created material to the list of the existing materials, click [OK], thus exiting the dialog box.

Select the customized concrete or a concrete with a certain strength class in the concrete library. To transfer it to window 1.2, click [OK].

A reinforcement steel type must be assigned to each concrete strength class. The selection of the steel type is similar to the selection of the concrete strength class. To open this library, click [Reinforcing steel library].

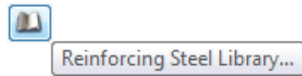


Figure 5.38: Reinforcing steel library

The following dialog box appears:

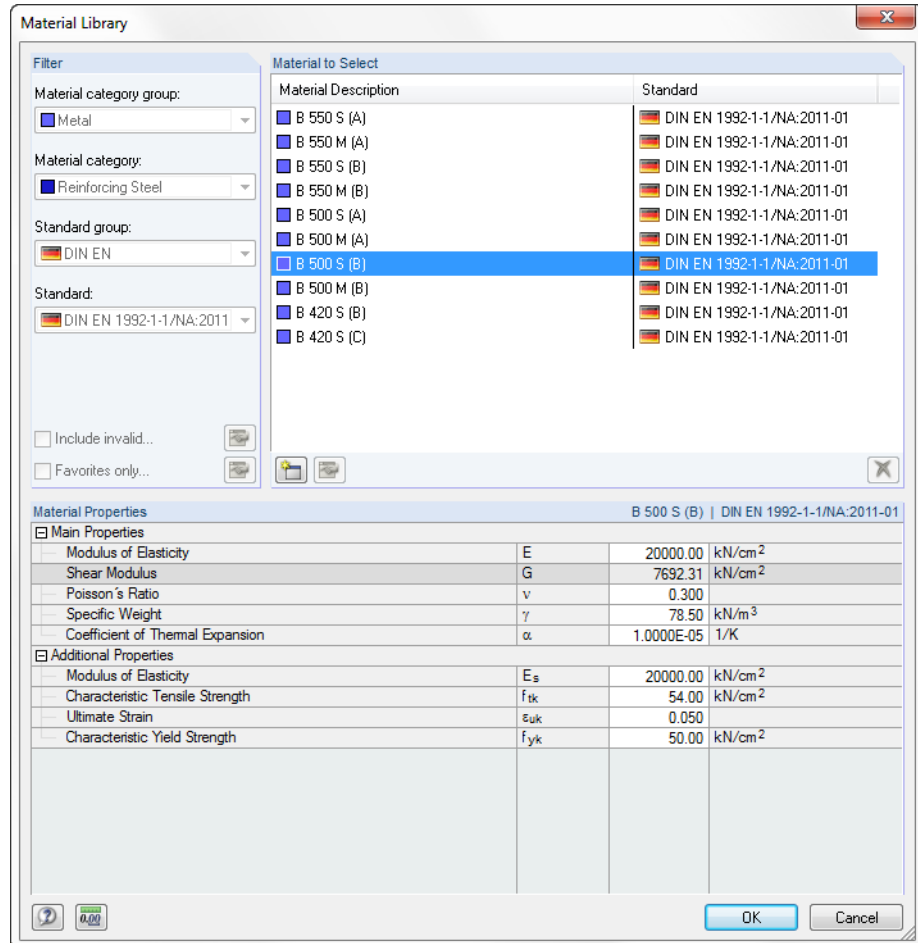


Figure 5.39: Reinforcing steel library

To define customized reinforcing steel, click [New].

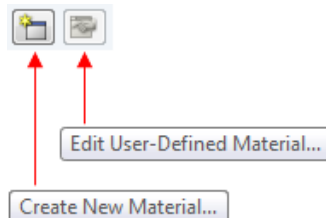


Figure 5.40: Reinforcing steel library buttons

The following dialog box appears:

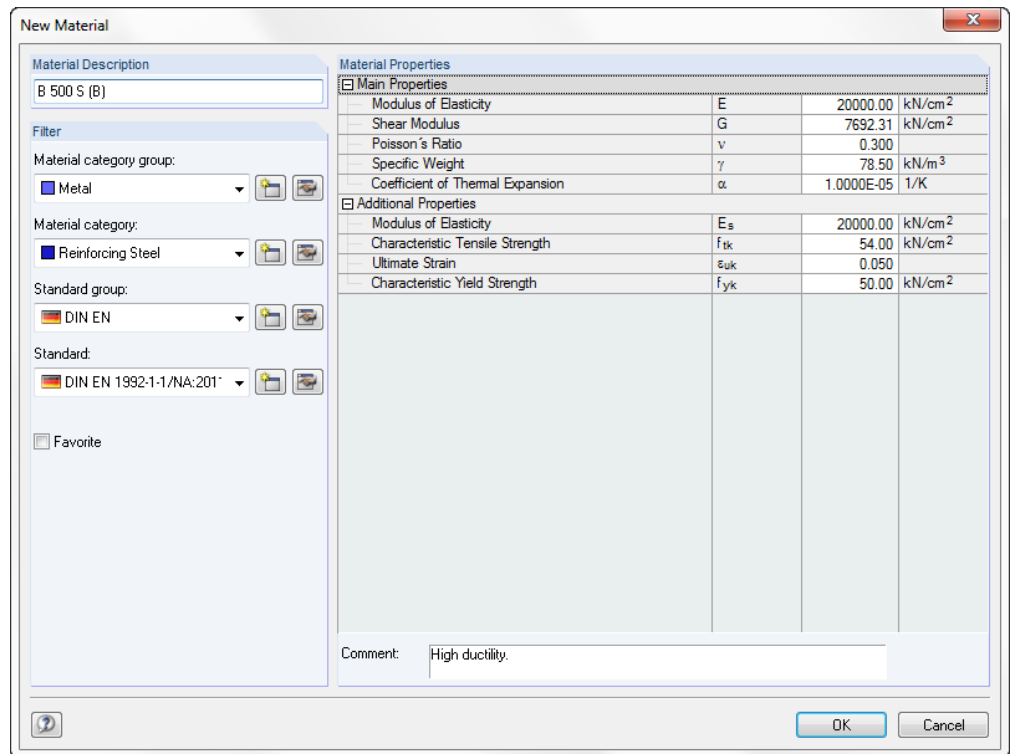


Figure 5.41: Material properties

The specifications are done in the same way as described for concrete.

In the lower part of window 1.2, there is a detail window with the properties of concrete and reinforcing steel selected in the upper table.

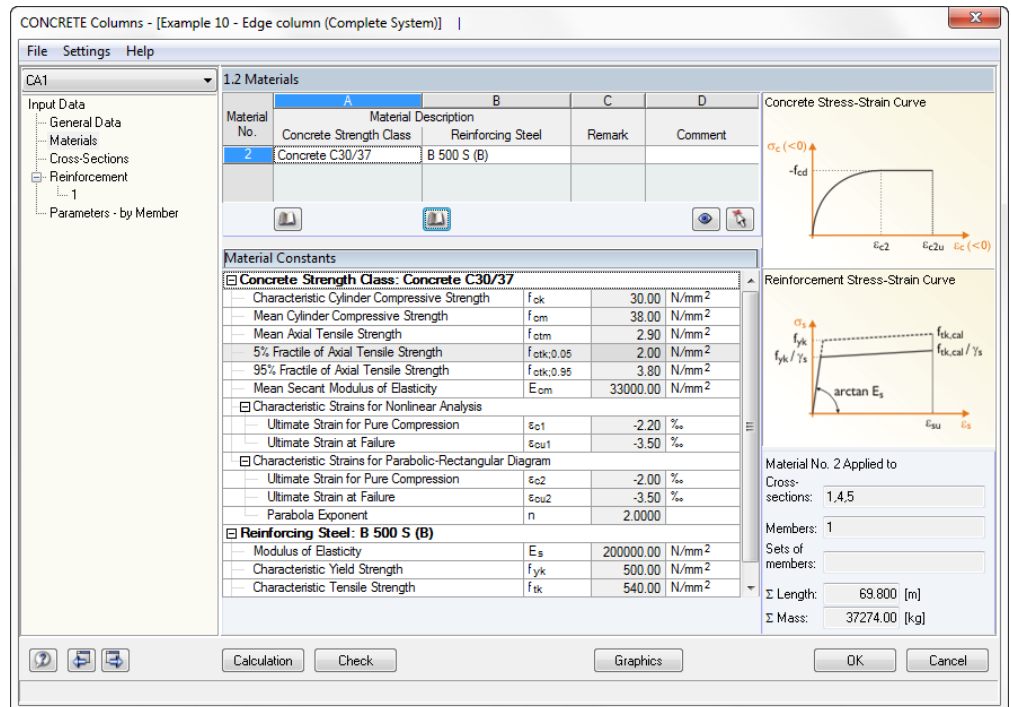


Figure 5.42: Table 1.2 Materials

To the right, you see which materials are used for the members or cross-sections.

In this window, you can change the material properties. However, the design will be carried out with the internal forces and moments determined with the stiffness defined in RSTAB. If the stiffness is modified in CONCRETE Columns and the system under consideration is statically indeterminate, the modified material data must also be changed in RSTAB and the design is to be carried out again in order to obtain an exact design.

5.3.3 Window 3.1 Cross-Sections

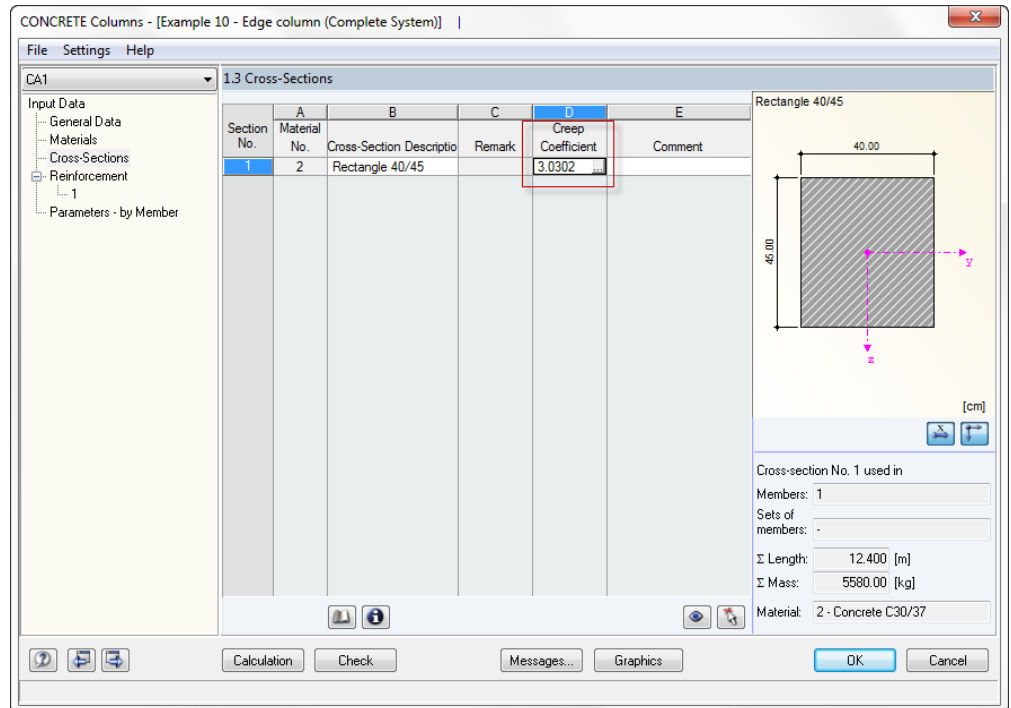


Figure 5.43: Table 1.3 Cross-Sections

In this window, all cross-sections of the members and sets of members previously selected for design in the window 1.1 *General Date* are listed. The settings for every **Creep Coefficient** are also defined here.

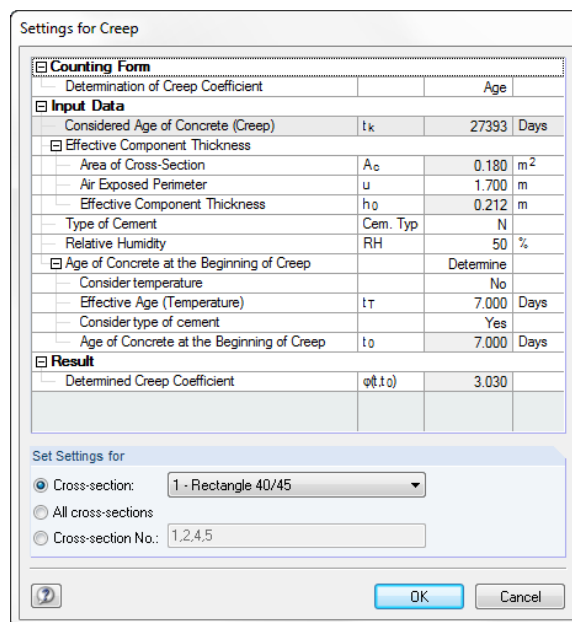


Figure 5.44: Dialog box *Settings for Creep*

The cross-section selected in the list can be modified. To do this, click the button in the lower-left part of the table.

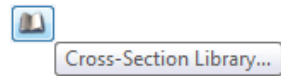


Figure 5.45: Button [Cross-section library]

Click this button to open the RSTAB cross-section library.

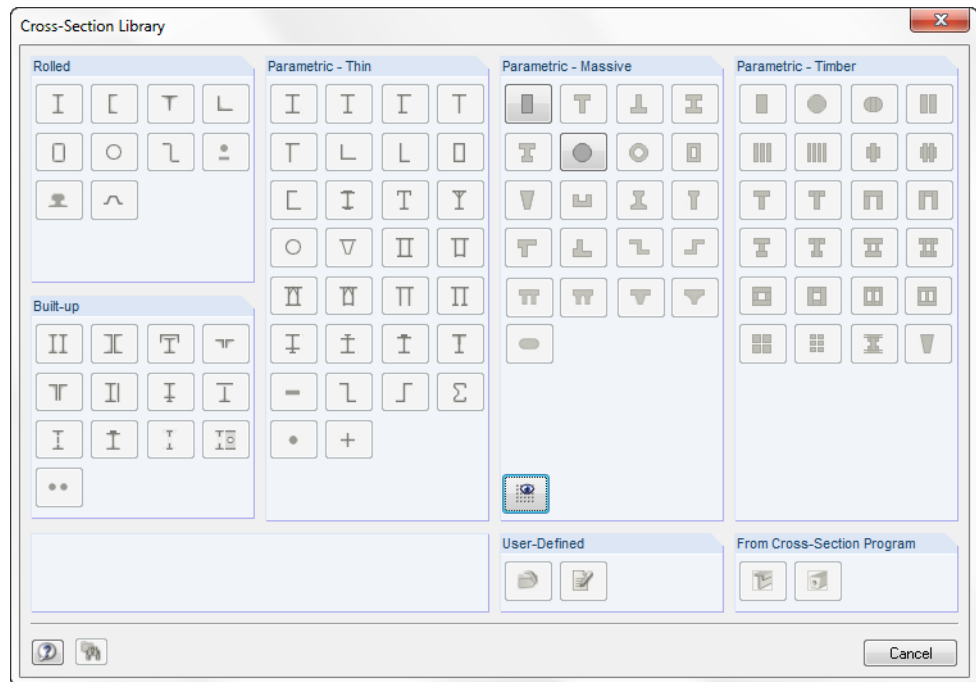


Figure 5.46: Cross-section library

However, only those cross-sections are available here that can be calculated with the module **CONCRETE Columns**. At the point of writing this manual, these are circular and rectangular cross-sections.

There is a graphic depicting the currently selected cross-section on the right side of the window 1.3 *Cross-sections*. Below this graphic, you can see the assignment of this cross-section to certain materials and members.

If you modify a cross-section in this window, this does not automatically result in a change of the cross-sections within RSTAB.

5.3.4 Window 1.4 Reinforcement

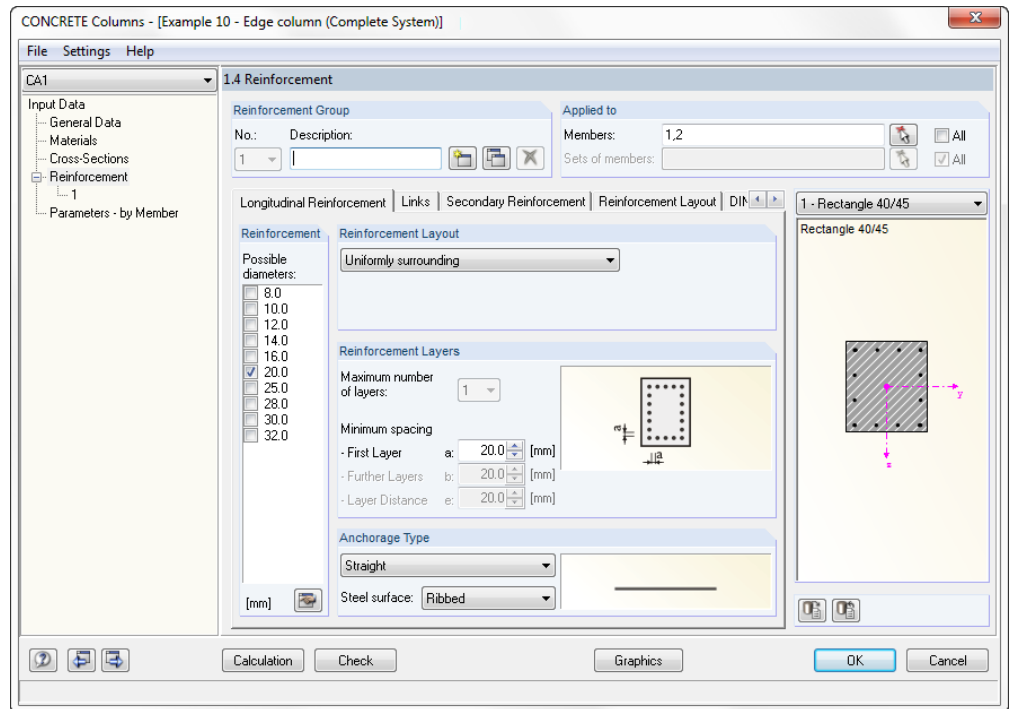


Figure 5.47: Window 1.4 Reinforcement, tab Longitudinal Reinforcement

This window contains the tabs *Longitudinal Reinforcement*, *Links*, *Secondary Reinforcement*, *Reinforcement Layout*, *Standard* and optionally *Fire Resistance*, allowing you to include various specifications for the reinforcement. The specifications depend on the members and sets of members and can often vary. For this reason, it is possible to create different so-called "reinforcement groups," to which you then can assign certain members or sets of members. The specifications of the respective reinforcement groups are applied to the relevant members or sets of members.

Such a reinforcement group is defined in the dialog section *Reinforcement Group* by a number and a user-defined *Description*.

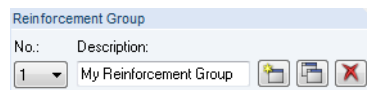


Figure 5.48: Dialog section Reinforcement Group

To the right, in the dialog section *Applied to*, you can specify to which members and sets of members this reinforcement group is to be applied.

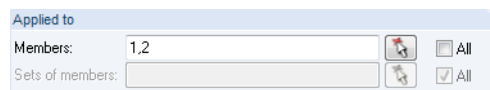


Figure 5.49: Dialog section Applied to

The numbers of the members or sets of members can be typed in the input fields or graphically selected by using the [Select] button. The RSTAB work window appears in which the relevant member or sets of members can be selected by clicking them.

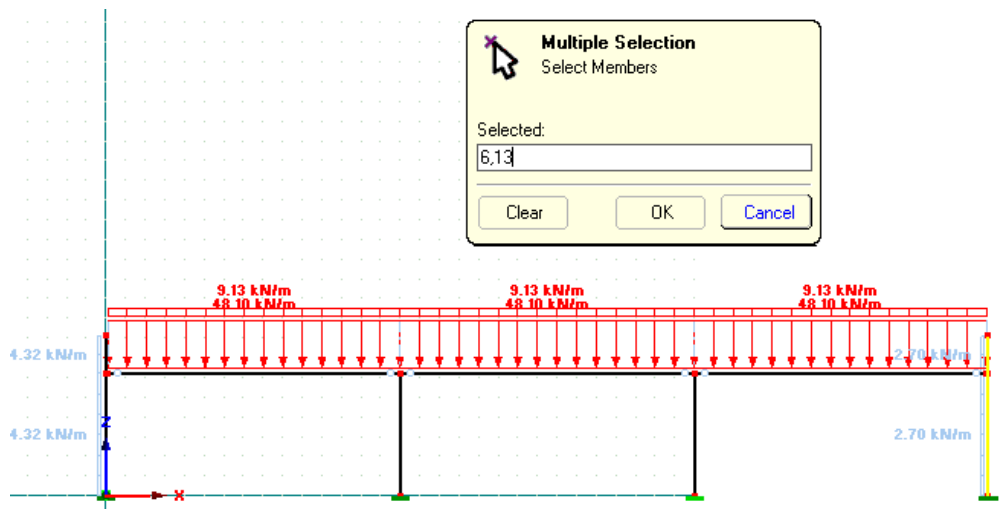


Figure 5.50: Selection of members in the RSTAB work window

A reinforcement group can be applied to all members or sets of members. To do this, select the *All* check box in the dialog section Applied to. However, a restriction follows from this: Since all members or sets of members are already included in the reinforcement group, no other reinforcement group can be defined. This is because there is no more member or set of members to which the reinforcement group could be applied to. You can also recognize this by the fact that the button that is used to create a new reinforcement group is no longer available in the Reinforcement Group dialog section.

If you clear the selection in the check box *All*, ...

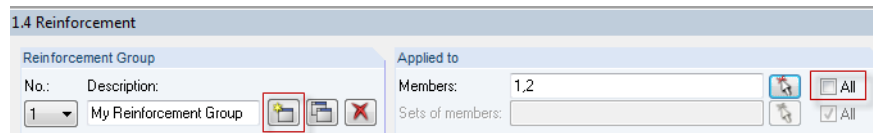


Figure 5.51: Reinforcement group applied to certain members

... the button [New reinforcement group] becomes available.

A reinforcement group that is already defined can be deleted by using the following button.

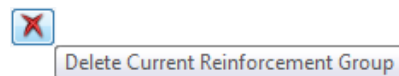


Figure 5.52: Button [Delete reinforcement group]

Notice that no design will be carried out for the members and sets of members that were included in the deleted reinforcement group. If you still want to design it, you must reassign them to a new or an existing reinforcement group. Otherwise, the following error message appears:

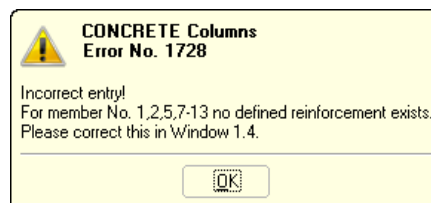


Figure 5.53: Program warning

To modify an existing reinforcement group, you have to select it first. This can be done in two ways:

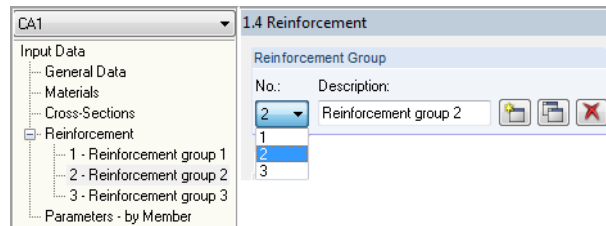


Figure 5.54: Selection of a reinforcement group

In the dialog section *Reinforcement group*, you can select the number of a reinforcement group from the drop-down list. Alternatively, you can set the desired reinforcement group by double-clicking the respective navigator entry.

In the lower part of the table, you can define the current reinforcement group in the six tabs *Longitudinal Reinforcement*, *Links*, *Secondary Reinforcement*, *Reinforcement Layout*, *Standard*, and *Fire Resistance*.

Longitudinal Reinforcement

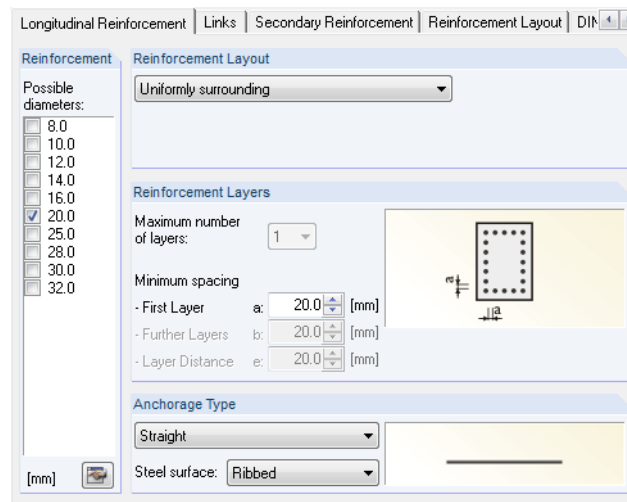


Figure 5.55: Tab *Longitudinal reinforcement*

In the dialog section *Reinforcement*, different reinforcement diameters relevant for the longitudinal reinforcement can be found. To provide the relevant diameter to the program, set the available input fields. The program then determines a solution with the provided possible re-bars only.

You can select from the drop-down list four types of reinforcement layout in the dialog section *Reinforcement Layout*:

- Double-sided - parallel to y-axis
- Double-sided - parallel to z-axis
- In corners
- Uniformly surrounding

To define the *Maximum number of layers*, use the corresponding drop-down list in the dialog section *Reinforcement Layout*. In addition to that, you can specify the arrangement of the distances *a*, *b*, and *e* for the reinforcement layers.

Two drop-down lists in the dialog section *Anchorage Types*, which are important for the determination of the anchorage lengths, conclude this tab. A small graphic to the right illustrates the respective parameters.

Links

In this tab, you set the specifications defining the shear reinforcement.

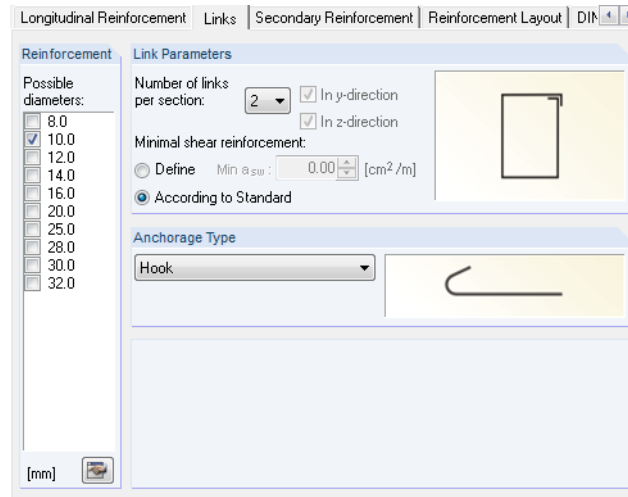


Figure 5.56: Tab *Links*

The possible rebar diameters of the link reinforcement are defined in the dialog section *Reinforcement*, similar to the way it is done in the tab *Longitudinal Reinforcement*.

The number of *Links* can be defined manually according to the standard in the dialog section *Parameters of Links* as well as a minimum shear reinforcement $\text{Min } A_{sw}$. If the statically required shear reinforcement or the minimum shear reinforcement conforming to the standard falls below the value specified in this module, $\text{Min } A_{sw}$ is used as required link reinforcement.

This tab is concluded by two drop-down lists in the dialog section *Anchorage Type* important for the determination of the anchorage lengths. A graphic to the right illustrates the respective anchorage type. You can further modify the geometrical form in window 4.2 *Shear Reinforcement Provided*.

Secondary Reinforcement



Figure 5.57: Tab *Secondary Reinforcement*

In addition to the statically required reinforcement, the intermediate bars are to be arranged along a cross-section side (except for surrounding reinforcement) so that the distance between the bars of the statically required reinforcement does not become too large. The maximum allowable distance is precisely defined in the various standards. By selecting the option *Not considered*, the distance can remain the same. To enter the maximum allowable distance, select the option *Define*.

Thus you can also specify whether to apply the same bar diameter as used for the statically required reinforcement by the program or to enter it manually.

Reinforcement Layout

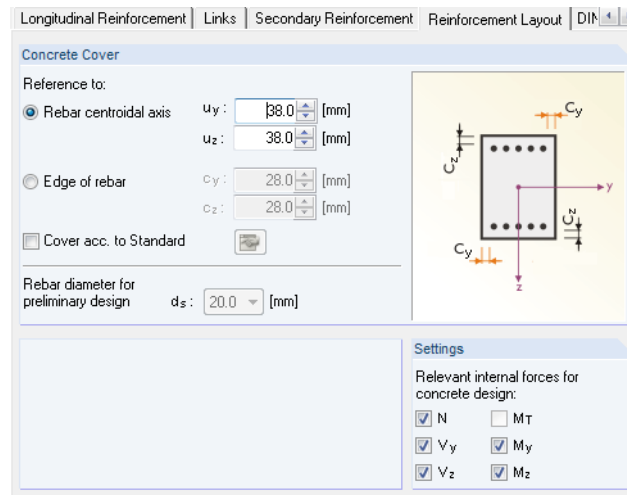


Figure 5.58: Tab *Reinforcement Layout*

In this tab, you can specify the *Concrete Cover* in the direction of the respective axis of the cross-section. Thus, different concrete covers are possible in two directions. These can be specified in the input fields C_y and C_z .

However, only one concrete cover is assigned to a circular cross-section. Depending on the selected option in the dialog section *Concrete Cover*, the covers apply to the *Rebar centroidal axis* or the *Edge of rebar* of the reinforcement.

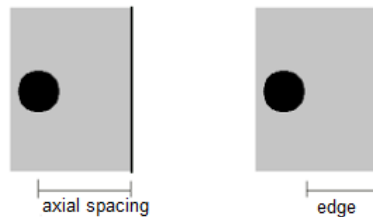


Figure 5.59: Type of concrete cover

To use the nominal concrete cover $c_{nom,long}$ according to 4.4.1.1, select the check box *Cover acc. to Standard*. The following input dialog appears.

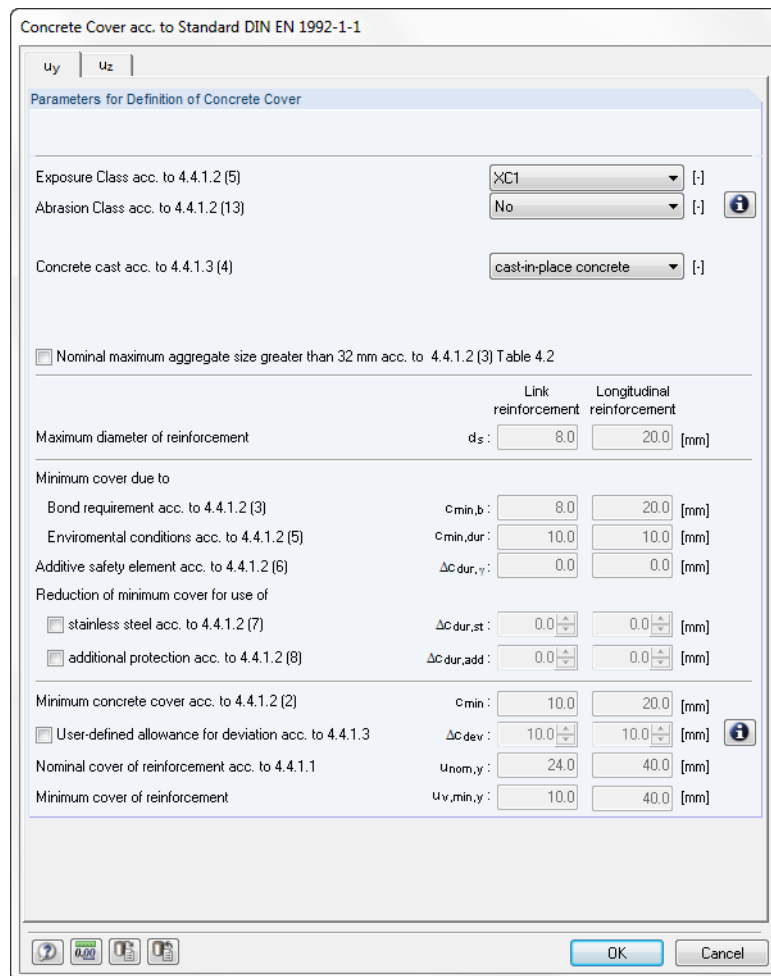


Figure 5.60: Dialog box *Cover acc. to Standard*

This dialog box manages all specifications for the determination of the minimum concrete cover according to the standard. To include the determined concrete covers in the calculation, confirm the input by clicking [OK].

To define the *Rebar diameter for preliminary design*, use the corresponding input field in the tab *Reinforcement Layout*. Thus, the position of reinforcement's centroid t is determined.

The dialog section *Settings* controls which internal forces and moments are considered for the design. You should clear the selection of a component with caution and only as an exception.

Standard

The tab shows the standard selected in window 1.1 *General Data*.

EN 1992-1-1

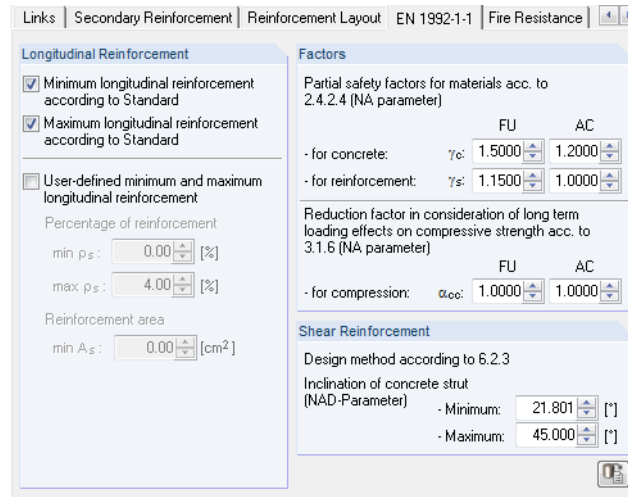


Figure 5.61: Tab *EN 1992-1-1*

In the dialog section *Longitudinal Reinforcement*, you decide whether to use the maximum or minimum longitudinal reinforcement of the respective standard. Alternatively, you can define your own minimum or maximum longitudinal reinforcement.

The minimum reinforcement is specified in clause 9.5.2(2) EN 1992-1-1 as national parameter.

The recommended value is

$$A_{s,min} = \max(0.10 \cdot N_{Ed} / f_{yd}; 0.002 \cdot A_c)$$

The maximum reinforcement is specified in clause 9.5.2(3) EN 1992-1-1 as a national parameter.

The recommended value is

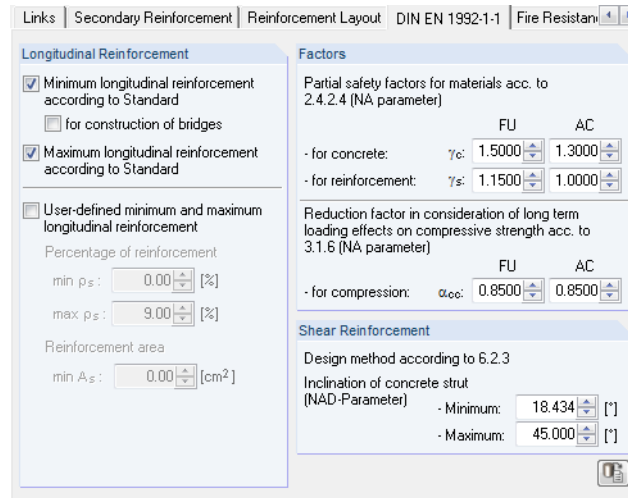
$$A_{s,max} = 0.04 \cdot A_c \text{ (outside overlap locations)}$$

$$A_{s,max} = 0.08 \cdot A_c \text{ (inside overlap locations)}$$

You can define a minimum and maximum for the angle of the compression strut in the dialog section *Shear Reinforcement*. The module determines the intersection set from this user-defined area and the area given by the standard. If the user-defined minimum inclination of the compression strut is greater than the maximum inclination of the compression strut according to standard, this is declared as non-designable.

In the dialog section *Factors*, you can enter the partial safety factors γ for steel and concrete as well as the reduction factor α .

DIN EN 1992-1-1



The screenshot shows the 'DIN EN 1992-1-1' dialog box with the following settings:

- Longitudinal Reinforcement:**
 - Minimum longitudinal reinforcement according to Standard
 - for construction of bridges
 - Maximum longitudinal reinforcement according to Standard
 - User-defined minimum and maximum longitudinal reinforcement
 - Percentage of reinforcement:
 - min ρ_s : 0.00 [%]
 - max ρ_s : 9.00 [%]
 - Reinforcement area:
 - min A_s : 0.00 [cm²]
- Factors:**
 - Partial safety factors for materials acc. to 2.4.2.4 (NA parameter):
 - for concrete: γ_c : FU: 1.5000, AC: 1.3000
 - for reinforcement: γ_s : FU: 1.1500, AC: 1.0000
 - Reduction factor in consideration of long term loading effects on compressive strength acc. to 3.1.6 (NA parameter):
 - for compression: α_{cc} : FU: 0.8500, AC: 0.8500
- Shear Reinforcement:**
 - Design method according to 6.2.3
 - Inclination of concrete strut (NAD-Parameter):
 - Minimum: 18.434 [°]
 - Maximum: 45.000 [°]

Figure 5.62: Tab *DIN EN 1992-1-1*

In the dialog section *Longitudinal Reinforcement*, you decide whether to use the maximum or minimum longitudinal reinforcement of the respective standard. Alternatively, you can define your own minimum or maximum longitudinal reinforcement.

DIN EN 1992-1-1 specifies the following minimum reinforcement for the column to be:

$$A_{s,\min} = 0.15 \cdot N_{ed} / f_{yd} \quad 9.5.2(2)$$

Even in overlaps, the maximum reinforcement may not be greater than:

$$A_{s,\max} = 0.09 \cdot A_c \quad 9.5.2(3)$$

In the dialog section *Shear Reinforcement*, you can define the minimum and maximum angle of the compression strut. The module determines the intersection set from this user-defined area and the area given by the standard. If the user-defined minimum inclination of the compression strut is greater than the maximum inclination of the compression strut according to standard, this is declared as non-designable.

In the dialog section *Factors*, you can define the partial safety factors γ for steel and concrete as well as the reduction factor α_{cc} .

5.3.5 Fire Resistance

EN 1992-1-1

The final tab of this window is only available if you have entered data for the fire protection design in table 1.1 *General Data* (see Figure 5.10, page 73). In this tab, you can define the fire-specific design settings.

In the tab's bottom section, the button [Set default values] is displayed. Use this button to reset the initial values. The fire protection design is performed according to the simplified calculation method described in EN 1992-1-2, 4.2 (see chapter *fire resistance design*, page 38).

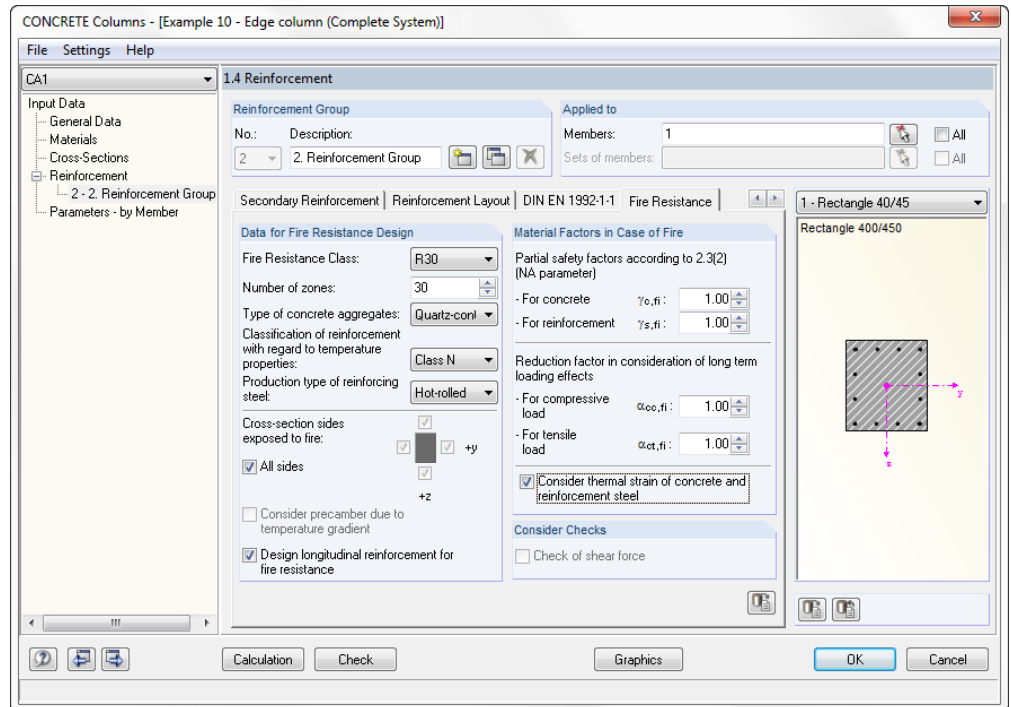


Figure 5.63: Tab *Fire Resistance*

Data for Fire Resistance Design

The following five drop-down lists control the parameters affecting the fire resistance design significantly:

- Fire resistance class (according to EN 1992-1-2, 1.6.1 (1))
- Number of zones (zone method according to EN 1992-1-2, Annex B.2)
- Type of concrete aggregate (cf. Figure 4.38, page 39 and Figure 4.40 page 41)
- Classification of reinforcement (cf. Figure 4.43, page 43)
- Production type of reinforcing steel (cf. Figure 4.44, page 44)

For more theoretical details on these parameters, see the description in chapter *fire resistance design*, page 38ff.

In this dialog section, you also define the *Cross-section sides exposed to fire*. If not *All Sides* are affected by charring, clear the check box. Then the check boxes around the cross-section symbol to the right become active and you can specify the individual sides directly. The directions refer to the local member axes.

Material Factors in Case of Fire

The two input fields in the upper part define the *Partial Safety Factor* for concrete γ_c and for reinforcing steel γ_s which is used for the fire resistance design. The values recommended in EN 1992-1-2, 2.3 (2) are preset.

The *Reduction Factor* α that is used to consider long-term effects on the concrete strength in case of fire can be specified separately for the compressive and the tensile strength. The value of 1.0 recommended in EN 1992-1-1, 3.1.6 is preset in both input fields.

With the option *Consider thermal strain of concrete and reinforcement steel*, it is possible to consider the difference between the strain of the "hot" reinforcement and the regular thermal strain of the concrete cross-section in the form of a pre-compression of the rebar: In case of loading due to temperature, thermal longitudinal strains occur in the concrete and the reinforcing steel varying within the cross-section due to different temperature distributions. The thermal strains cannot arise everywhere freely in the cross-section as they are influenced by the adjacent areas. Generally, it may be assumed that the cross-sections remain plane. As the thermal strain of the reinforcement in the cross-section's edge area is restricted, the reinforcement is pre-shortened. The zone method according to EN 1992-1-2 includes only a calculation of structural components; that is the thermal additional strains in the centroid are not taken into account by the standard. However, according to HOSSER [4], it is required to take into account those thermal strains for calculations according to the second-order analysis. The concrete's thermal strain is calculated across the entire concrete cross-section using the temperature's average value.

Consider Checks

Annex D of EN 1992-1-2 includes a calculation method for the shear design of structural components exposed to fire. This method of calculation is implemented in the add-on module CONCRETE Columns and can be selected separately.

(As this calculation method for the shear and torsional design is not allowed in Germany, this option is not available for the design according to German standards.)

5.3.6 Window 1.5 Column Parameters - by Members

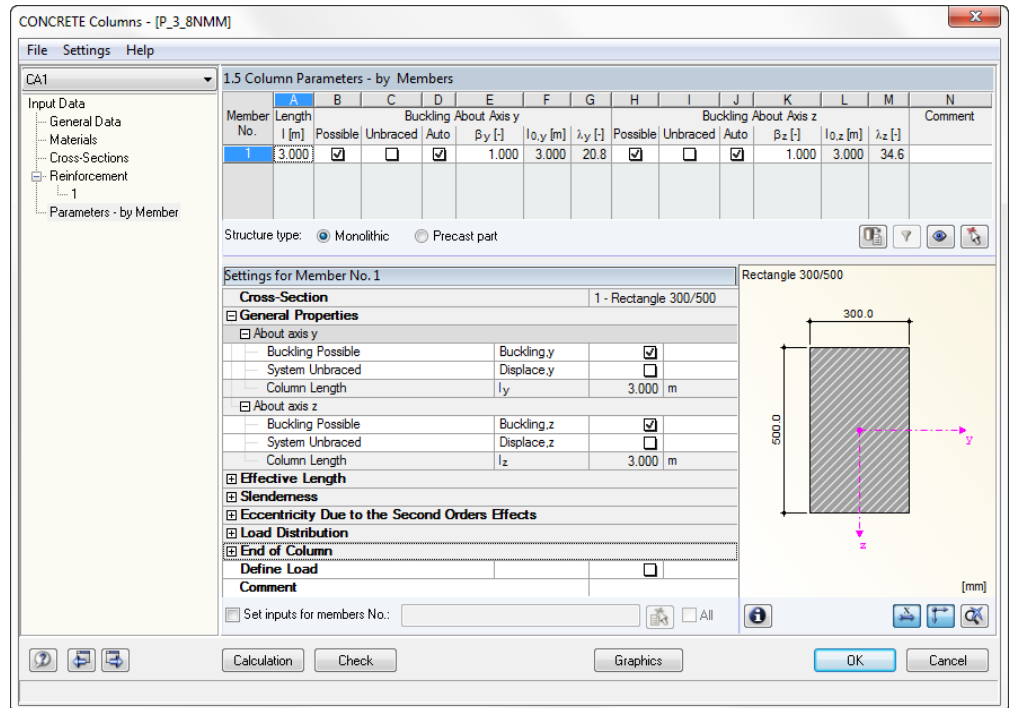


Figure 5.64: Window 1.5 Column Parameters - by Set of Members

This window is intended for input regarding the method based on nominal curvature. There are two variants in this window, depending on whether members or sets of members are specified.

The upper table shows by row the members or sets of members selected in window 1.1 General Data. The length of the considered member of set of members is shown for information in column A. The columns B to J contain various check boxes and input fields used for considering the detailed column parameters.

1.5 Column Parameters - by Members														
Member No.	Length l [m]	Buckling About Axis y			Buckling About Axis z			Comment						
		Possible	Unbraced	Auto	β_y [-]	$l_{0,y}$ [m]	λ_y [-]		Possible	Unbraced	Auto	β_z [-]	$l_{0,z}$ [m]	λ_z [-]
1	3.000	<input checked="" type="checkbox"/>	<input type="checkbox"/>	<input checked="" type="checkbox"/>	1.000	3.000	20.8	<input checked="" type="checkbox"/>	<input type="checkbox"/>	<input checked="" type="checkbox"/>	1.000	3.000	34.6	

Figure 5.65: Upper table of window 1.5 Column Parameters - by Members

The upper table is used for basic settings only. Further specifications resulting from the basic settings can be set in the details table below.

Similarly, further setting options of the upper table are linked with the detail table below. Therefore, only the table's input options regarding the system parameters will be described in the following (columns B to J of the upper table).

1.5 Column Parameters - by Members														
Member No.	Length l [m]	Buckling About Axis y			Buckling About Axis z			Comment						
		Possible	Unbraced	Auto	β_y [-]	$l_{0,y}$ [m]	λ_y [-]		Possible	Unbraced	Auto	β_z [-]	$l_{0,z}$ [m]	λ_z [-]
6	6.200	<input checked="" type="checkbox"/>	<input checked="" type="checkbox"/>	<input type="checkbox"/>	2.100	13.020	100.2	<input type="checkbox"/>	<input type="checkbox"/>	<input type="checkbox"/>	-	-	-	

Figure 5.66: General properties

You can define for the y-axis and z-axis individually whether or not buckling should be possible or whether or not the system is unbraced. The distance of the start and end nodes is assumed for members as system length of the column. For continuous members, this is the distance between the start node of the first member and the end node of the last member in the continuous members. However, you are free to change the system length as you like.

Thus, we have described all input options in the entry *General Properties*.

In connection to this, we will now describe the concept underlying many tables of the program. Some rows contain subordinate rows. This is indicated by a [+] or [-] in the box at the beginning of a row. If you click [+], the subordinated rows are shown. If you click the [-] box, all subordinated rows are hidden. To illustrate this, click such a box.

Thus, if you click the [-] of the entry *General Properties*, you can focus on the next entry *Effective Length*.

To specify the coefficient β , you can open the dialog box with the Euler buckling cases and select the buckling case. Having calculated the buckling length coefficient in RSBUCK, you can also import it to this module.

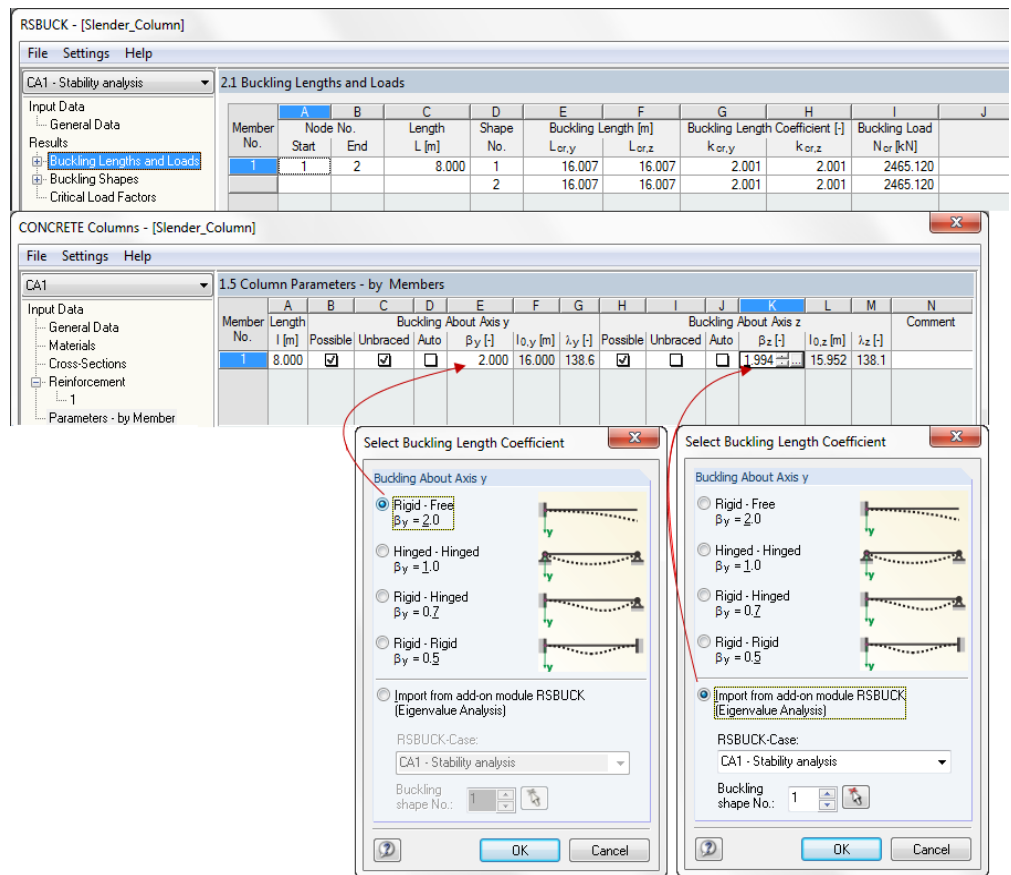


Figure 5.67: Selecting Buckling Length Coefficient

The program offers two further possibilities to determine the effective lengths.

The first possibility is shown in the following figure. You can define the coefficient β for the two member axes directions y and z separately. The program then calculates the effective length.

Settings for Member No. 1			
Cross-Section		1 - Rectangle 300/500	
General Properties			
About axis y			
<input type="checkbox"/>	Buckling Possible	Buckling.y	<input checked="" type="checkbox"/>
<input type="checkbox"/>	System Unbraced	Displace.y	<input type="checkbox"/>
	Column Length	l_y	3,000 m
About axis z			
<input type="checkbox"/>	Buckling Possible	Buckling.z	<input checked="" type="checkbox"/>
<input type="checkbox"/>	System Unbraced	Displace.z	<input type="checkbox"/>
	Column Length	l_z	3,000 m

Figure 5.68: Defining the coefficient β

The second way is to let the program β determine the coefficient. To do this, select the check box *Determine Buckling Length Automatically*. Thus, the details table changes as follows:

Settings for Member No. 1			
Cross-Section		1 - Rectangle 300/500	
General Properties			
Effective Length			
About axis y			
<input checked="" type="checkbox"/>	Determine Buckling Length Automatically:	Detm- β	<input checked="" type="checkbox"/>
<input type="checkbox"/>	k_A - Stiffness at Column Support		
<input type="checkbox"/>	k_B - Stiffness at Column Support		
<input type="checkbox"/>	Determined Buckling Length Coefficient	β_y	1,000
	Effective Length	$l_{0,y}$	3,000 m
About axis z			
<input checked="" type="checkbox"/>	Determine Buckling Length Automatically:	Detm- β	<input checked="" type="checkbox"/>
<input type="checkbox"/>	k_A - Stiffness at Column Support		
<input type="checkbox"/>	k_B - Stiffness at Column Support		
<input type="checkbox"/>	Determined Buckling Length Coefficient	β_z	1,000
	Effective Length	$l_{0,z}$	3,000 m

Figure 5.69: Determining coefficient β

The determination of the coefficient β is described in the following example.

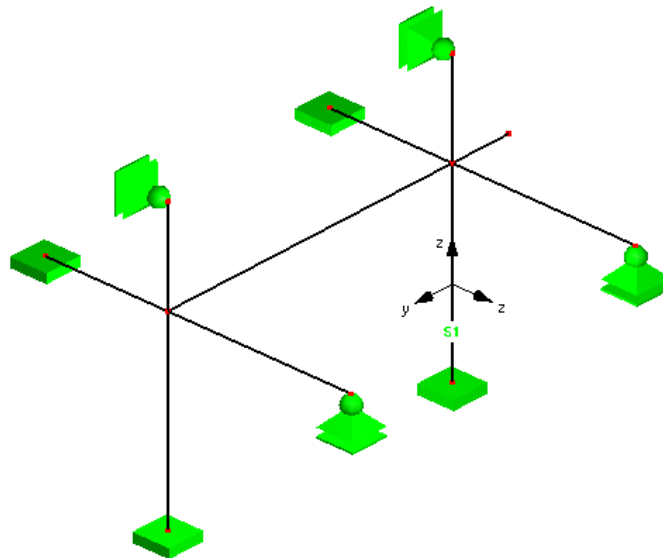


Figure 5.70: Column model

We analyze the column "C1." The figure above shows the yz member axis system. Only rectangular 30/40 cross-sections are used in the system.

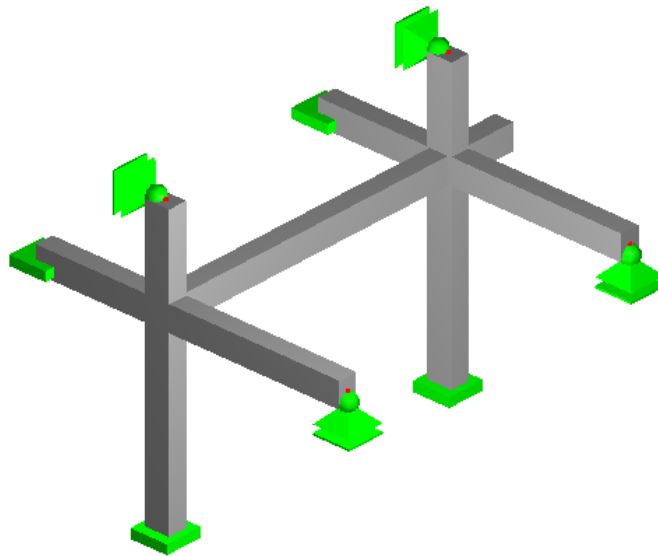


Figure 5.71: Rendered depiction of the column

In window 1.5 *Column Parameters*, the following can be specified for the system:

Settings for Member No. 1			
Cross-Section		1 - Rectangle 300/500	
General Properties			
<input type="checkbox"/> About axis y			
<input type="checkbox"/> Buckling Possible	Buckling.y	<input checked="" type="checkbox"/>	
<input type="checkbox"/> System Unbraced	Displace.y	<input type="checkbox"/>	
Column Length	I_y	3.000	m
<input type="checkbox"/> About axis z			
<input type="checkbox"/> Buckling Possible	Buckling.z	<input checked="" type="checkbox"/>	
<input type="checkbox"/> System Unbraced	Displace.z	<input type="checkbox"/>	
Column Length	I_z	3.000	m

Figure 5.72: Specifications of the system

For the determination of the Effective length *about the y-axis*, select the check box *Detm-β*.

Effective Length			
<input type="checkbox"/> About axis y			
<input type="checkbox"/> Determine Buckling Length Automatic:	Detm-β	<input checked="" type="checkbox"/>	

Figure 5.73: Specifications for the determination of the coefficient β

The entries k_A and k_B appear. In these entries, you can specify the beam and column connecting at the column start and column end. If you look at the next lower levels of k_A and k_B , you can see that there are input possibilities to select the connecting beams and columns.

Effective Length			
<input type="checkbox"/> About axis y			
<input type="checkbox"/> Determine Buckling Length Automatic:	Detm-β	<input checked="" type="checkbox"/>	
k_A - Stiffness at Column Support			
<input type="checkbox"/> Enter the value manually		<input type="checkbox"/>	
<input type="checkbox"/> Connecting Column		<input checked="" type="checkbox"/>	
Column			
<input type="checkbox"/> Define	Def-Member	<input type="checkbox"/>	
<input type="checkbox"/> Member	No.		[...]
<input type="checkbox"/> Column Length	I_{col}	0.000	m
<input type="checkbox"/> 2nd Moment of Area	I_y	0.0	mm ⁴
<input type="checkbox"/> E-modulus	E	0.00	N/mm ²
<input type="checkbox"/> Number of Members		1	
1. Beam			
<input type="checkbox"/> Stiffness at Column Support	k	∞	

Figure 5.74: Input under k_A

If you click, for example, in the cell intended for the entry of member numbers of the column, the [...] button appears. Click this button to go to the RSTAB work window where you can select

the relevant member. Thus, system length, moment of inertia, and modulus of elasticity are transferred automatically to the next rows.

Effective Length			
About axis y			
Determine Buckling Length Automatic:		Detm- β	<input checked="" type="checkbox"/>
k _A - Stiffness at Column Support			
Enter the value manually			<input type="checkbox"/>
Connecting Column			<input checked="" type="checkbox"/>
Column			
Define		Def-Member	<input type="checkbox"/>
Member		No.	4
Column Length		l _{col}	1.500 m
2nd Moment of Area		I _y	90000.0 cm ⁴
E-modulus		E	32000.00 N/mm ²
Number of Members			2
1. Beam			
Define		Def-Member	<input type="checkbox"/>
Member		No.	3
Girder Length		l _b	2.000 m
2nd Moment of Area		I _y	90000.0 cm ⁴
E-modulus		E	32000.00 N/mm ²
User-defined Coefficient of Restraint		def. α	<input type="checkbox"/>
2. Beam			
Define		Def-Member	<input type="checkbox"/>
Member		No.	2
Girder Length		l _b	3.000 m
2nd Moment of Area		I _y	90000.0 cm ⁴
E-modulus		E	32000.00 N/mm ²
User-defined Coefficient of Restraint		def. α	<input type="checkbox"/>
Stiffness at Column Support		k	1.500
k _B - Stiffness at Column Support			
Enter the value manually			<input checked="" type="checkbox"/>
Connecting Column			0.000
Determined Buckling Length Coefficient		β_y	0.660
Effective Length		l _{0,y}	1.980 m

Figure 5.75: Determining the effective length

This input corresponds with the properties of the system members.

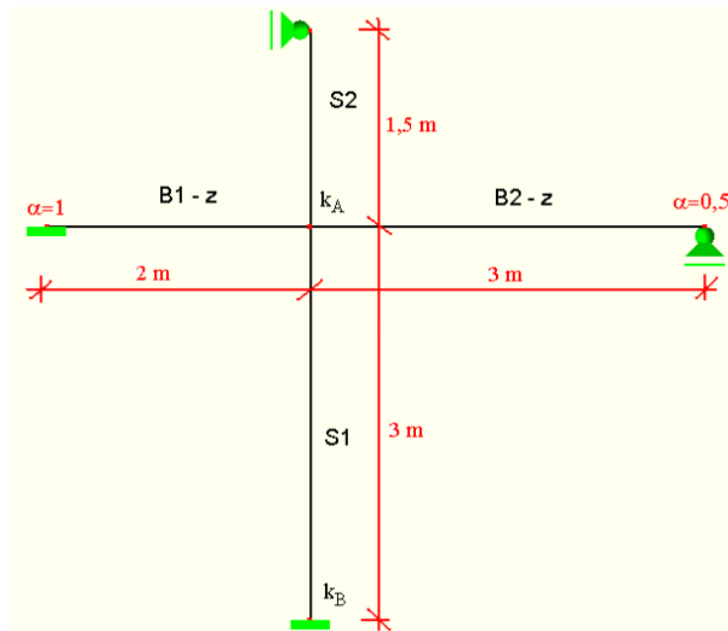


Figure 5.76: System about the y-axis

Thus, the program can determine k_A. It is additionally checked by manual calculation.

$$k_A = \frac{\sum E_{cm} \cdot I_{col} / I_{col}}{\sum E_{cm} \cdot \alpha \cdot I_b / I_b} = \frac{E_{cm} \cdot I_{S1} / I_{col,S1} + E_{cm} \cdot I_{S2} / I_{col,S2}}{E_{cm} \cdot \alpha_1 \cdot I_{B1-z} / I_{B1-z} + E_{cm} \cdot \alpha_2 \cdot I_{B2-z} / I_{B2-z}}$$

$$= \frac{32000 \cdot 90000 / 3 + 32000 \cdot 90000 / 1,5}{32000 \cdot 1 \cdot 90000 \cdot / 2 + 32000 \cdot 0,5 \cdot 90000 \cdot / 3} = 1.5$$

where

$\alpha_1 = 1.0$ the farther end is rigidly restrained

$\alpha_2 = 0.5$ the farther end is supported as free to rotate

There is no restraint at the support of column C1. Therefore, the program uses the option of defining the value of k_B , and then sets it to zero.

Effective Length			
About axis y			
Determine Buckling Length Automatic: Detm- β		<input checked="" type="checkbox"/>	
k _A - Stiffness at Column Support			
k _B - Stiffness at Column Support			
Enter the value manually		<input checked="" type="checkbox"/>	
Connecting Column	k _B	0.000	
Determined Buckling Length Coefficient		0.660	
Ersatzlänge	l _{0,y}	1.980	m
About axis z			

Figure 5.77: Defining the value for k_B

In the figure above, you can see the coefficient $\beta_y = 0.66$ determined by the from the values $k_A = 1.5$ and $k_B = 0.0$.

This is checked by means of the nomogram for braced systems.

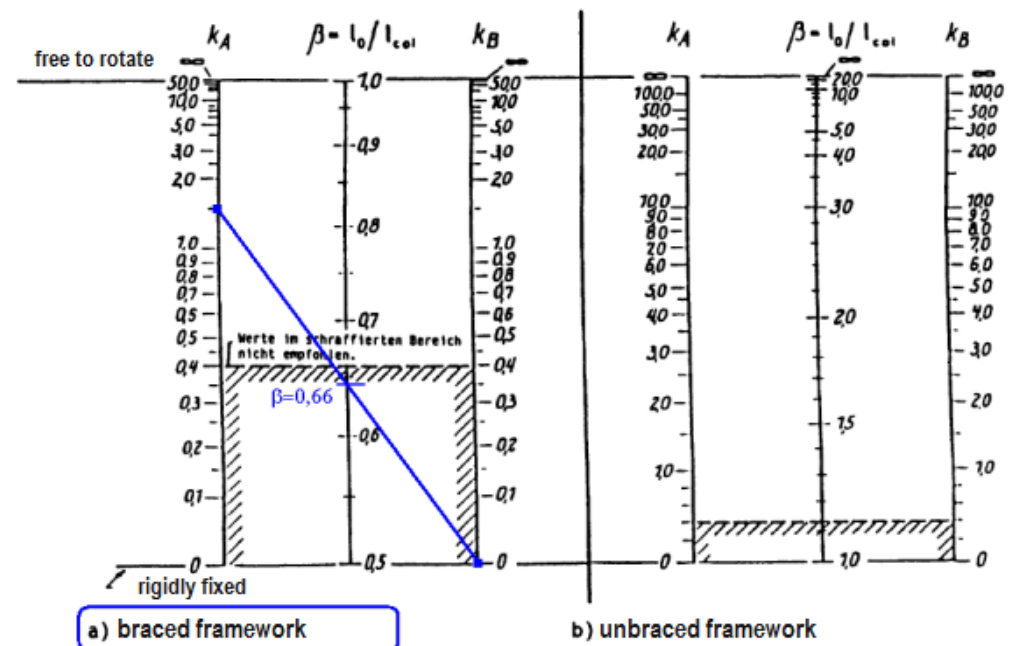


Figure 5.78: Graphical determination of β_y

$$l_{col,y} = 3 \text{ m}$$

$$l_{0,y} = l_{col,y} \cdot \beta_y = 3 \cdot 0.66 = 1.98 \text{ m}$$

In addition, the effective length $l_{0,z}$ is determined about the z-axis.

About axis y		
Determine Buckling Length Automatic	Detm-β	<input checked="" type="checkbox"/>
k _A - Stiffness at Column Support		
Enter the value manually		<input type="checkbox"/>
Connecting Column		<input checked="" type="checkbox"/>
Column		
Define	Def-Member	<input type="checkbox"/>
Member	No.	4
Column Length	l _{col}	1.500 m
2nd Moment of Area	I _y	160000.0 mm ⁴
E-modulus	E	32000.00 N/mm ²
Number of Members		2
1. Beam		
Define	Def-Member	<input type="checkbox"/>
Member	No.	10
Girder Length	l _b	5.000 m
2nd Moment of Area	I _y	160000.0 mm ⁴
E-modulus	E	32000.00 N/mm ²
User-defined Coefficient of Restraint		
def. α		<input type="checkbox"/>
Coefficient of Restraint	α	Tough
Stiffness at Column Support	k	
2. Beam		
Define	Def-Member	<input type="checkbox"/>
Member	No.	12
Girder Length	l _b	1.000 m
2nd Moment of Area	I _y	160000.0 mm ⁴
E-modulus	E	32000.00 N/mm ²
User-defined Coefficient of Restraint		
def. α		<input type="checkbox"/>
Coefficient of Restraint	α	Free
Stiffness at Column Support	k	5.000
k _B - Stiffness at Column Support		
Determined Buckling Length Coefficient	β _y	1.490
Effective Length	l _{0,y}	4.470 m

Figure 5.79: Determination of the effective length l_{0z}

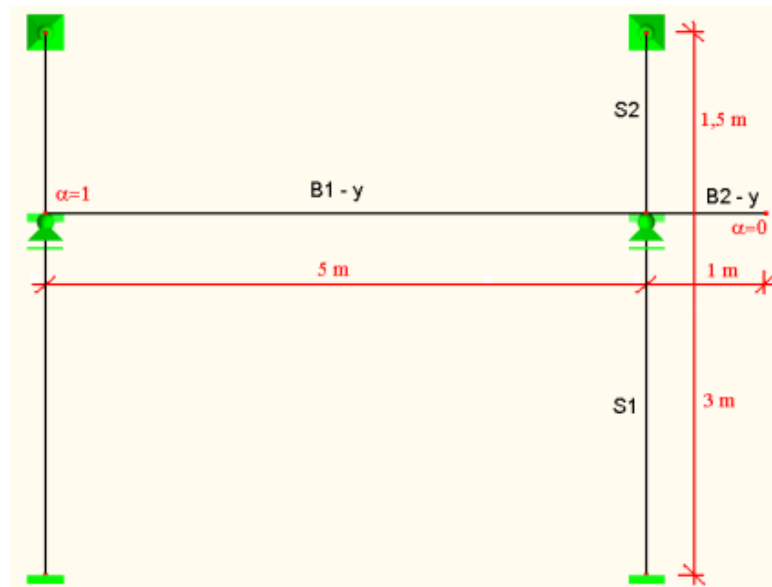


Figure 5.80: System about z-axis

$$k_A = \frac{\sum E_{cm} \cdot I_{col} / l_{col}}{\sum E_{cm} \cdot \alpha \cdot I_b / l_b} = \frac{E_{cm} \cdot I_{S1} / l_{col,S1} + E_{cm} \cdot I_{S2} / l_{col,S2}}{E_{cm} \cdot \alpha_1 \cdot I_{B1-y} / l_{B1-y} + E_{cm} \cdot \alpha_2 \cdot I_{B2-y} / l_{B2-y}} =$$

$$= \frac{32000 \cdot 90000 / 3 + 32000 \cdot 90000 / 1.5}{32000 \cdot 1 \cdot 90000 / 5 + 32000 \cdot 0 \cdot 90000 / 1} = 5$$

where

α₁ = 1.0 the end farther away is rigidly restrained

α₂ = 0 Cantilever beam

k_B = 0

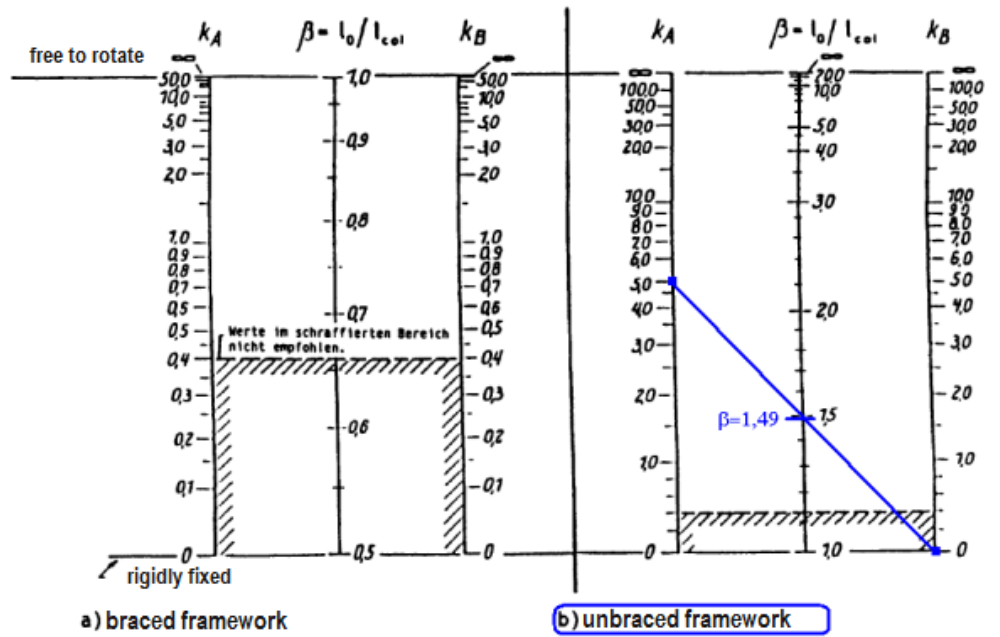


Figure 5.81: Graphical determination of β_z

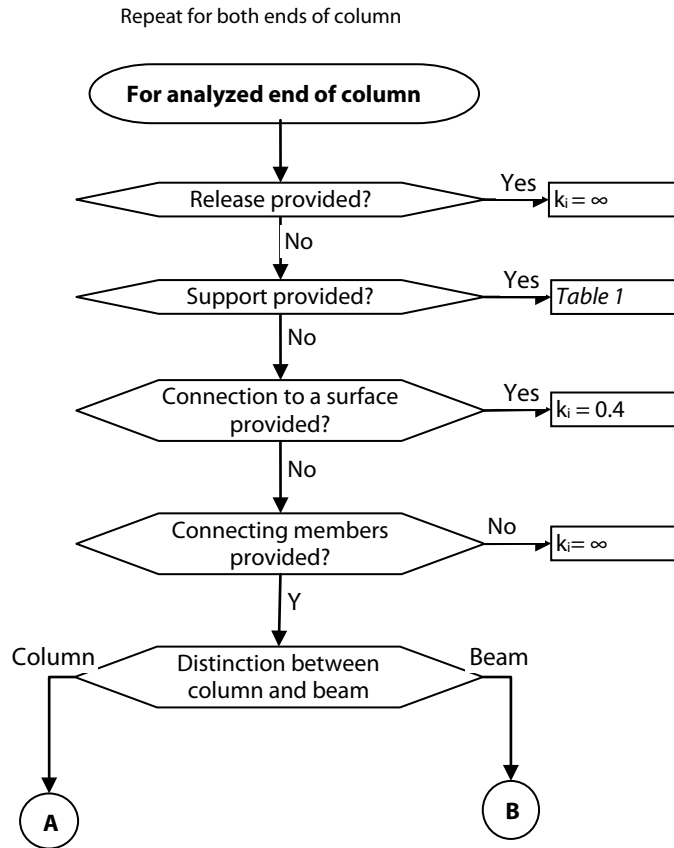
$$l_{col,y} = 3 \text{ m}$$

$$l_{0,z} = l_{col,z} \cdot \beta_z = 3 \cdot 1.49 = 4.47 \text{ m}$$

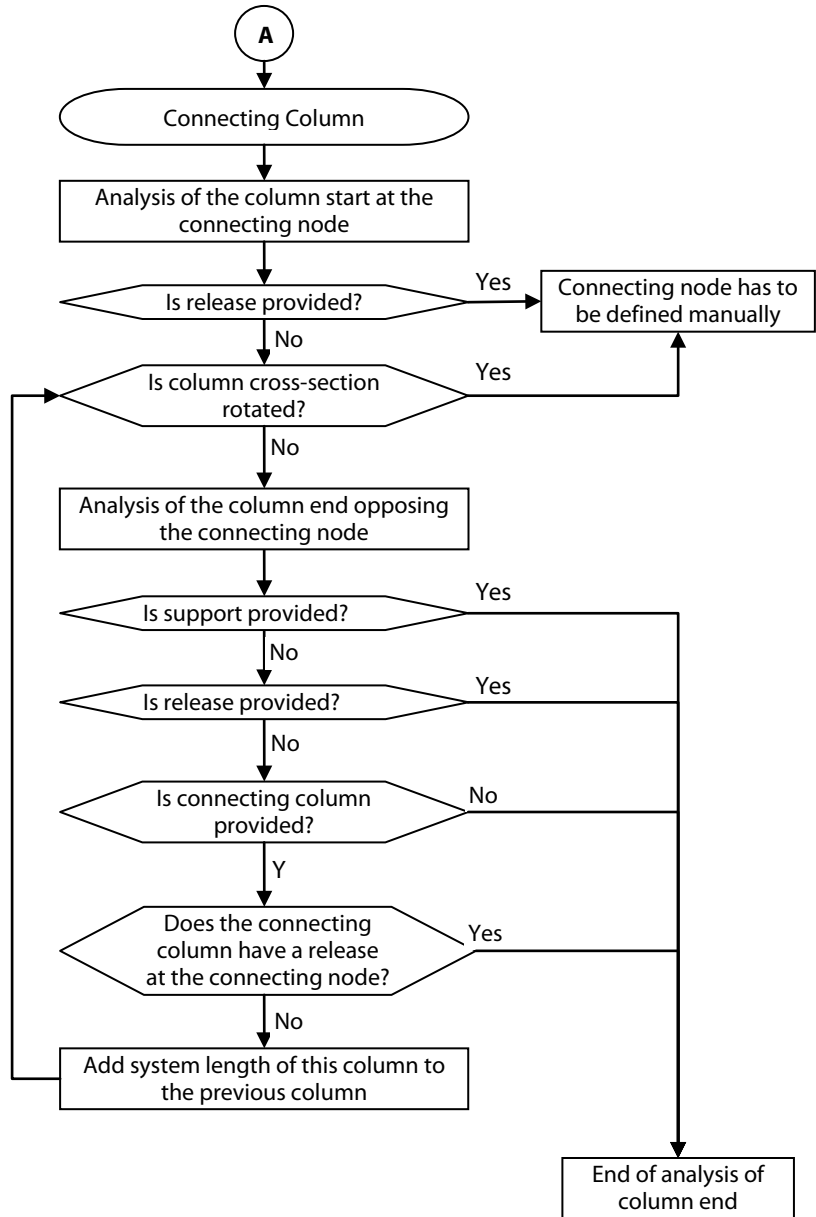
We next describe how the structural system is considered in the selection of the column and beam at a node of the column under consideration. The node stiffnesses in the axis direction y and z of the local member system of the column are calculated for each vertical member of the material type "concrete." The support or connecting members are recognized automatically if they have the same direction as the axes of the local member coordinate system. For information on further conditions, see the program flowchart.

Part 1:

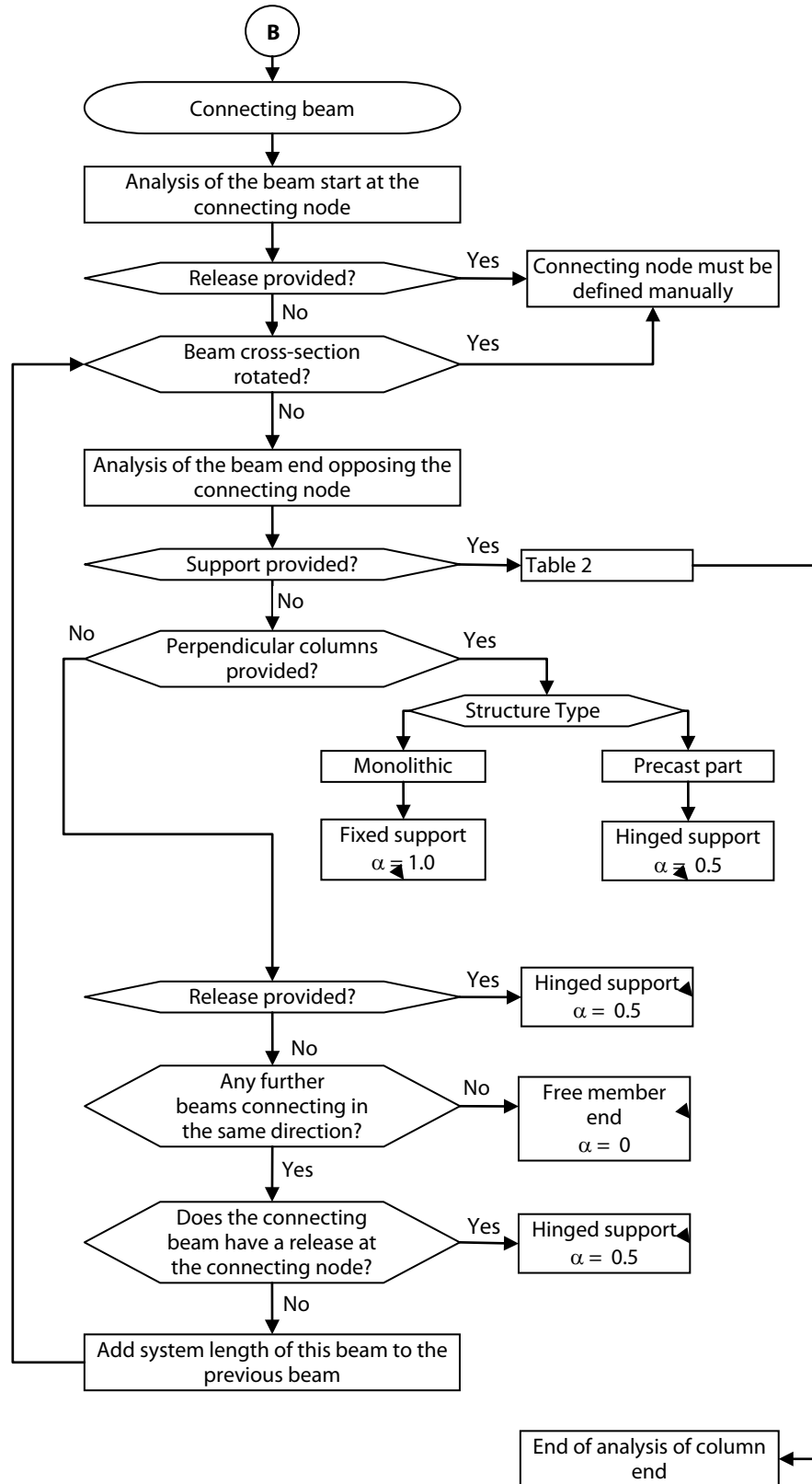
Main structure for determination of end node stiffness



Part 2:
Analysis of connecting columns



Part 3:
Analysis of the connecting beam



In the next two tables, you can see how the supports are classified according to their support type. This classification is required for the model column analysis.

Table 1: Support properties for the determination of k_A or k_B

Supports:	Fixed in z-axis	Fixed in y-axis	Fixed in y- axis and z-axis	Release in z-axis	Release in y-axis	Release in y-axis and z-axis
Ux	any	any	any	any	any	any
Uy	any	any	any	any	any	any
Uz	any	any	any	any	any	any
φ_x	any	x	x	any	o	o
φ_y	x	any	x	o	any	o
φ_z	any	any	any	any	any	any
λ or κ_{KB}	0.4	0.4	0.4	∞	∞	∞

x=rigid or supported by spring
o=not supported

Table 2: Support properties to determine α

Supports:	Rigid in z-axis	Rigid in y-axis	Rigid in y-axis and z-axis	Support in z-axis	Support in y-axis	Support in y- and z-axis	Free
Ux	any	any	any	any	any	any	any
Uy	any	any	any	any	any	any	any
Uz	x	x	x	x	x	x	o
φ_x	any	x	x	any	o	o	any
φ_y	x	any	x	o	any	o	any
φ_z	any	any	any	any	any	any	any
α	1.0	1.0	1.0	0.5	0.5	0.5	0

x= rigid or supported by spring
o=not supported

It might happen that the effective length cannot be automatically determined for some columns. Such columns either do not consist of concrete or have a free end without connecting structure or support.

If several members connect to the column end, the program always searches for the one member of the connecting members that has the smallest modulus of elasticity and the smallest moment of inertia in order to be on the safe side.

You must decide for yourself whether a column belongs to a braced or an unbraced system. The presetting is braced.

Below the table containing the list of the analyzed columns, you can choose between monolithic and precast systems.

Structure type: Monolithic Precast part

Figure 5.82: Selection of the structure type

This option significantly influences the stiffnesses at the end node of the connecting members. If you choose the *Monolithic* structure, the stiffness of the connections is set to "fixed." If you choose the structure consisting of *precast parts*, the stiffness of the connections will be set to "hinged." Therefore, it is important to determine if all releases have already been considered and modeled in the structure. The results are on the safe side in precast structural systems.

On the right side, there are the buttons [Default values], [Filter], [Jump to graphic], and [Select member in graphic].

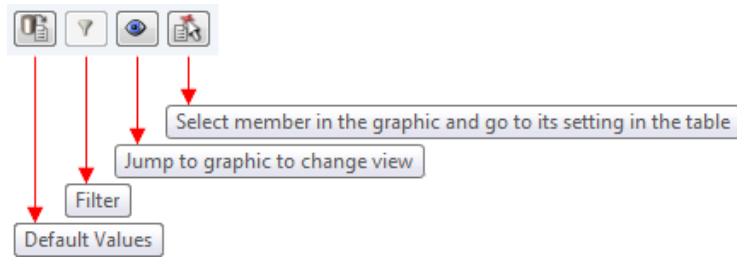


Figure 5.83: Buttons

To set the default setting corresponding with the model in RSTAB, click [Default values].

To view all columns yet to be defined, click [Filter]. Such columns are displayed in red. Stiffnesses that are not completely specified can be manually entered in the table below.

To jump to the graphic, thus changing the view, click [Jump to graphic]. To select the member in the graphic for the settings, click [Select member in graphic].

The minimum node stiffnesses k_A or k_B are set according to the standard's recommendation to 0.4 in the case of automatic determination of β . In case of manual input, you can also enter values smaller than 0.4.

Similarly, the coefficient β is set to 2 in unbraced systems and to 1 in braced systems. In case of manual input, you can also enter smaller values.

The next entry *Slenderness* shows in its subordinate rows the slendernesses λ_y and λ_z that were determined separately in both directions.

Slenderness			
About axis y			
Slenderness	λ_y		76.705
Limiting Slenderness			
Determine Factor A_y			
Determined Factor A_y	Factor A_y		0.700
Determine Factor B_y			
Determined Factor B_y	Factor B_y		1.100
Determine Factor C_y			
Determined Factor C_y	Factor C_y		0.700
About axis z			
Slenderness	λ_z		107.387
Limiting Slenderness			
Determine Factor A_z			
Determined Factor A_z	Factor A_z		0.700
Determine Factor B_z			
Determined Factor B_z	Factor B_z		1.100
Determine Factor C_z			
Determined Factor C_z	Factor C_z		0.700

Figure 5.84: Display of the determined slenderness

5.4 Details

The [Details] button enables further calculation options. This button is available in all input windows if you design according to EN 1992-1-1 or SIA 262.

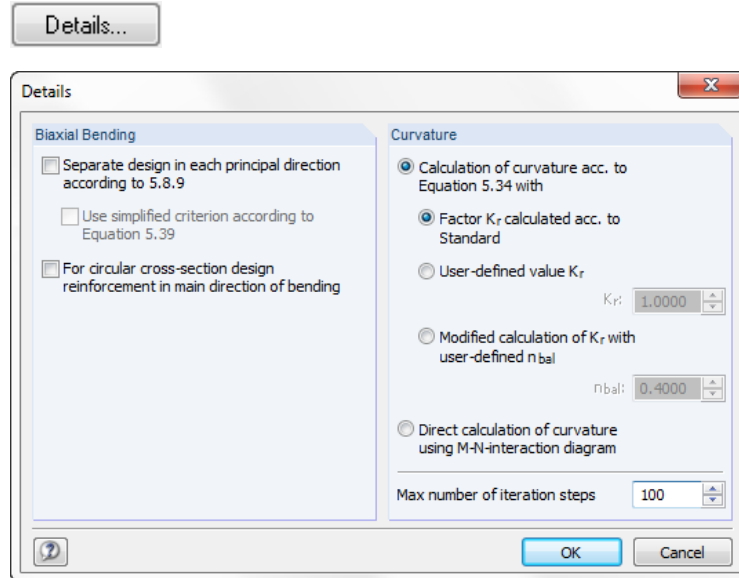


Figure 5.85: Dialog box *Details*

Biaxial bending

- Separate design in each principal direction according to 5.8.9

A biaxially loaded cross-section (M_y/M_z) can be calculated according to a simplified method for each principal axis direction according to clause 5.8.9. In this case we check whether the conditions of the expressions 5.38a and 5.38b have been satisfied.

$$\frac{\lambda_y}{\lambda_z} \leq 2,0 \text{ and } \frac{\lambda_z}{\lambda_y} \leq 2,0 \quad (5.38a)$$

and

$$\frac{e_y / h_{eq}}{e_z / b_{eq}} \leq 0,2 \text{ or } \frac{e_z / b_{eq}}{e_y / h_{eq}} \leq 0,2 \quad (5.38b)$$

If these conditions are met, the program performs the separate design in each direction of the principal axes with the total reinforcement in the cross-section.

- Separate design in each principal direction according to 5.8.9
- Use simplified criterion according to Equation 5.39

If the expressions according to 5.38 are not met, the Standard allows for the alternative design according to expression 5.39:

$$\left(\frac{M_{Edz}}{M_{Rdz}} \right)^a + \left(\frac{M_{Edy}}{M_{Rdy}} \right)^a \leq 1,0 \quad (5.39)$$

In general, the following is true: If the expressions according to 5.38 or 5.39 are not met, the program performs a standard design taking into account the two applied moments M_y/M_z .

Curvature

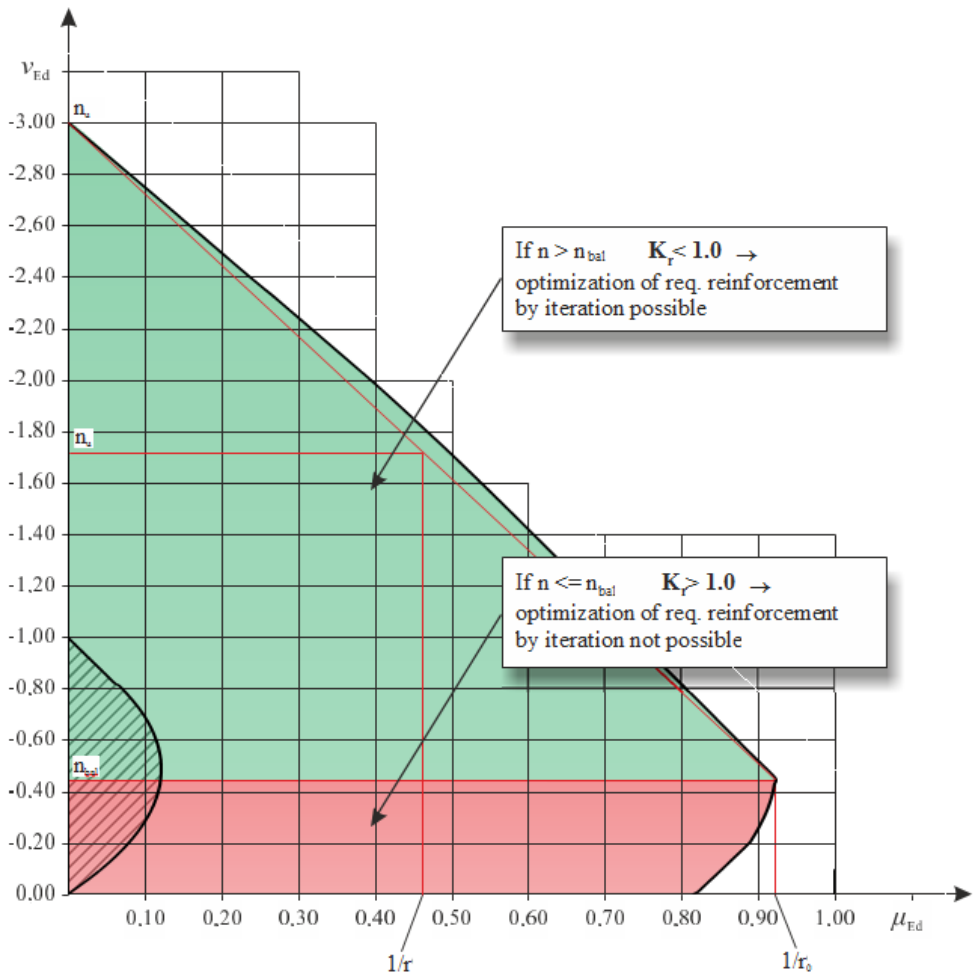
- Calculation of curvature acc. to Equation 5.34 with
- Factor K_r calculated acc. to Standard

The approximated determination of the curvature $1/r$ is to be performed with the expression 5.34 according to the method based on nominal curvature (default setting). As the curvature of the cross-section changes depending on the inserted reinforcement, the program automatically determines K_r iteratively. In the first step, the reinforcement is unknown. Therefore, K_r is assumed as 1.0 in order to be on the safe side. Since the current curvature can never be greater than the curvature for a maximum bending moment, K_r is always less or equal 1.0.

An optimization of the value K_r and thus the reduction of the curvature is only possible when the related axial force n is greater than n_{bal} (reference axial force for maximum bending resistance). If the applied reference axial force is less than n_{bal} (this area is red in the following figure), K_r is 1.0 and the iteration is stopped after the first step.

If the applied related axial force is greater than the related axial force for maximum bending resistance, the optimization can be carried out by iteration. In particular, a significant reduction of the curvature, and thus an optimization of the longitudinal reinforcement to be applied, is possible in the case of structural components subjected to a great axial force.

The following figure shows the simplified method for the calculation of curvature.



User-defined value K_r

K_r : 1.0000

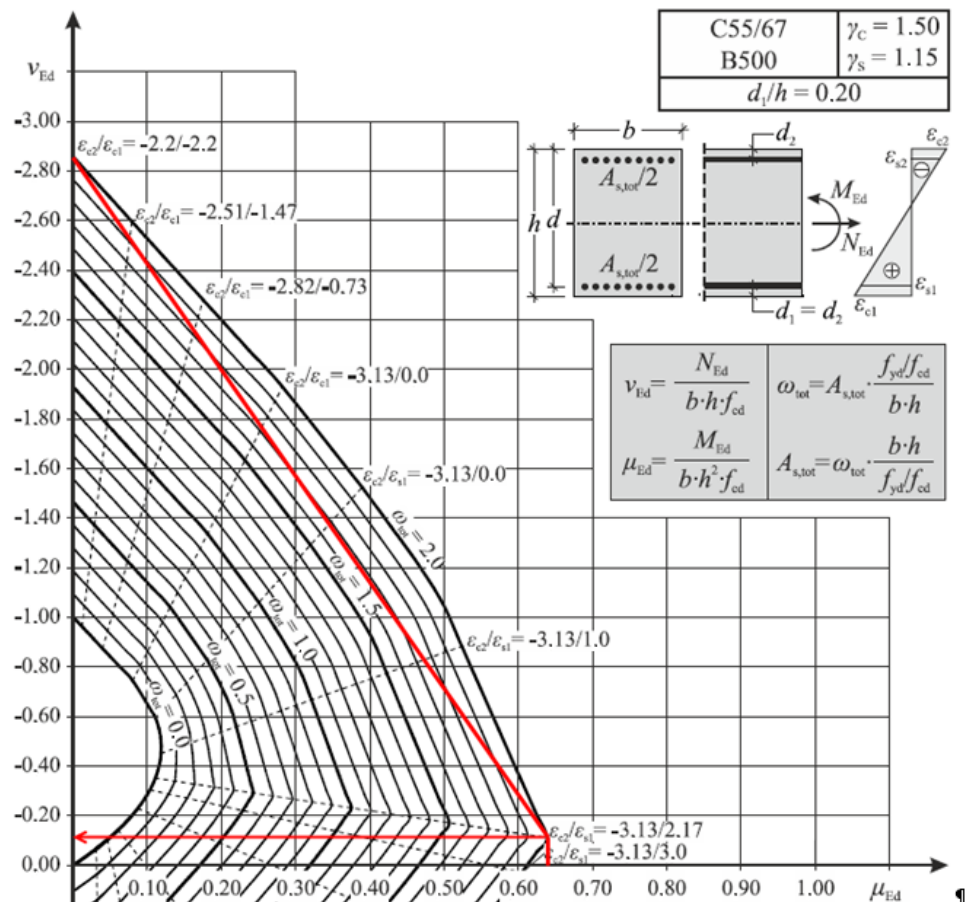
If results from other program or a manual calculation are available, in which the value K_r was assumed simplifying as 1.0, K_r can be set to 1.0. Thus the iteration is deactivated. The results from CONCRETE Columns thus become comparable.

Modified calculation of K_r with user-defined n_{bal}

n_{bal} : 0.4000

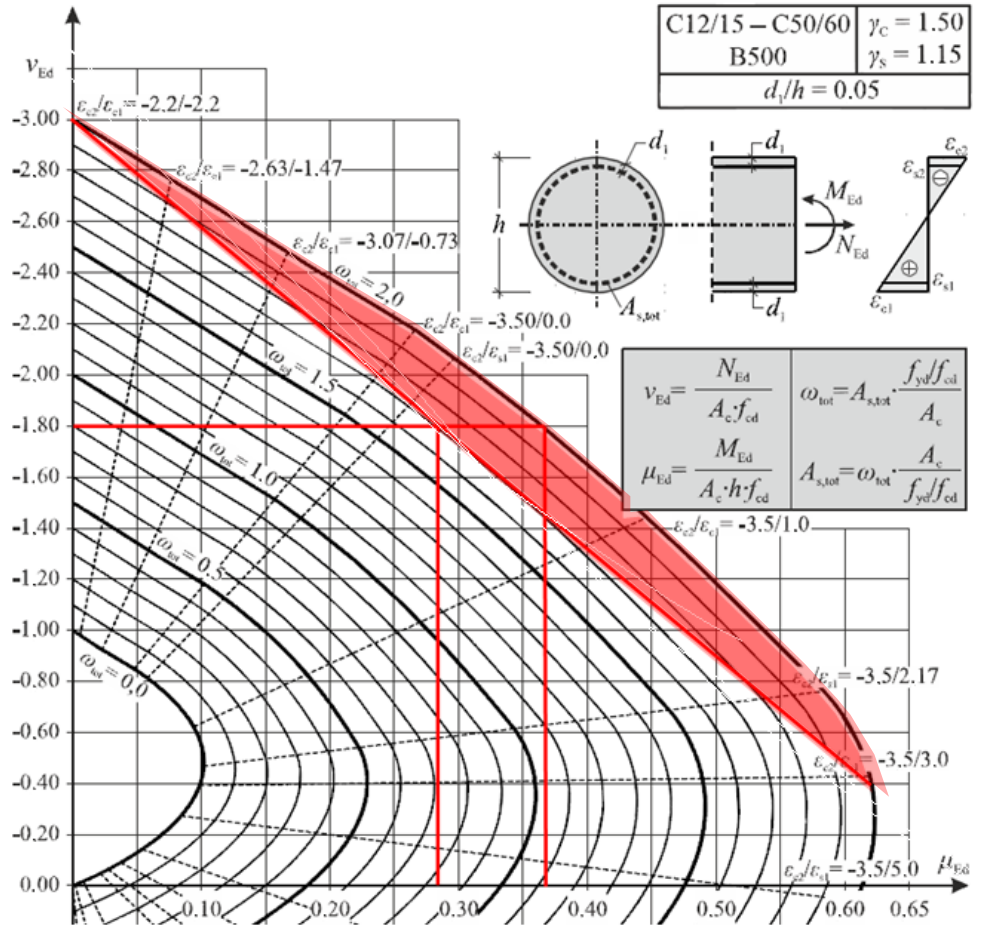
The modified calculation of K_r allows for a user-defined specification of the related reference axial force n_{bal} . According to clause 5.8.8.3(4), the value 0.4 may be used for n_{bal} . This value applies for standard concrete (C12/15 to C50/60) assuming a biaxially symmetrically reinforced rectangular cross-section with a d_1/h -ratio between 0.05 and 0.20. Other strength classes, cross-section geometries, or d_1/h ratios show that the specified value for $n_{bal} = 0.4$ is not appropriate and can lead to uneconomical results. If the cross-section shape, the d_1/h -ratio, and/or the concrete strength class do not meet the conditions, it is recommended to use the modified calculation of K_r and to define the value n_{bal} manually.

The following graphic shows the constellation where $n_{bal} = 0.4$ is not appropriate.



Direct calculation of curvature using M-N-interaction diagram

The last possibility for the determination of the curvature is the most accurate option. However, it is not specified in the Standard. In this case, a direct calculation of the curvature is performed instead of the linear interpolation. This direct calculation takes into account the “belly-shaped” form of the interaction of axial force/moments.



Looking at the lines in the diagram, we see that in particular for cross-sections reinforced at all sides the neglect of the underlying linear relationship in the Standard is *not* the safe side. In reality, a greater moment or a greater curvature will result.

The area not covered by the standard is shown in the graphic in red.

5.5 Results Windows

5.5.1 Window 2.1 Check

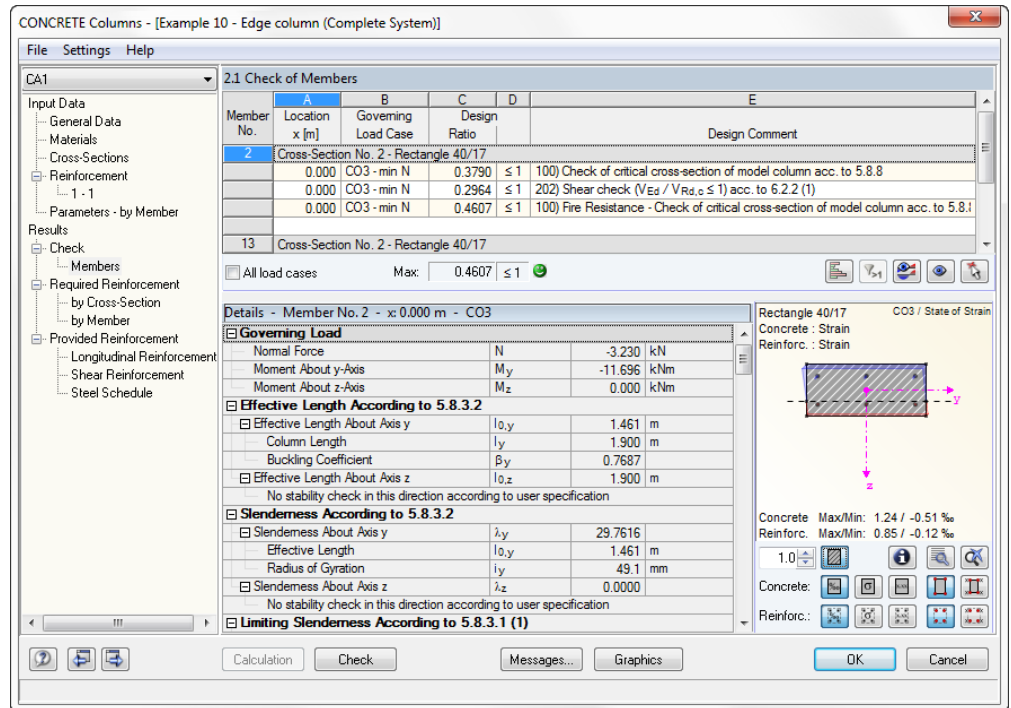


Figure 5.86: Window 2.1 Check

This window consists of an upper table as well as a lower details table and a graphic window. The lower part changes as soon as a certain row is selected in the upper table.

The first column of the upper table shows the number of the member, followed by several corresponding rows to the right of it. In each row, you find the result of a check.

The number of rows can change depending on the check required for a member. The type of the check is given in the column *Design Comment*. The check of safety against bending failure with the provided reinforcement is obligatory for every member. The check is performed with the applied second order moments in the governing cross-section of the member, idealized as a model column. If no stability analysis is necessary, the check is performed with the unchanged RSTAB internal forces and moments at the location for which the smallest safety is determined.

You find the location for which the check is performed indirectly in the first column of the upper table. There you can see which loading (load case, load combination, or result combination) is governing and which internal force has a minimum or maximum value at the governing location. The location at which the internal force is governing can be seen in the details table. This location is given as distance x from the column start.

The columns **B** and **C** of the upper table show the provided design criterion that must be always less than 1 for a successful design. This design criterion is obtained by dividing the effect of action by the resistance.

In the first row of the upper table, the safety γ determined with the provided reinforcement is taken as dividend for the required safety of 1. Thus, if the provided safety is sufficient ($\gamma \geq 1$), the design criterion will also be less than 1.

In the upper table, there are further rows for various checks, for example the various shear checks at the governing locations. Depending on the loading, the number of the design to be performed and, therefore, the number of rows of the upper table can vary. It depends on the standard and the type of loading which checks are performed. For a more detailed description, see chapter 4 of this manual.

Depending on the selected row of the upper table, the intermediate results of this check appear in the details table. They have the order of a manual calculation and, therefore, show chronologically all intermediate values used for the determination of the design criterion. As the content of the details table can be found in the examples later in this manual, only the main entries of the intermediate results are described in this chapter.

If the second order moments are determined for the method based on nominal curvature, the following main entries will be shown for the safety check against bending failure in the *Details* table:

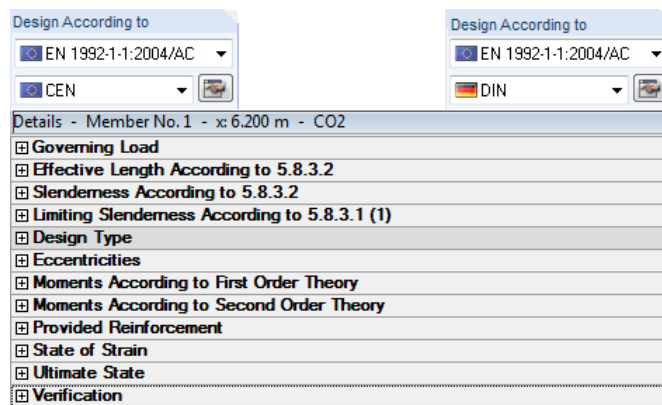


Figure 5.87: Details for the design with second order moments (EN and DIN EN 1992-1-1)

If the standard design is sufficient, the *Details* are reduced to the main entries *Moments According to First Order Theory* and *Moments According to Second Order Theory*. The design will then be carried out with the unchanged internal forces and moments from RSTAB.

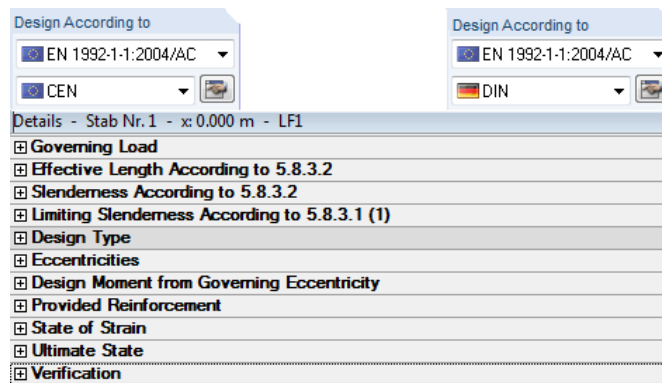


Figure 5.88: Details for the standard design

Governing loading

Governing Load			
Load		LC1	
Governing Internal Forces		min M_y	
At Location	x	0.000	m
Normal Force	N	-875.000	kN
Moment About y-Axis	M_y	-90.000	kNm
Moment About z-Axis	M_z	60.000	kNm

Figure 5.89: Governing loading

The first row of the governing load case gives the governing load combination or the governing result combination.

This loading results in a certain distribution across the member of the axial force, the moments, as well as the shear forces related to local member axes y and z.

The distribution of every internal force reaches a maximum or minimum at a certain location. These extreme values are analyzed in the way described in chapter 4. The *Governing Internal Force* is shown in the second row. The next row shows the distance from the member start of this extreme value. In addition to the governing internal force, there are the corresponding internal forces that are given in the following rows. The design is carried out with these internal forces.

Effective Length / Slenderness

The main entries *Effective Length*, *Slenderness*, and *Limiting Slenderness* are used only to determine if a design is carried out with second order moments or a standard design is performed with internal forces from RSTAB.

Intermediate Results Rectangle 40/45 - CO4			
Governing Load			
Effective Length According to 5.8.3.2			
Effective Length About Axis y	$l_{0,y}$	13.020	m
Column Length	l_y	6.200	m
Buckling Coefficient	β_y	2.100	
Effective Length About Axis z	$l_{0,z}$	6.200	m
No stability check in this direction according to user specification			
Slenderness According to 5.8.3.2			
Slenderness About Axis y	λ_y	100.2280	
Effective Length	$l_{0,y}$	13.020	m
Radius of Gyration	i_y	129.9	mm
Slenderness About Axis z	λ_z	0.0000	
No stability check in this direction according to user specification			
Limiting Slenderness According to 5.8.3.1 (1)			
Limiting Slenderness About Axis y	$\lambda_{lim,y}$	33.5184	

Figure 5.90: Specifications of effective length, slenderness, and limiting slenderness according to EN 1992-1-1

Design Type

This entry shows whether it is required to determine the second order internal forces.

Details - Member No.1 - x: 6.200 m - CO1		
<input type="checkbox"/> Design Type		
<input type="checkbox"/> Conditions of standard design according to 5.8.3.1 (1)		
<input type="checkbox"/> Condition About Axis y	$\lambda_y \leq \lambda_{lim,y}$	Failed
<input type="checkbox"/> Slenderness Provided	λ_y	58.2277
<input type="checkbox"/> Limiting Slenderness About Axis y	$\lambda_{lim,y}$	44.0833
<input type="checkbox"/> Condition About Axis z	$\lambda_z \leq \lambda_{lim,z}$	Failed
<input type="checkbox"/> Slenderness Provided	λ_z	107.3870
<input type="checkbox"/> Limiting Slenderness About Axis z	$\lambda_{lim,z}$	44.0833
<input type="checkbox"/> Condition of standard design fulfilled?		Failed
<input type="checkbox"/> Conditions of standard design according to 5.8.3.1 (1)		
<input type="checkbox"/> System immobile?		No
<input type="checkbox"/> No load moment(s) at the end of the colu		No
<input type="checkbox"/> Column not loaded by shear load?		No
<input type="checkbox"/> Normal force distribution constant?		No
<input type="checkbox"/> Normal force is not a compressive force?		No
<input type="checkbox"/> Condition of standard design fulfilled?		No
<input type="checkbox"/> Stability Check Required		

Figure 5.91: Specifying the type of design according to EN 1992-1-1

The conditions for the standard design about the y-axis and about the z-axis were not met. Therefore, the second order internal forces must be determined.

Moments According to First Order Theory

The last row of the entry Design Type shows whether or not the conditions for a standard design have been met. If you see a *No* there, the next main entry will be *Moments According to First Order Theory*.

Intermediate Results Rectangle 300/400 - LC1			
<input type="checkbox"/> Moments According to First Order Theory			
<input type="checkbox"/> Moments According to First Order Theory			
<input type="checkbox"/> Design Normal Force	N _{Ed}	-875.000	kN
<input type="checkbox"/> Moment About Axis y	M _{Ed,1,y}	-96.563	kNm
<input type="checkbox"/> Calculated Total Eccentricity in z-Direc	e _{calc,1,z}	-110.4	mm
<input type="checkbox"/> Intended Eccentricity	e _{0,z}	-102.9	mm
<input type="checkbox"/> Eccentricity Due to Imperfection	e _{i,z}	-7.5	mm
<input type="checkbox"/> Moment About Axis z	M _{Ed,1,z}	66.563	kNm
<input type="checkbox"/> Calculated Total Eccentricity in y-Direc	e _{calc,1,y}	76.1	mm
<input type="checkbox"/> Intended Eccentricity	e _{0,y}	68.6	mm
<input type="checkbox"/> Eccentricity Due to Imperfection	e _{i,y}	7.5	mm

Figure 5.92: First Order Moments

The first order moments are determined from the product of axial force and intended eccentricity plus the unintended eccentricity. The determination of these eccentricities is shown in the following rows. The main entry *Moments According to First Order Theory* is concluded by the output of these moments.

Moments According to Second Order Theory

Intermediate Results Rectangle300/400 - LC1			
<input checked="" type="checkbox"/> Moments According to Second Order Theory			
<input checked="" type="checkbox"/> Eccentricity Through Second Ord. Th. According to 5.8.8.2(3)			
<input checked="" type="checkbox"/> Eccentricity (First Ord. Th.) in z-direction	$e_{2,z}$	-11.9	mm
<input checked="" type="checkbox"/> Eccentricity (First Ord. Th.) in y-direction	$e_{2,y}$	21.9	mm
<input checked="" type="checkbox"/> Moments According to Second Order Theory			
<input type="checkbox"/> Design Normal Force	N_{Ed}	-875.000	kN
<input checked="" type="checkbox"/> Moment About Axis y	$M_{Ed,y2}$	-106.957	kNm
<input checked="" type="checkbox"/> Moment About Axis z	$M_{Ed,z2}$	85.723	kNm

Figure 5.93: Second Order Moments

The determination starts with the calculation of the second order eccentricities. The figure above does not show all result rows. The following rows show, for example, the provided reinforcement that has a significant influence on the second order eccentricities.

If these eccentricities are known, the second order moments about the axes of the member coordinate system can be determined with the axial force.

Thus, the internal forces are known with which the provided safety against bending failure is to be determined.

Provided Reinforcement

To determine the safety against bending failure, the provided longitudinal reinforcement must be determined first. It can be found in the main entry *Provided Reinforcement*.

<input checked="" type="checkbox"/> Provided Reinforcement			
<input checked="" type="checkbox"/> From Item	No.		1
<input type="checkbox"/> Item Statically Effective			Yes
<input type="checkbox"/> Rebar Diameter	d_s	0.020	m
<input type="checkbox"/> Area of Cross-Section per Rebar	a_s	3.14	cm ²
<input type="checkbox"/> Number	n_s	8	
<input type="checkbox"/> Total Reinforcement Area	prov A_s	25.12	cm ²
<input checked="" type="checkbox"/> From Item	No.		2
<input type="checkbox"/> Item Statically Effective			Yes
<input type="checkbox"/> Rebar Diameter	d_s	0.020	m
<input type="checkbox"/> Area of Cross-Section per Rebar	a_s	3.14	cm ²
<input type="checkbox"/> Number	n_s	2	
<input type="checkbox"/> Total Reinforcement Area	prov A_s	6.28	cm ²
<input type="checkbox"/> Provided Reinforcement	prov A_s	31.42	cm ²

Figure 5.94: Provided Reinforcement

Here, the current reinforcement is shown by item numbers. This provided reinforcement is proposed by the program after the first calculation and can be changed in window 3.1 *Longitudinal Reinforcement Provided*.

State of Strain

The next four figures show the strains and stresses with the previously determined internal forces in the concrete and reinforcement.

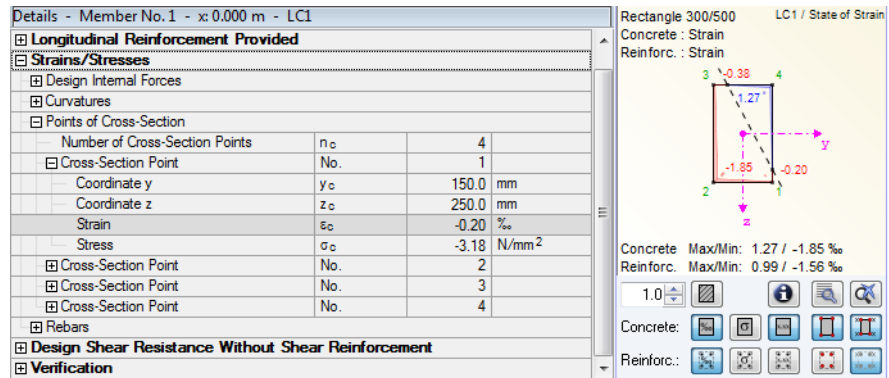


Figure 5.95: Strain - concrete

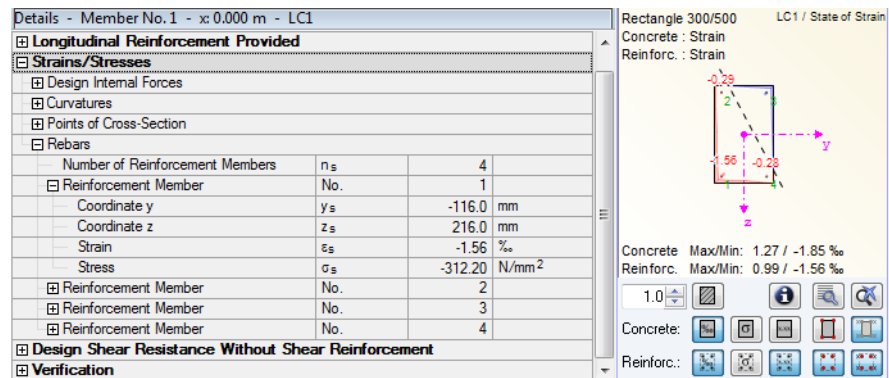


Figure 5.96: Strain - concrete

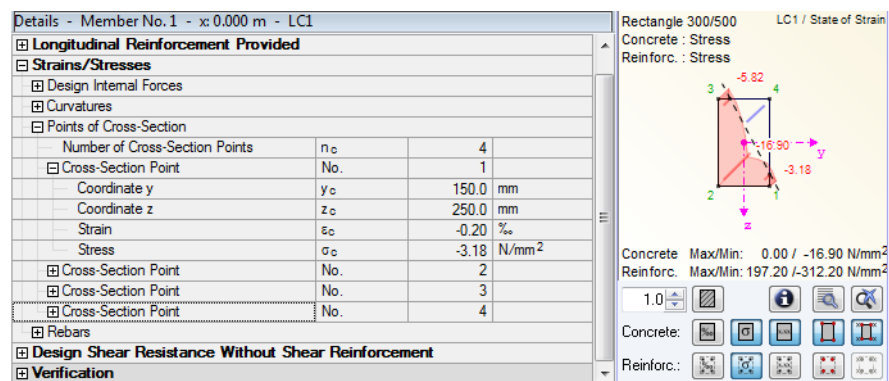


Figure 5.97: Strain - concrete

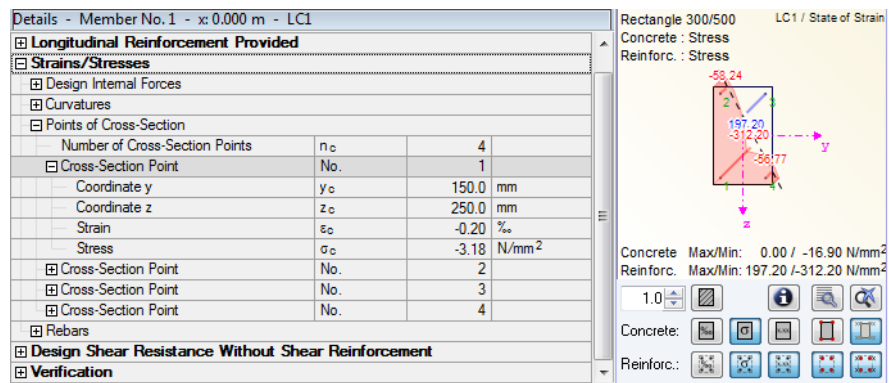


Figure 5.98: Strain - reinforcement

On the right-hand side, a graphic shows the distribution of strains and stresses. Below the graphic, there are various buttons controlling the view.

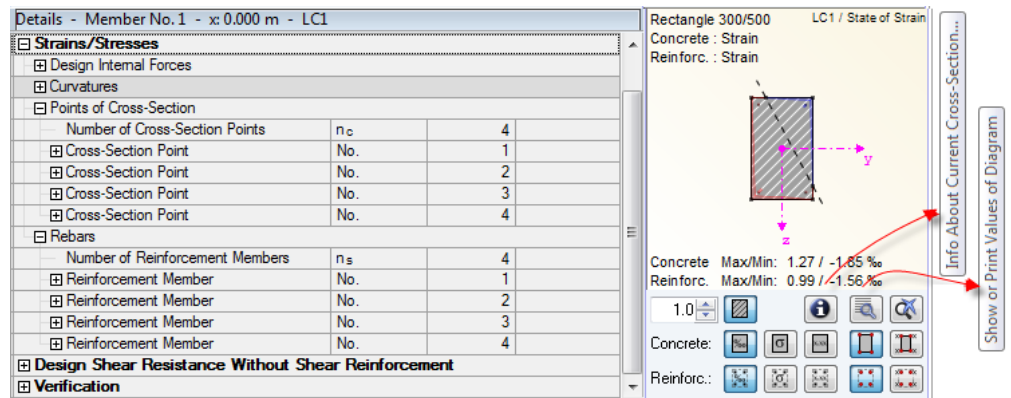


Figure 5.99: Info and values



To display information about the cross-section, click [Info] (see the following figure).

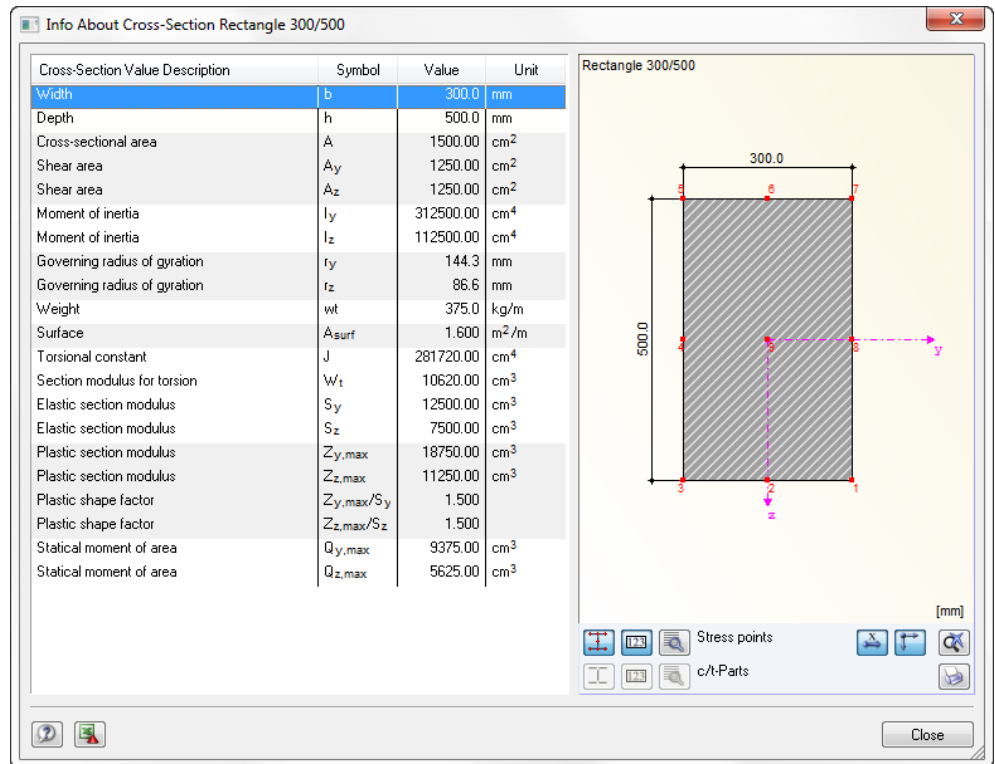


Figure 5.100: Dialog box *Info About Cross-Section*



To display the values of the diagram, click [Values]. This button opens a dialog box showing the strains and stresses in two clearly-arranged tables for steel and concrete, respectively.

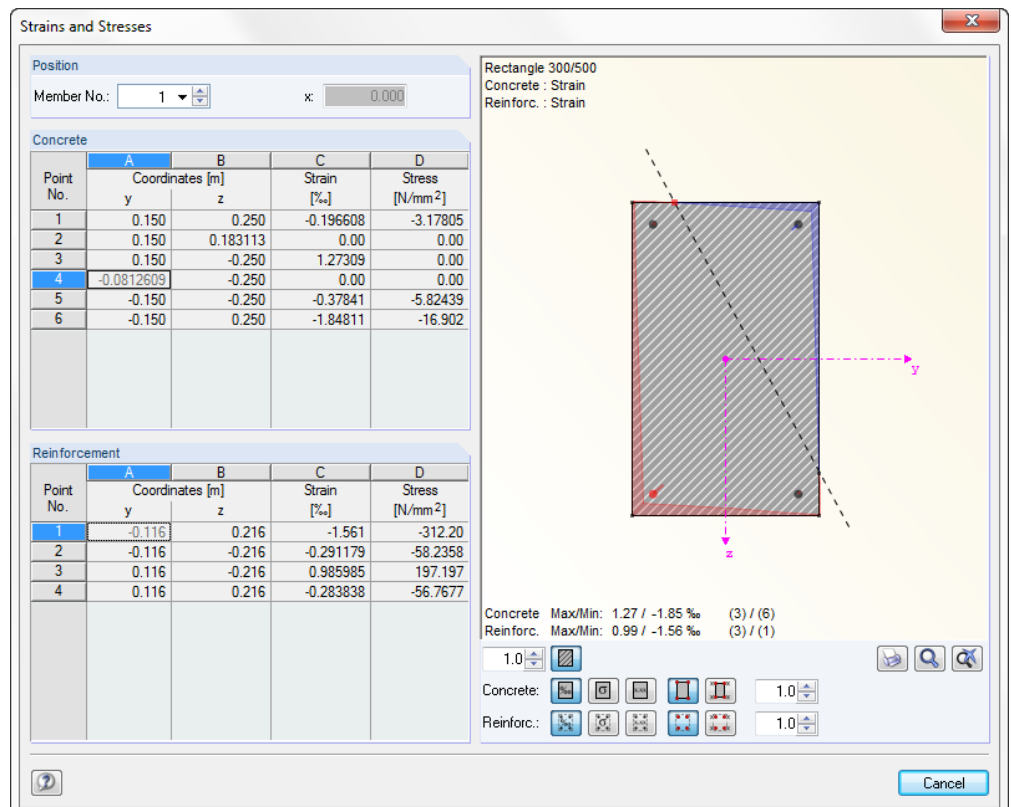


Figure 5.101: Dialog box for the display of strains and stresses

On the left side of the dialog box, you find the dialog box sections *Position*, *Concrete*, and *Reinforcement*.

In the dialog box section *Position*, select the member for which you want to display the stress or strain diagram. Then, the design relevant location of the column is shown in the field "x" to the right of it.

The coordinates of the stress and reinforcement points are displayed in the two tables below. These coordinates relate to the member coordinate system shown in the graphic on the right.

In the columns **C** and **D**, the respective *Strains* and *Stresses* are listed. Their extreme values are shown separately for the reinforcement and the concrete below the graphic. The number in the brackets at the end of each row is the number of the stress and reinforcement point as it is shown in the column Point No. of both tables.

Below the graphic window, there are various buttons with which you can change the view.



Figure 5.102: Button to change the graphical representation

The buttons in the row *Concrete* mean (from left to right):

- Hide or display the filled cross-section
- For both concrete and reinforcement:
- Show strain diagram
- Show stress diagram
- Values of the diagram
- Show points
- Numbering of points

To change the graphic size, use the spin box at the end of the row.

There are also the following buttons in this dialog box:



Figure 5.103: Buttons

To open the dialog box managing the printout of the stress-strain-graphic directly from this module, click the first button, [Print].

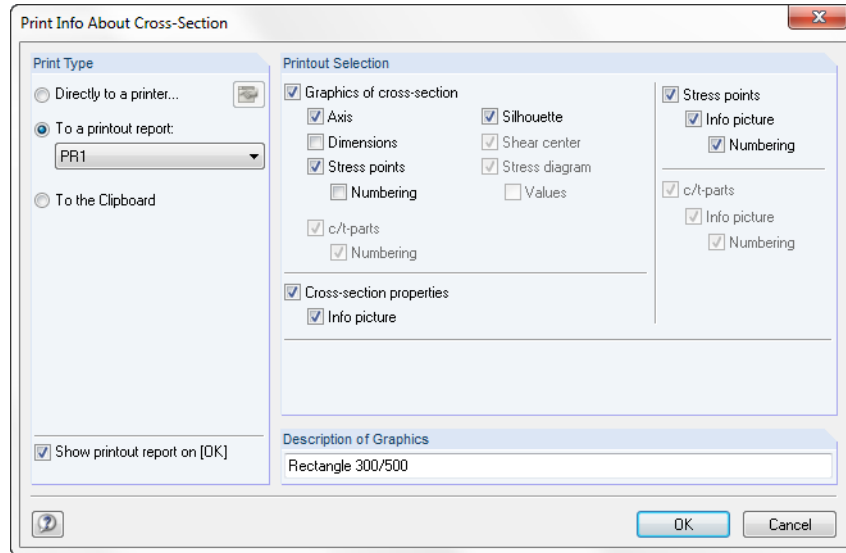


Figure 5.104: Printing the cross-section details

If you confirm this dialog box by clicking [OK], the printout report with the graphical representation of the strains and stresses appears. To return to the dialog box, click [Cancel].

To change the pointer into a hand and to shift or zoom in or out the graphic, ...



Figure 5.105: Buttons

... click the button in the middle.

To restore the initial view of the graphic after a change, click the last button.

These three buttons, which are used to change the graphical representation, can also be seen in the window 2.1 *Check of Members*, from which this dialog box can be opened, too.

Ultimate State

The next main entry in the details table is *Ultimate State*. It shows the distribution of the strain and stress for the ultimate internal forces. The ultimate internal forces are obtained by multiplying the applied internal forces with the determined safety factor γ .

Details - Member No. 1 - x: 3.000 m - LC1			
<input checked="" type="checkbox"/> Design Type			
<input checked="" type="checkbox"/> Eccentricities			
<input checked="" type="checkbox"/> Moments According to First Order Theory			
<input checked="" type="checkbox"/> Moments According to Second Order Theory			
<input checked="" type="checkbox"/> Provided Reinforcement			
<input checked="" type="checkbox"/> State of Strain			
<input checked="" type="checkbox"/> Ultimate State			
<input type="checkbox"/> Ultimate Internal Forces			
Ultimate Normal Force	N_u	-1376.560	kN
Ultimate Moment About y-Axis	$M_{y,u}$	94.200	kNm
Ultimate Moment About z-Axis	$M_{z,u}$	87.934	kNm
<input type="checkbox"/> Ultimate Curvatures			
Ultimate Curvature in Plane z	$1/r_{z,u}$	0.005	1/m
Ultimate Curvature in Plane y	$1/r_{y,u}$	-0.011	1/m
<input type="checkbox"/> Points of Cross-Section			
<input type="checkbox"/> Rebars			
<input checked="" type="checkbox"/> Verification			

Figure 5.106: Ultimate state

Verification

The design criterion is determined in the last main entry *Verification*. This criterion is also shown in the upper table in the row of this check.

Details - Member No. 1 - x: 3.000 m - LC1			
<input checked="" type="checkbox"/> Moments According to First Order Theory			
<input checked="" type="checkbox"/> Moments According to Second Order Theory			
<input checked="" type="checkbox"/> Provided Reinforcement			
<input checked="" type="checkbox"/> State of Strain			
<input checked="" type="checkbox"/> Ultimate State			
<input checked="" type="checkbox"/> Verification			
Required Safety of Ultimate State	req γ	1.0	
Provided Safety of Ultimate State	prov γ	1.5533	
<input type="checkbox"/> Design Internal Forces			
Normal Force	N_{Ed}	-886.250	kN
Moment About y-Axis According to Sec	$M_{Ed,y2}$	60.647	kNm
Moment About z-Axis According to Sec	$M_{Ed,z2}$	56.613	kNm
<input type="checkbox"/> Ultimate Internal Forces			
Ultimate Normal Force	N_u	-1376.560	kN
Ultimate Moment About y-Axis	$M_{y,u}$	94.200	kNm
Ultimate Moment About z-Axis	$M_{z,u}$	87.934	kNm
Design Criterion (req γ / prov γ)	Criterion	0.6438	

Figure 5.107: Verification

The maximum design criterion is shown below the window 2.1 *Check of Members*. This criterion is compared with the limit value.


Member No.	A	B	C	D	E
	Location x [m]	Governing Load Case	Design Ratio		Design Comment
1	Cross-Section No. 1 - Rectangle 300/500				
	0.000	LC1 - min M_y	0.7359	≤ 1	100) Check of critical cross-section of model column acc. to 5.8.8
	3.000	LC1 - min N	0.1160	≤ 1	201) Shear check ($V_{Ed} / V_{Rd,c} \leq 1$) acc. to 6.2.2 (2) with (6.4)
	0.000	LC1 - min M_y	0.6336	≤ 1	202) Shear check ($V_{Ed} / V_{Rd,c} \leq 1$) acc. to 6.2.2 (1)
<input checked="" type="checkbox"/> All load cases Max: 0.7359 ≤ 1 					

Figure 5.108: Maximum design criterion

There are further buttons to the right of it.

For a colored representation of the design criterion in the corresponding cells, click [Show color bars]. The length of the colored scales in this column is directly proportional to the magnitude of the design criterion. If the design criterion exceeds the value 1, the scale is shown in red.

The second button filters the rows with a design criterion greater than 1.

The third button shows the result diagrams of the current member.

The fourth button with the eye symbol allows you to select the RSTAB view mode.

To go to the RSTAB work window, use the arrow buttons. In the RSTAB work window, you can select the member whose check you want to be displayed in the upper table.

Below the upper table, there is the check box *All load cases*.

If this check box is selected, the checks with the governing load for a member are displayed in the upper table. In addition to that, the table shows all checks for every load case, every load combination, or every result combination selected in window 1.1 *General Data*.

5.5.2 Window 3.1 Required Reinforcement by Cross-Section

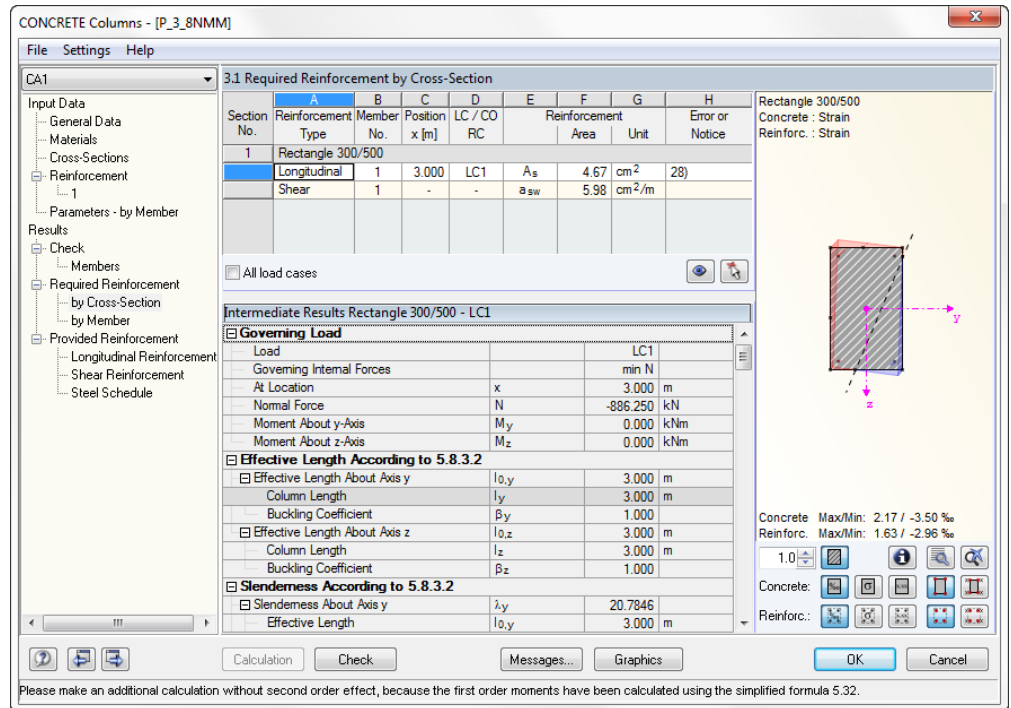


Figure 5.109: Window 3.1 Required Reinforcement by Cross-Section

This window is conceptually similar to the window 3.2 *Required Reinforcement by Member*. The upper table displays the required longitudinal reinforcement A_s and the required shear reinforcement a_{sw} . If you click the corresponding row in the upper table, the details table below shows all intermediate results needed for the determination of this reinforcements.

The first column of the upper table shows the number of the cross-section under consideration. The description of the cross-section is to the right of it. Column A shows the reinforcement type, that means whether the required reinforcement is longitudinal or shear reinforcement.

3.1 Required Reinforcement by Cross-Section								
Section No.	A	B	C	D	E	F	G	H
	Reinforcement Type	Member No.	Position x [m]	LC / CO RC	Reinforcement			Error or Notice
					Area	Unit		
1	Rectangle 300/500							
	Longitudinal	1	3.000	LC1	A_s	4.67 cm ²	28)	
	Shear	1	-	-	a_{sw}	5.98 cm ² /m		

Figure 5.110: Upper table

Column B shows the number of the member that uses this cross-section. Column C shows the design relevant location x. Column D shows the governing loading. Column F shows the required reinforcement area. The last column H can show the number of an error or notice. This warning is explained in the status bar of the window.

The details for the determination of the required longitudinal reinforcement A_s do not differ up to the entry *Moments According to Second Order Theory* from the details for the determination of the provided safety in window 2.1 *Check of Members* (the same loading is assumed).

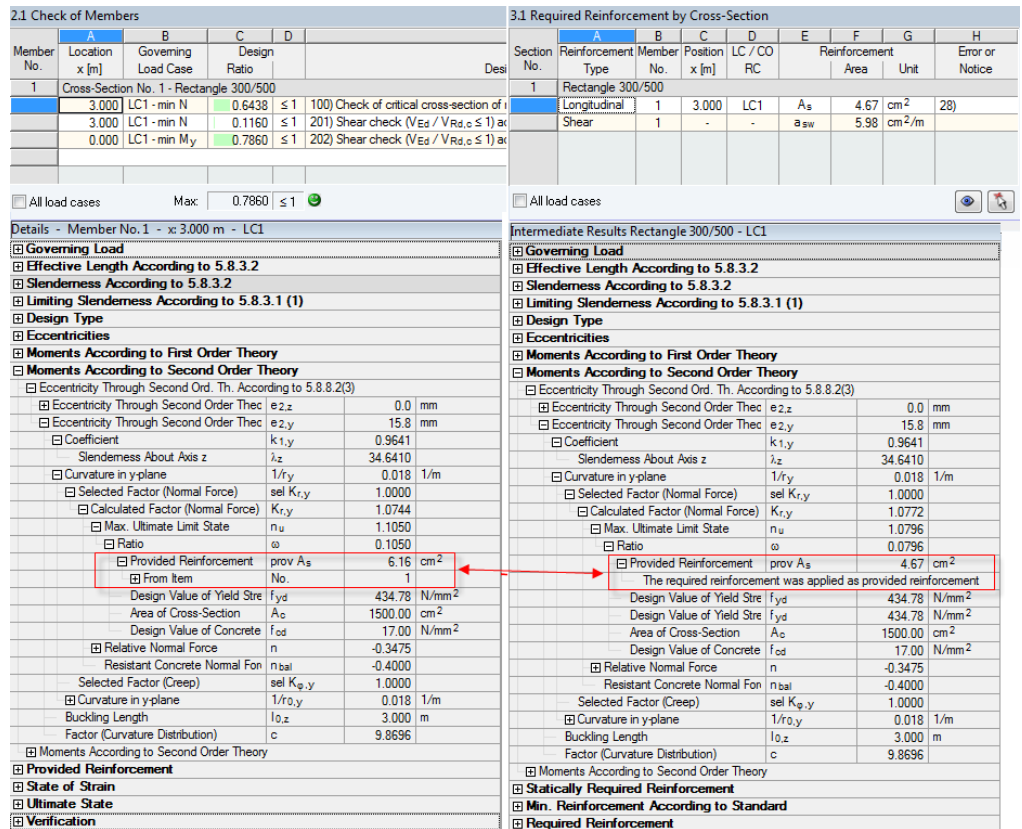


Figure 5.111: Comparison of the details

In the details table of window 2.1, the previously calculated actual reinforcement is used in the determination of the limiting slenderness λ_{lim} and the *Moments According to Second Order Theory*. In window 3.1, however, the statically required reinforcement is used.

From this entry on, the details tables of the two output windows differ. In the details table of window 3.1, the program uses the second order moments or the applied internal forces from RSTAB to determine the statically required reinforcement. This is done in the main entry *Statically Required Reinforcement*. This entry shows in the respective rows the strains and stresses in the stress and reinforcement points obtained from the design.

The reinforcement points are the assumed layers of the centroids of the rebars inserted later. This assumed layer is significantly influenced by the user-defined specifications in window 1.3 *Reinforcement* (see the following figure).

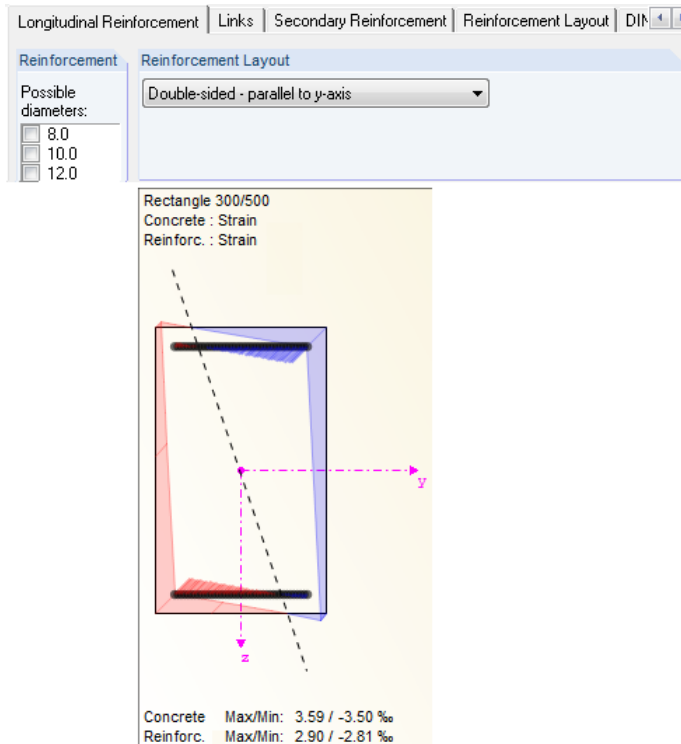


Figure 5.112: Arrangement of the reinforcement points

To view the stresses and strains in tables, the same options are available as in the 2.1 *Check of Members* window.

Upon the determination of the statically required reinforcement, the minimum reinforcement is carried out in the main entry *Min. Reinforcement*. You can set the minimum reinforcement in window 1.4 *Reinforcement*, tab *Standard*:

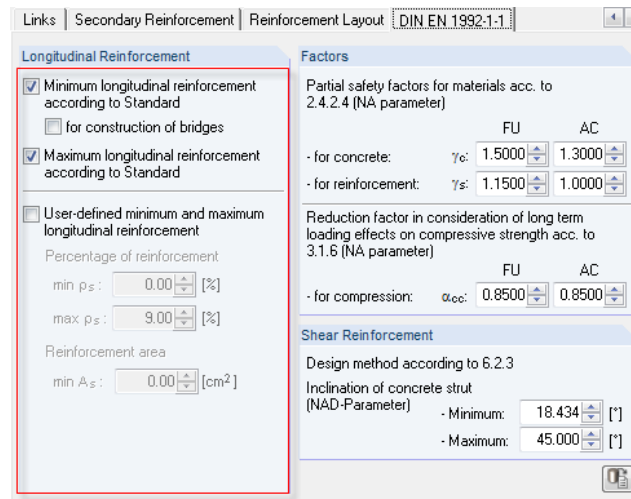


Figure 5.113: Specification of the minimum reinforcement in window 1.4

To determine the minimum reinforcement with the applied internal forces according to the following expressions of the respective standards, select the check box in the section highlighted in the figure.

DIN EN 1992-1-1 specifies the following minimum reinforcement for the column to be:

$$A_{s,min} = \max (0.10 N_{ed} / f_{yd} , 0.002A_c) \quad 9.5.2(2)$$

EN 1992-1-1 specifies the following minimum reinforcement:

$$A_{s,min} = 0.15 \cdot \frac{N_{Ed}}{f_{yd}}$$

Depending on the standard, the details table shows the following intermediate results for the determination of the minimum reinforcement:

Min. Reinforcement According to Standard			
Design Normal Force	N_{Ed}	-875.000	kN
Design Value of Yield Stress	f_{yd}	434.78	N/mm ²
Minimum Reinforcement Acc. to Standard	req $A_{s,min,Stand}$	3.02	cm ²

Figure 5.114: Minimum reinforcement according to DIN EN 1992-1-1

Min. Reinforcement According to Standard			
1st Minimum Reinforcement			
Design Normal Force	N_{Ed}	-875.000	kN
Design Value of Yield Stress	f_{yd}	434.78	N/mm ²
Min. Reinforcement	req $A_{s,min,1}$	2.01	cm ²
2nd Minimum Reinforcement			
Area of Cross-Section	A_c	1500.00	cm ²
Min. Reinforcement	req $A_{s,min,2}$	3.00	cm ²
Minimum Reinforcement Acc. to Standard	req $A_{s,min,Stand}$	3.00	cm ²

Figure 5.115: Minimum reinforcement according to EN 1992-1-1

In addition to that, you can define a user-defined minimum reinforcement. The minimum reinforcement that was determined in this way also appears in the details table.

User-Defined Minimum Reinforcement			
Area of Cross-Section	A_c	1500.00	cm ²
Minimum Percentage of Reinforcement	Min ρ_s	0.30	%
Minimum Area of Reinforcement	req $A_{s,min,1}$	4.50	cm ²

Figure 5.116: User-defined minimum reinforcement

The last main entry *Required Reinforcement* of the details table shows which is the greater reinforcement from the statically required reinforcement and the minimum reinforcement. The greater of both reinforcements is then given as the required reinforcement in the respective row of the upper table.

Required Reinforcement			
Statically Required Reinforcement	req $A_{s,stat}$	5.02	cm ²
Minimum Reinforcement Acc. to Standard	req $A_{s,min,Stand}$	3.06	cm ²
Required Reinforcement	req A_s	5.02	cm ²

Figure 5.117: Required Reinforcement

The *All load cases* check box is also available in the 3.1 *Required Reinforcement by Cross-Section* window. To display the required reinforcement sorted by cross-section for every load case, select this check box.

3.1 Required Reinforcement by Cross-Section							
Section No.	Reinforcement Type	Member No.	Position x [m]	LC / CO RC	Reinforcement		Error or Notice
					Area	Unit	
1	Rectangle 40/45						
	Longitudinal	1	6.200	CO2	A_s	30.78	cm ²
	Shear	1	-	-	a_{sw}	4.19	cm ² /m
1	Rectangle 40/45						
	Longitudinal	1	0.000	CO3	A_s	15.21	cm ²
	Shear	1	-	-	a_{sw}	4.19	cm ² /m
1	Rectangle 40/45						
	Longitudinal	1	0.000	CO4	A_s	27.08	cm ²
	Shear	1	-	-	a_{sw}	4.19	cm ² /m



All load cases  

Figure 5.118: Display of the results of all calculated load combinations

The table above shows that a rectangular cross-section was analyzed by the program. The cross-section *Rectangle 40/45* is used in member No. 1. This is shown in column **B**. The load combinations CO2, CO3, and CO4 were selected in the 1.1 *General Data* window.

A row with the respectively required reinforcement is shown for each of the three load combinations. This reinforcement is given in column **F**.

The figure above shows very clearly, which loading really results in the greatest reinforcement and, therefore, is governing. To compare, the reinforcement for the governing loading can be displayed by clearing the selection in the *All load cases* check box:

Section No.	A Reinforcement Type	B Member No.	C Position x [m]	D LC / CO RC	E Reinforcement Area	F Unit	G Error or Notice
1	Rectangle 40/45						
	Longitudinal	1	6.200	CO2	A_s	30.78 cm ²	
	Shear	1	-	-	a_{sw}	4.19 cm ² /m	

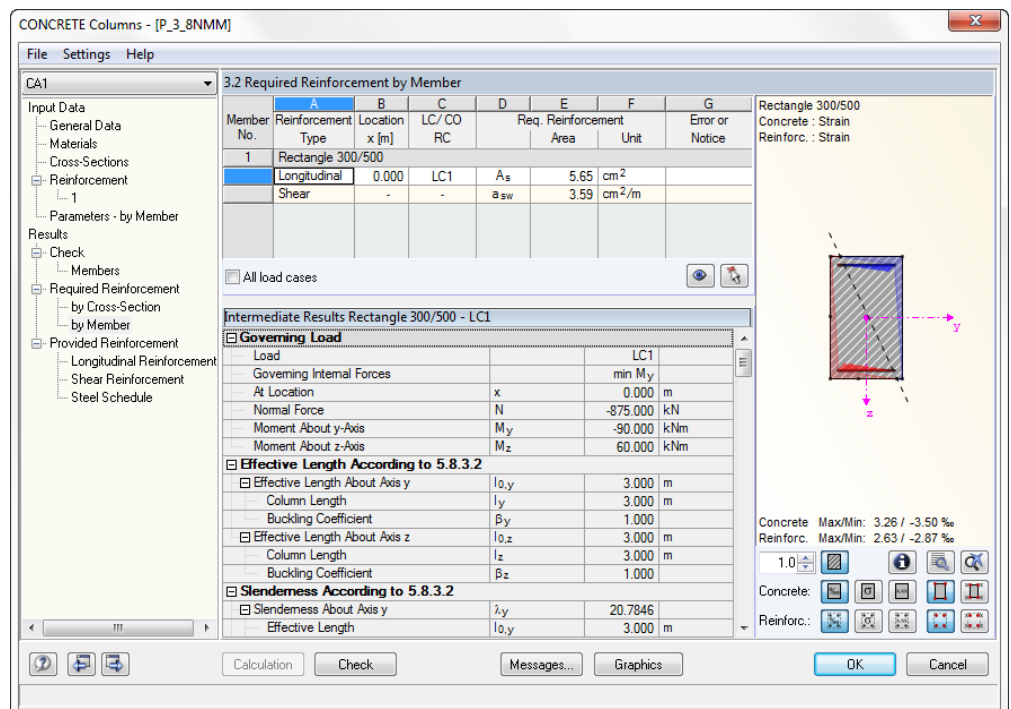
All load cases

Figure 5.119: Display of the governing loading

The design details of the required shear reinforcement can be controlled in the same way in the details table. For more information on the shear checks according to the different standards, see chapter 4.6, page 45ff.

5.5.3 Window 3.2 Required Reinforcement by Member

This window differs from the previous one only in the fact that in the left column the number of the member is given instead of the cross-section number. The description of the cross-section used for this member is shown in the row next to the cross-section number. Apart from this, every row shows the data described in the previous chapter 5.5.2.



The screenshot shows the software interface for 'CONCRETE Columns - [P_3_8NMM]'. The main window displays '3.2 Required Reinforcement by Member' with a table similar to Figure 5.119 but for member No. 1 and cross-section Rectangle 300/500. The table shows required reinforcement for Longitudinal and Shear reinforcement under load case LC1. Below the table, there is a section for 'Intermediate Results Rectangle 300/500 - LC1' which includes 'Governing Load' details (Load, Governing Internal Forces, At Location, Normal Force, Moment About y-Axis, Moment About z-Axis) and 'Effective Length According to 5.8.3.2' (Effective Length About Axis y and z, Column Length, Buckling Coefficient) and 'Slenderness According to 5.8.3.2' (Slenderness About Axis y, Effective Length). On the right side, there is a diagram of a rectangular cross-section with axes x and y, and a list of material properties for Concrete and Reinforcement. The window also includes a sidebar with a tree view of the project structure and various control buttons at the bottom.

Figure 5.120: Window 3.2 Required Reinforcement by Member

5.5.4 Window 4.1 Longitudinal Reinforcement Provided

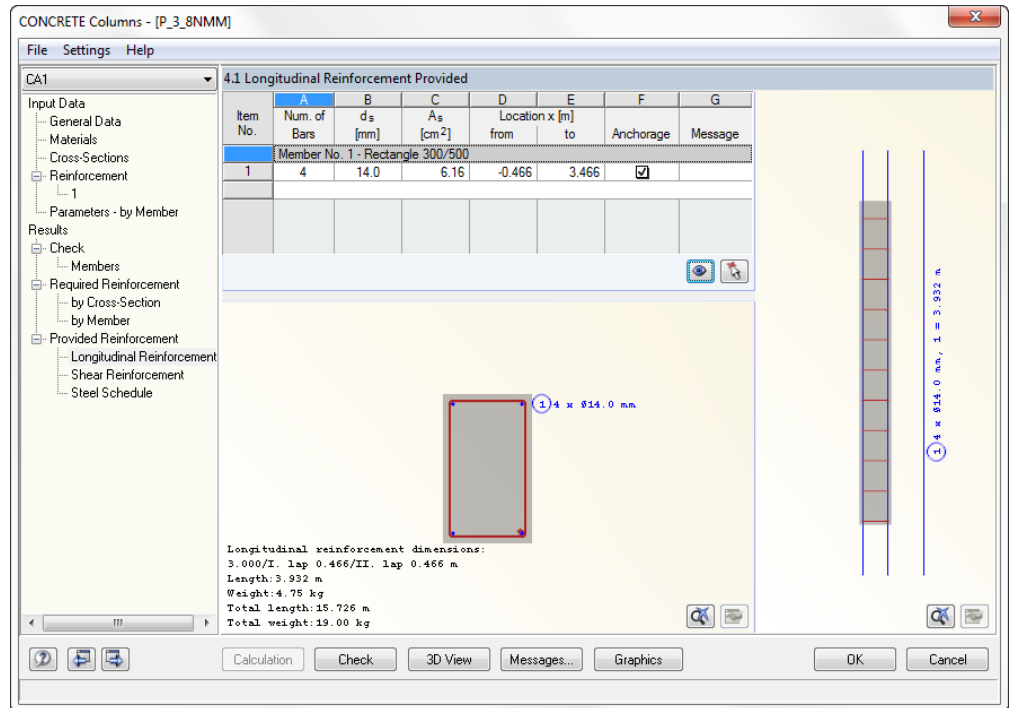


Figure 5.121: Window 4.1 Longitudinal Reinforcement Provided

This table allows for the modification of the longitudinal reinforcement calculated by the program. The required items are given for every member in a table. A continuous colored row shows the number of the member and the used cross-section. Below the row, the corresponding items of the member are shown.

The item number is shown in the first gray column of the table. The column A next to it shows this item's number of members. If you click in a cell of this column, the [...] button appears.

4.1 Longitudinal Reinforcement Provided							
Item No.	A	B	C	D	E	F	G
	Num. of Bars	d_s [mm]	A_s [cm ²]	Location x [m] from to		Anchorage	Message
Member No. 1 - Rectangle 300/500							
1	4 [...]	14.0	6.16	-0.466	3.466	<input checked="" type="checkbox"/>	

Figure 5.122: Existing items of a column

To open the *Edit Longitudinal Reinforcement* dialog box, click [...]. This dialog box will be described later.

In every cell of column B, you can open a drop-down list from which you can choose a different rebar diameter d_s for the current item.

4.1 Longitudinal Reinforcement Provided

Item No.	A	B	C	D		E	F	G
	Num. of Bars	d_s [mm]	A_s [cm ²]	Location x [m] from	to	Anchorage		
Member No. 1 - Rectangle 300/500								
1	4	14.0	6.16	-0.466	3.466	<input checked="" type="checkbox"/>		

Figure 5.123: Changing the bar diameter of an item

The content of columns **C** and **D** cannot be changed. These columns show the Location x as length of the reinforcement resulting from the anchorage. They are relating to the column start.

The penultimate column **E** *Anchorage* shows a check box. If you select this check box, the aforementioned *Edit Longitudinal Reinforcement* dialog box appears.

Edit Longitudinal Reinforcement | Element No. 1, Position No. 2

Design

Reinforcement bars statically effective

Diameter of Reinforcement

D: 14.0 [mm]

Position and Length

x from: 0.000 [m] Length without anchorage: 3.000 [m]

to: 3.000 [m] Length with anchorage: 3.621 [m]

Length: 3.000 [m] Total length: 14.484 [m]

Anchorage

	Anchorage Type	Composite	Percentage of Contact Sticks
Start:	Straight	Good	100.00 [%]
End:	Straight	Good	100.00 [%]

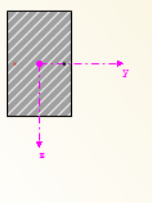
	Length of Anchorage	Bending Diameter
	l-1 l-2 Total	d-br
Start:	0.311 0.000 0.311 [m]	0.000 [m]
End:	0.311 0.000 0.311 [m]	0.000 [m]

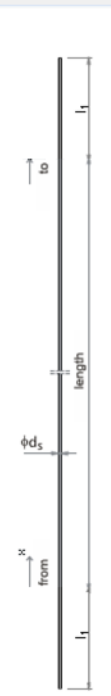
Position of Reinforcement Bars

Number: 4

No.	Coordinates		Hook Rotation β [°]
	y [mm]	z [mm]	
1	116.0	0.0	-90.000
2	116.0	0.0	180.000
3	116.0	0.0	-90.000
4	116.0	0.0	-90.000

Rectangle 300/500





OK Cancel

Figure 5.124: Dialog box for editing the provided longitudinal reinforcement

The dialog box section *Diameter of Reinforcement* contains a drop-down list in which a different rebar diameter can be selected for the current item. This input is identical to the selection in column **B** of the 4.1 *Longitudinal Reinforcement Provided* window.

During the design process, in addition to the statically required reinforcement, often a secondary intermediate reinforcement is determined to prevent that the distance between the rebars does not become greater than allowed. The program automatically applies this secondary reinforcement to the check of safety against bending failure in the 2.1 *Check of Members* window. You can, however, also deactivate certain items for the design of the provided safety. To do this, clear the selection of the *Reinforcement bars statically effective* check box.

To apply the changes, confirm by clicking [OK]. Thus, you return to the 4.1 *Longitudinal Reinforcement Provided* window.

Now, if you try to exit this window, the following message appears:

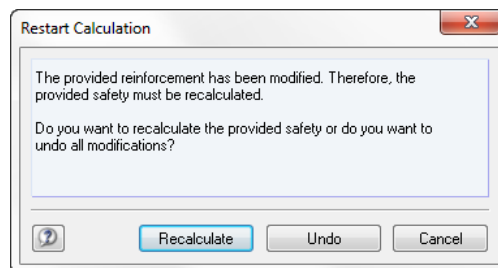


Figure 5.125: Dialog box *Restart Calculation*

Click [Recalculate] to reperform all designs of the 2.1 *Check of Members* window with the provided longitudinal reinforcement and the provided shear reinforcement of the 4.2 *Provided Shear Reinforcement* window.

To undo all changes that were made in the dialog box *Edit Longitudinal Reinforcement* dialog box, click [Undo].

To return to the 4.1 *Longitudinal Reinforcement Provided* window, click [Cancel]. All specifications made in the *Edit Longitudinal Reinforcement* dialog box are still present.

Next, we describe the *Anchorage* dialog box section in the dialog box *Edit Longitudinal Reinforcement* dialog box.

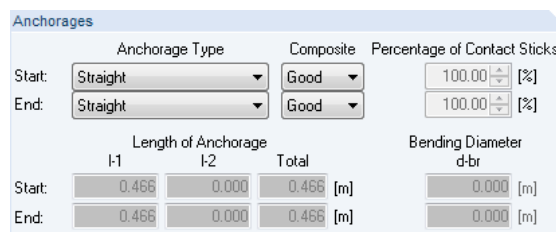


Figure 5.126: Section *Anchorage*

There are two identical drop-down lists used to select the *Anchorage Type* for the column start and column end, respectively.

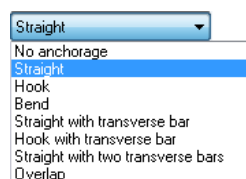


Figure 5.127: Anchorage type

Depending on the selected anchorage type, the required lengths $l-1$, $l-2$, and $l-3$ are shown in the dimmed text fields. The anchorage is also shown in the graphic on the right, visualizing it.

The position of the provided rebars can also be adjusted in this dialog box. In the *Position of Reinforcement Bars* dialog box section, you can modify the y - and z -coordinates of each rebar as well as its rotation about the longitudinal axis.

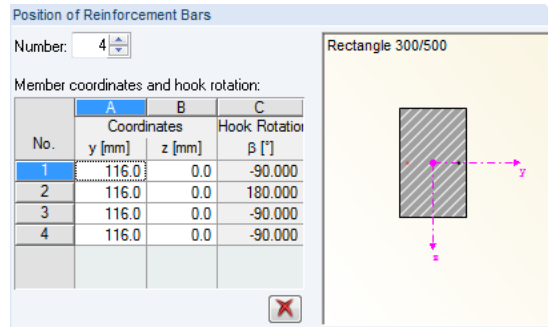


Figure 5.128: Section *Position of Reinforcement Bars*

To the right of the table, there is an interactive graphic. When you click a row in this table, the corresponding rebar is highlighted in red in the graphic.

5.5.5 Window 4.2 Shear Reinforcement Provided

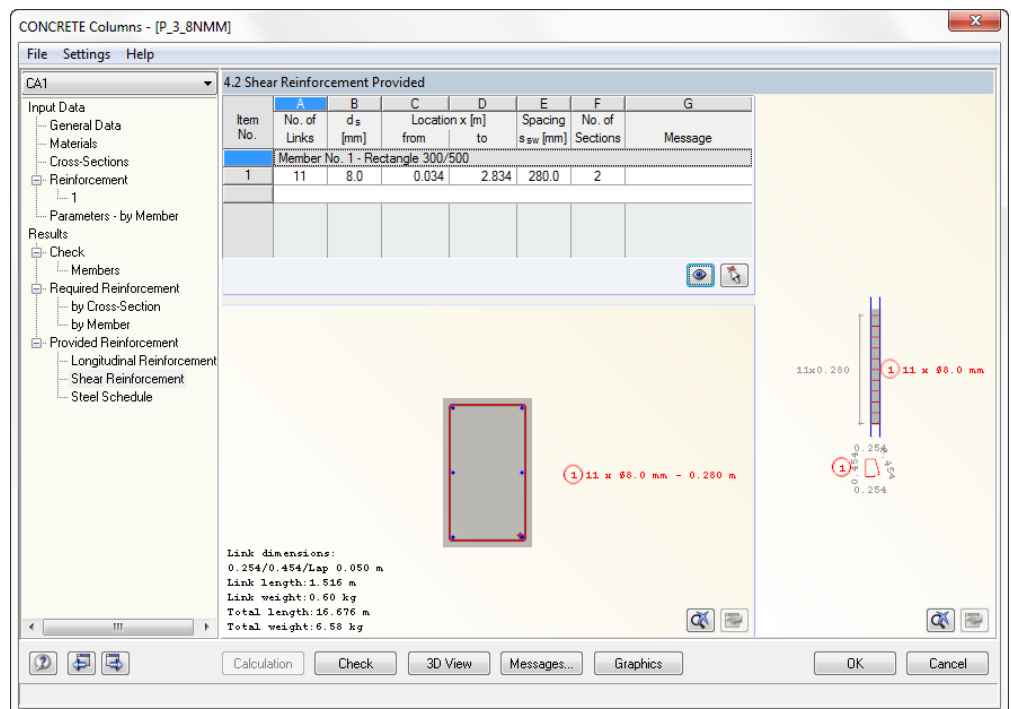


Figure 5.129: Window 4.2 *Shear Reinforcement Provided*

In this window, the items of the shear reinforcement are shown for every member row by row.

An *Item* is defined by the number of links (column A), the link diameter d_s (column B), the link spacing s_{sw} (column E), and the number of sections (column F).

The columns **C** and **D** *Location x* are especially important. In column D, the spacing of the first link is shown from the column start in meters. The x -location of the final link is stated in column E. The *Location x* relates to the x -axis of the local member coordinate system that starts at the node of a member.

The link layout can be illustrated by an example.

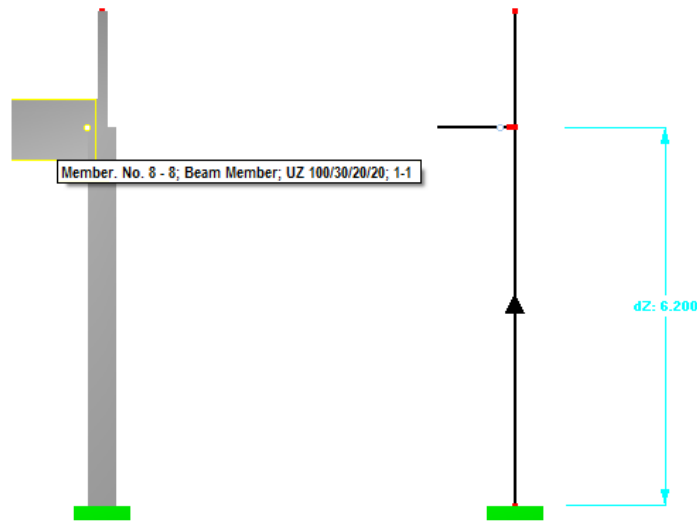


Figure 5.130: Display of a column in rendering mode and in model of center lines.

A beam connects to the left of the column selected for design. Therefore, the links are set only from the column start (support) to the bottom edge of the beam. The beam has a depth of 100 cm. Therefore, links are to be distributed over an effective length of 5.70 m. This length is obtained by subtracting half the beam depth (0.5 m) from the system length of the column (6.20 m).

Beginning at the column start (support), the links are placed at the maximum allowable distance from each other. The first link is placed at a distance that corresponds with the greatest longitudinal concrete side cover.

Next, further links are placed at this distance from one another until the previously determined effective length of 5.70 m is exceeded. Since this must not happen, the last link is undone. This results in the following link layout:

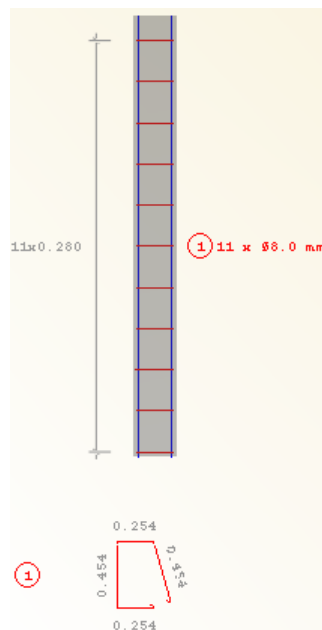


Figure 5.131: Display of the link layout

The link layout can already be influenced in the 1.5 *Column Parameters* input window.

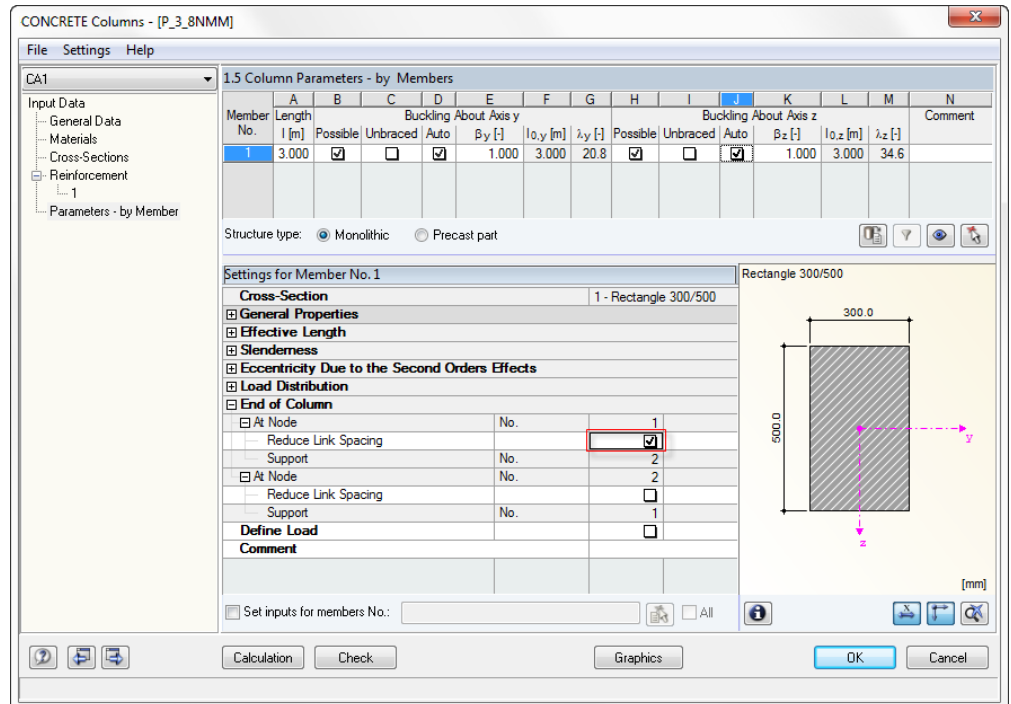


Figure 5.132: Window 1.5 *Column Parameters*

If the *Reduce Link Spacing* option is selected for the respective member at the node in the window shown above, the previously determined link distance is multiplied by factor 0.6 in a certain area of this member side. Thus, the link reinforcement is provided with an additional item in the area near the support:

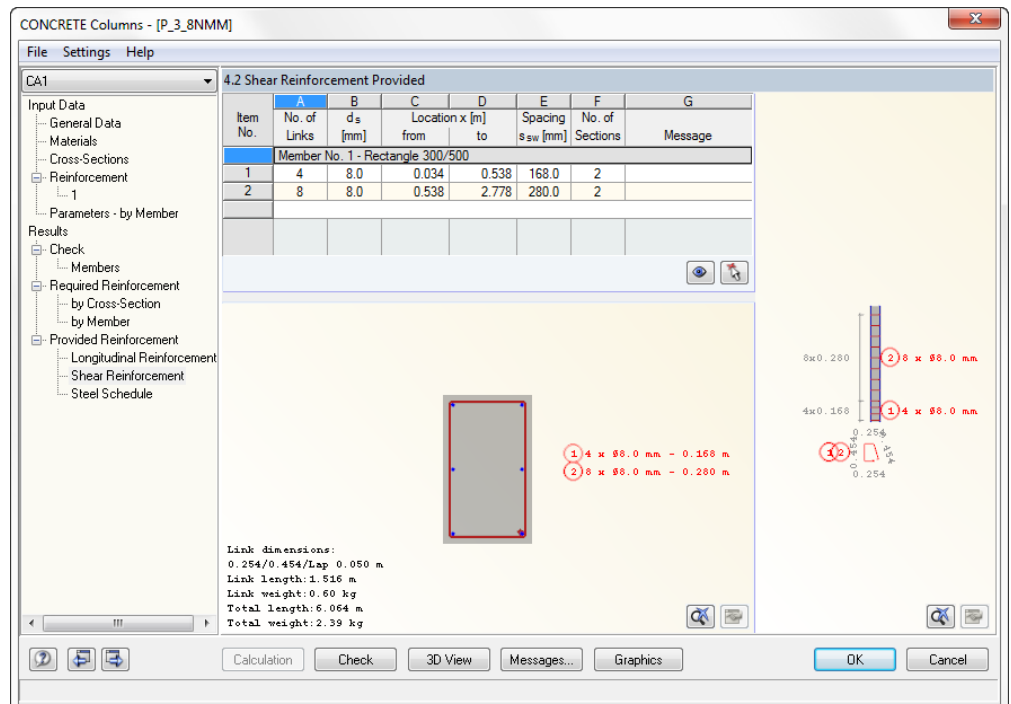


Figure 5.133: Window 4.1 *Shear Reinforcement Provided*

In the columns D and E, you can see that the end of the layout area for item 3 is at the same Location x as the start of the layout area of item 4.

Item No.	A	B	C		D	
	No. of Links	d_s [mm]	Location x [m]		from	to
Member No. 1 - Rectangle 300/500						
1	4	8.0	0.034	0.538		
2	8	8.0	0.538	2.778		

Figure 5.134: Start and end of the layout area

If you change the start of the layout area of position 4 from 2.778 to 2.00 (=converted to 1.938), the intermediate area is filled with another item. Furthermore, the message 29 appears, stating that the provided reinforcement has been changed.

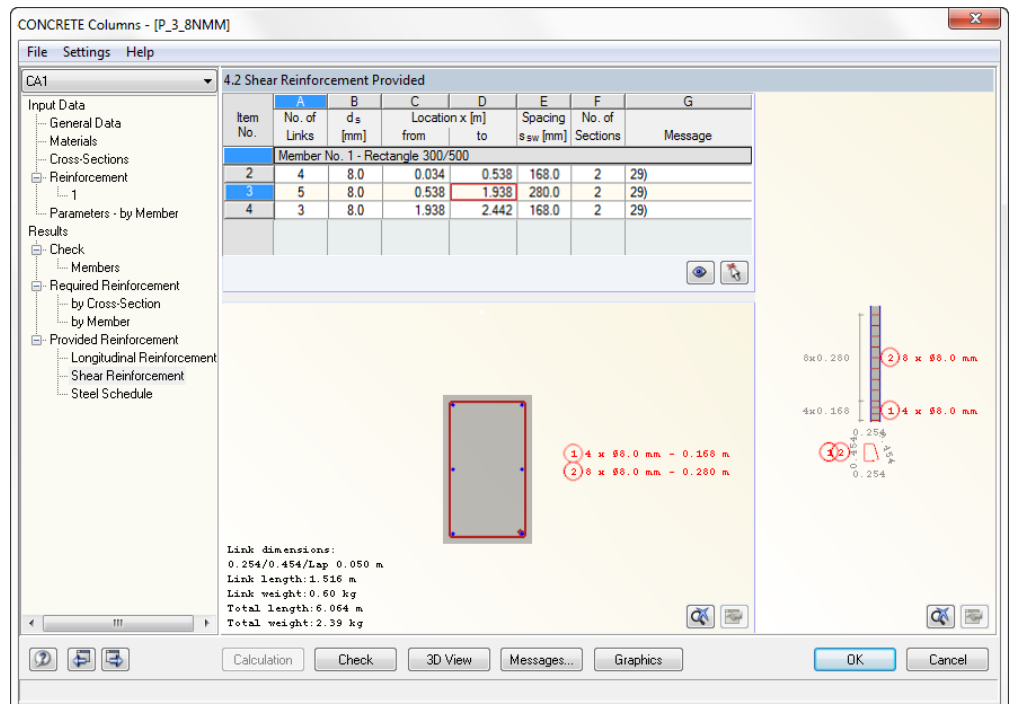


Figure 5.135: Window 4.2 Shear Reinforcement Provided

To undo this change, you can, for example, open the context menu by right-clicking in this column.

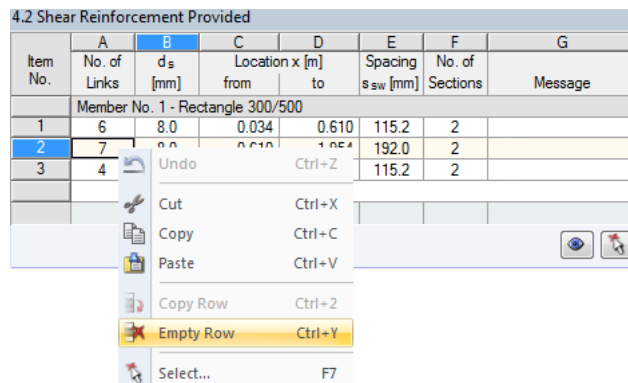


Figure 5.136: Context menu for deleting a position

If you select the *Empty Row* option from the context menu, item 5 disappears and the layout area of item 3 becomes adjacent to item 4 again.

To change an item, click [Edit shear reinforcement].

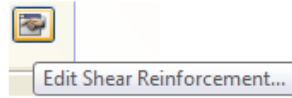


Figure 5.137: Button [Edit shear reinforcement]

In the following dialog box, you can modify not only the *x-locations* but also the *Spacing*, *Diameter*, and *Number of cuts* of the selected shear reinforcement.

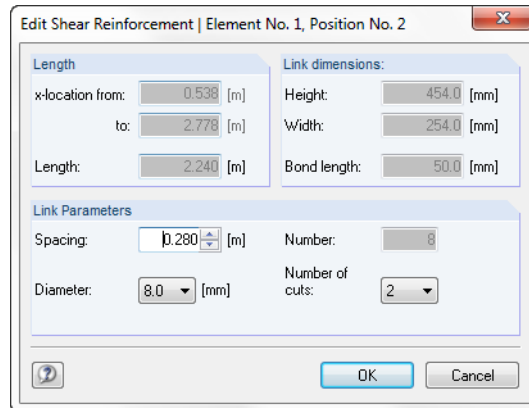


Figure 5.138: Dialog box *Edit Shear Reinforcement*

In each of the output windows 4.1 and 4.2 *Provided Reinforcement*, the [3D View] button is available at the bottom. To open a new window showing the longitudinal and shear reinforcement in a three-dimensional representation, click [3D View].

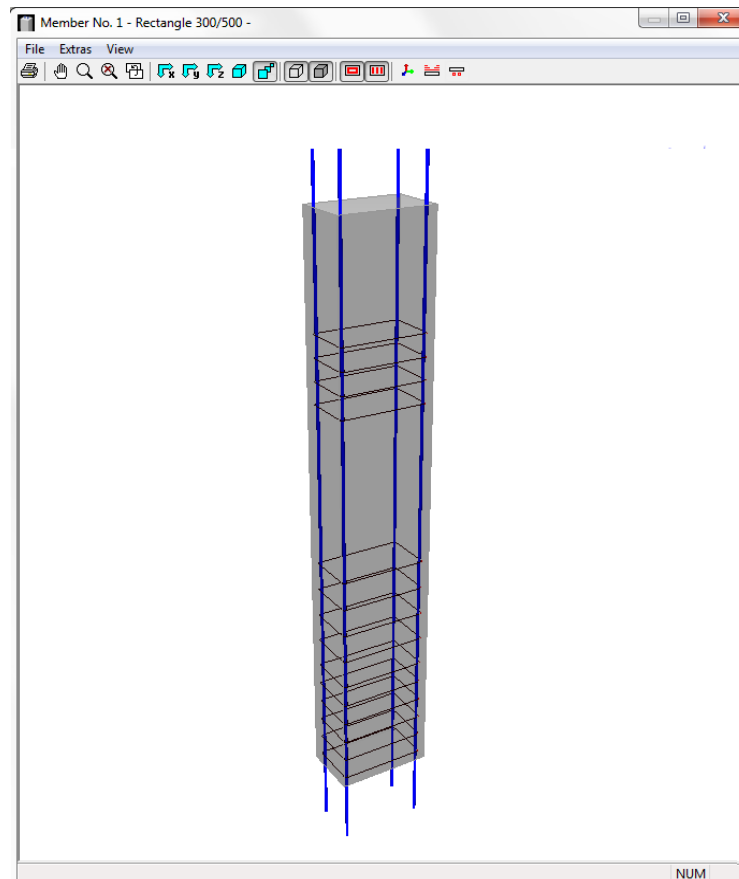


Figure 5.139: 3D view of reinforcement

The toolbar contains various buttons, which you can use to change the graphic.



Figure 5.140: Buttons

Click [Print] to open the following dialog box:

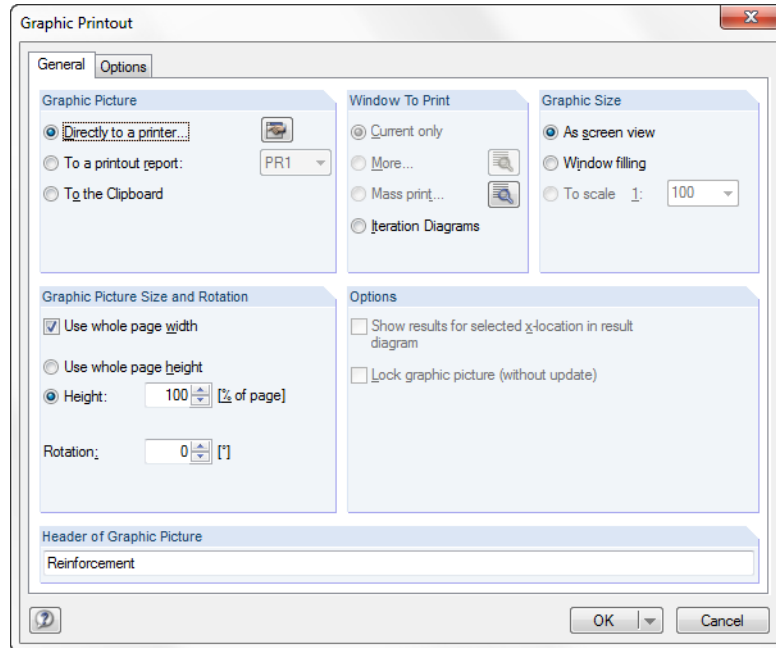


Figure 5.141: Dialog box *Graphic Printout*

As this common dialog box is already known from RSTAB, we will mention only the two options in the *Graphic Picture* here. In this section you can decide whether to print the 3D graphic directly or to transfer it to the printout report.

For each of the buttons in the 3D view window, there is context-sensitive help appearing when your mouse pointer rest on a button.

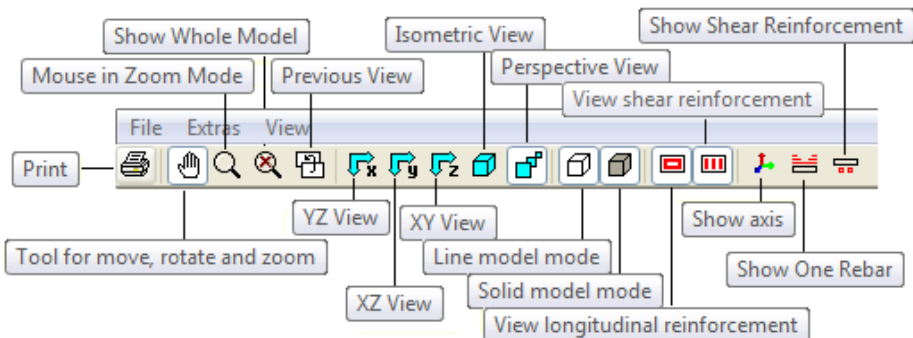


Figure 5.142: Context-sensitive help

To understand these functions better, try these buttons, and then observe the resulting changes in the graphical representation.

6. Results Evaluation

6.1 Results Display in RSTAB

To display the results as distribution at the selected columns, select the design case from the list in **CONCRETE Columns** first.

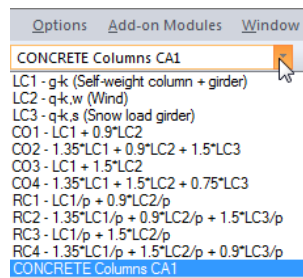


Figure 6.1: Selection of the design case of CONCRETE Columns

Furthermore, you have to ensure that the *Results* check box is selected in the *Display* navigator.

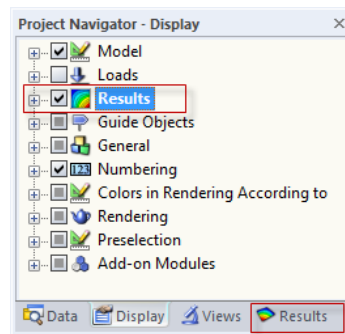


Figure 6.2: Display of results

Next, select the *Display* navigator.

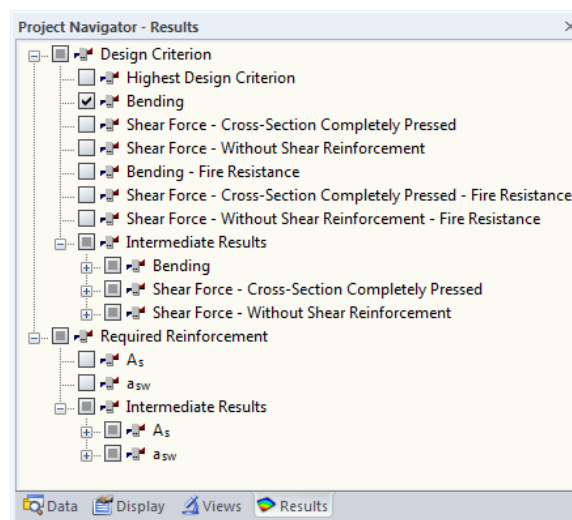


Figure 6.3: Results navigator

You can also display several types of results in the RSTAB work window. In the *Panel*, a color is assigned to the result that was selected for display in the navigator.

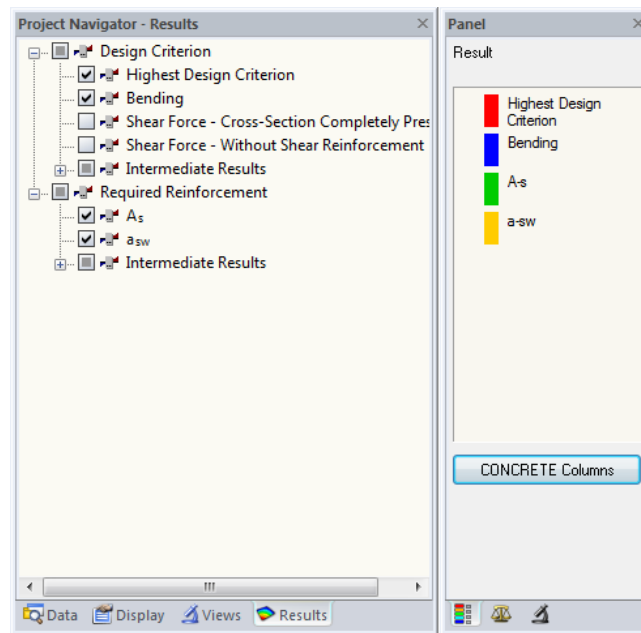


Figure 6.6: Relation of *Results* navigator and *Panel*

You can display up to eight different values as colored distributions.

In the middle tab of the control panel, a spin box is available for the member diagrams.

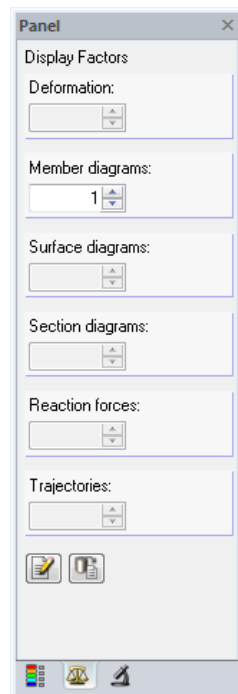


Figure 6.7: Control panel tab *Display Factors*

Here, you can adjust the scaling of the graphical value diagram.

In the last tab of the control panel, you can reduce the number of the displayed members.

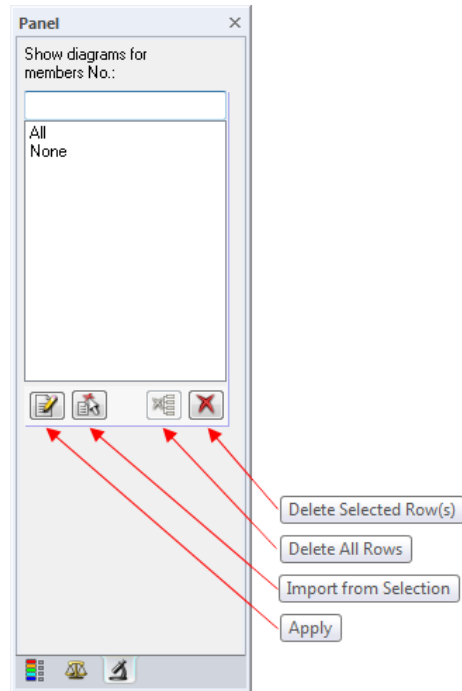


Figure 6.8: Control panel tab *Filter*

In the text field at the head of the list, you can enter the numbers of the members whose results diagrams you want to display. To apply your specification, click [Apply]. By doing this, the selected members are added to the list. The results diagrams will be shown only at the selected columns.

If one or several columns are already selected in the RSTAB work window, they can also be transferred by clicking [Import from selection].

To delete one, several, or all user-defined selection rows, click [Delete selected row(s)] or [Delete all rows].

6.2 Printout

There are three possibilities to open the printout report:

- [Current printout report] button in the toolbar.

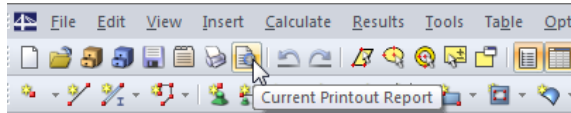


Figure 6.9: Button [Current printout report]

- Menu **File** → **Open Printout Report**

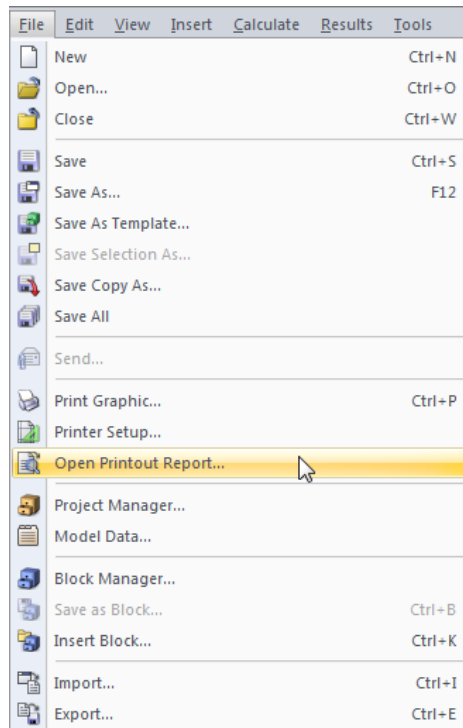


Figure 6.10: File → Open Printout Report

- Context menu *Printout Report* in *Data* navigator

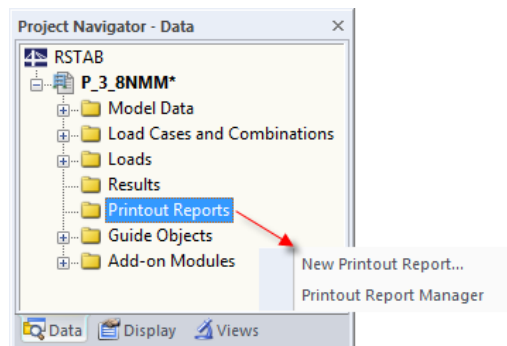


Figure 6.11: Context menu in *Data* navigator

To open this context menu, right-click the *Printout Reports* entry.

The following dialog box appears:

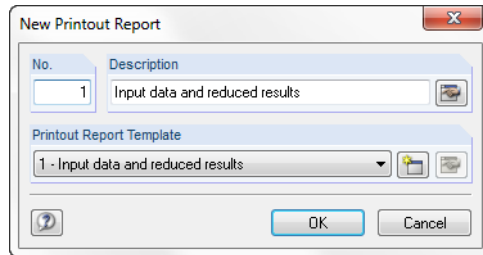


Figure 6.12: Dialog box *New Printout Report*

The number of the printout report is given automatically. However, it can be changed in the input field *No.* To facilitate the selection from the lists, you can add a *Description*. This description does not show up in the printout.

You can select a report template from the *Printout Report Template* drop-down list. The report templates are described in the RSTAB manual.

To preview the printout, click [OK]. The printout report includes all input and output data as shown in the module. The printout report will be displayed on the screen as shown in the following figure.

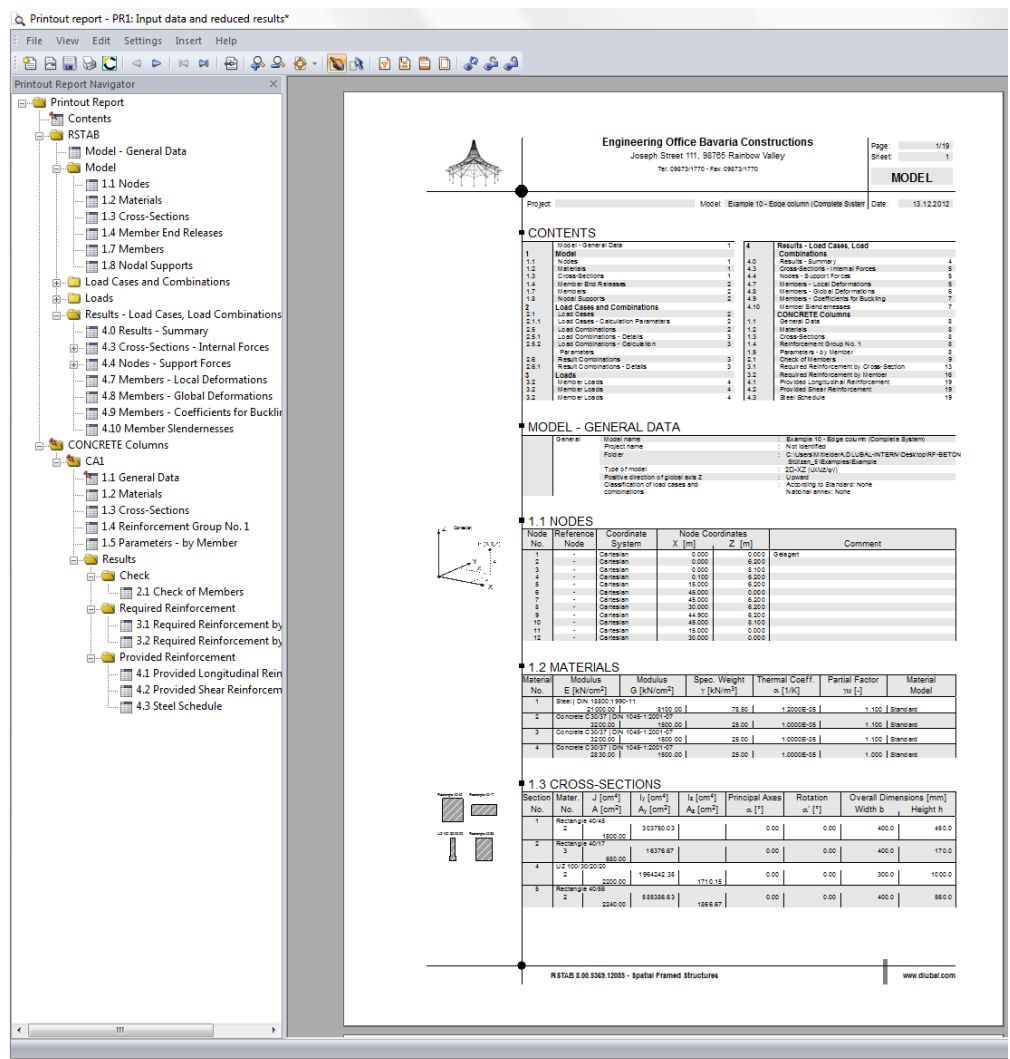


Figure 6.13: Printout report

The principles of the printout report are described in the RSTAB manual. Therefore, we will mention only the following issue here.

To select the data to be printed, click [Select Topics for Printout Report]:

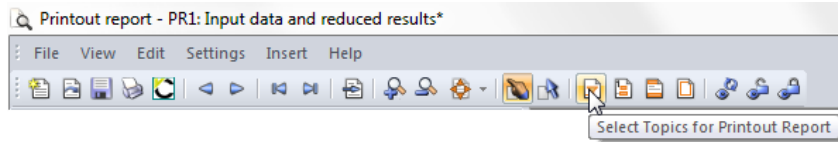


Figure 6.14: Button [Select topics for printout report]

The *Printout Report Selection* dialog box appears. On the left side of this dialog box, select the module whose input and output data you want to print.

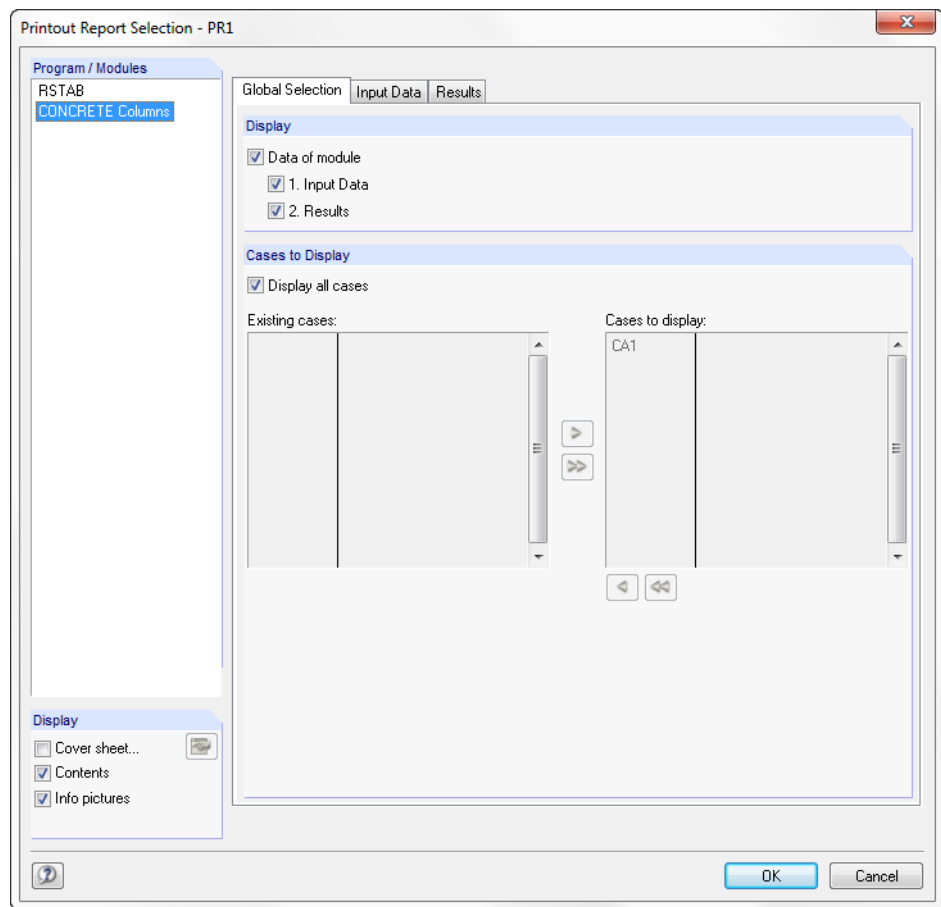


Figure 6.15: Dialog box *Printout Report Selection*, tab *Global Selection*

For the module **CONCRETE Columns**, the three tabs *Global Selection*, *Input Data*, and *Results* are shown.

In the *Global Selection* tab depicted above, there are three check boxes in the *Display* dialog box section. If you clear the selection of the *Data of the Module* check box, no data from this module will be shown in the printout report.

To display only the input data or the output data, clear the selection of the *Results* or *Input Data* check boxes, respectively.

In the *Cases to Display* dialog box section, you can select the results of the design cases that you want to include in the printout.

If you select the *Display all cases* check box, you will not be able to transfer the provided design cases from the left table to the right table of the design cases selected for display. Otherwise, you can use the two buttons to select one or several design cases for display.



Figure 6.16: Assigning design cases

If you select the *Input Data* tab, the *Printout Report Selection* dialog box will look as follows.

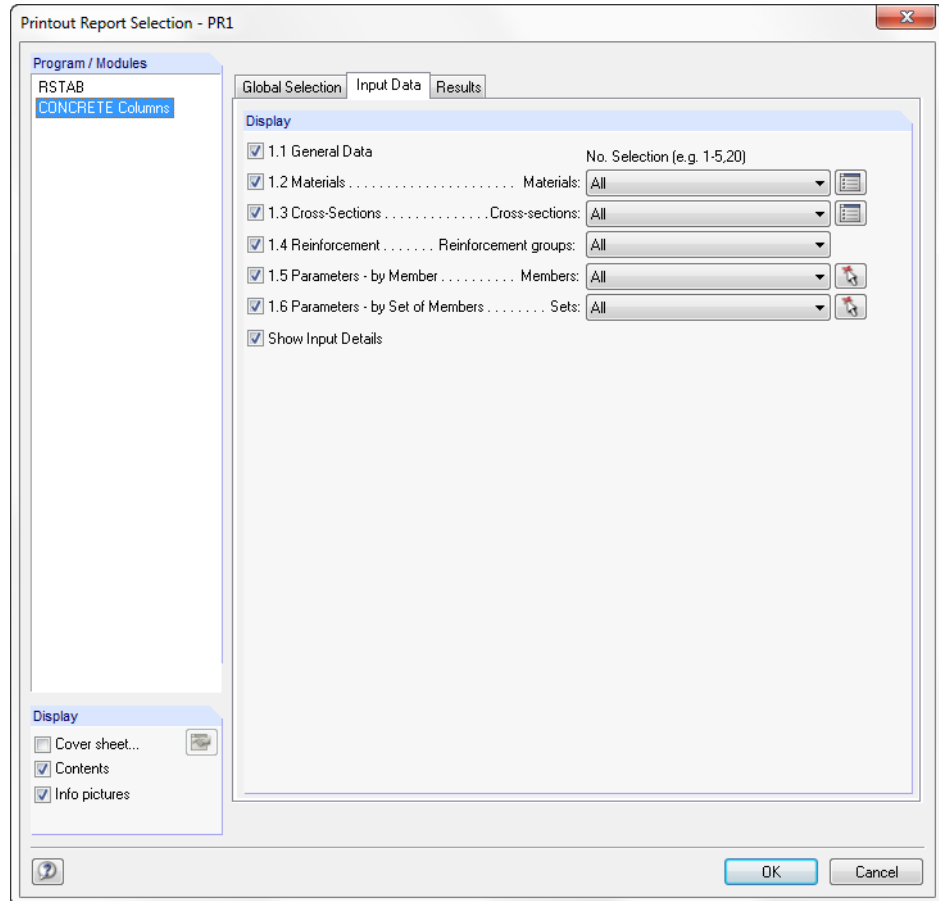


Figure 6.17: Dialog box *Printout Report Selection*, tab *Input Data*

In this tab, you decide by using the various check boxes on the left which input data from the various windows is to appear in the printout report.

Each of these input windows contains data sets that can be identified by a number. For example, different materials identifiable by a material number are shown in the 1.2 *Material* window. Material number(s) can be entered or selected in the input field of the same row. Thus, only the materials with this number appear in the printout report.

The same applies for the selection of cross-section numbers, numbers of reinforcement groups, and numbers of members and sets of members. Members or sets of members can be selected graphically by using the [Select] function in the RSTAB work window (see the following figure).



Figure 6.18: Selection of the members for the printout report

First, the selected members appear in the dialog box depicted in the figure above. Moreover, they are highlighted yellow in the structure. To transfer the numbers to the input field of the *Printout Report Selection*, click [OK].

In the last tab *Results* of the *Printout Report Selection*, you can define the output of the design results.

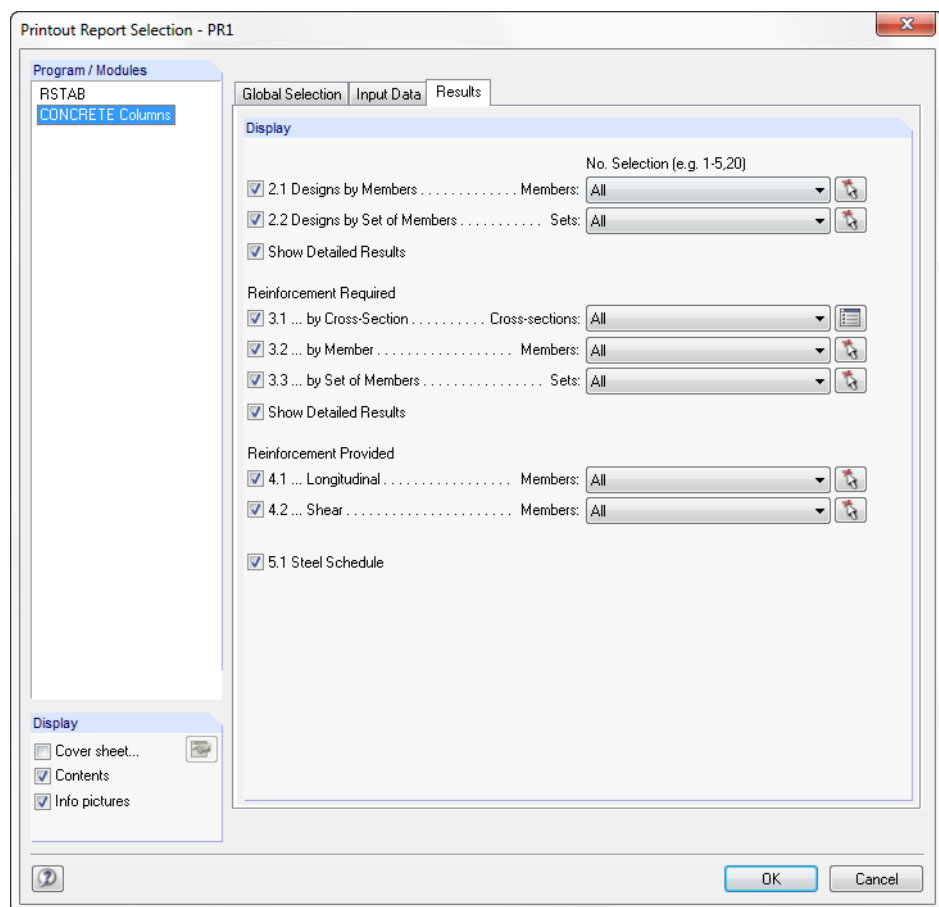


Figure 6.19: Dialog box *Printout Report Selection*, tab *Results*

The output control works as follows: Each row with a check box stands for an output window. If you clear the selection of a check box, the data of the corresponding output window will not be included in the printout report.

The results are presented by member, set of members, or cross-section. To further reduce the results, enter the number of the member, set of members, or cross-section in the respective input field at the end of the row.

To select certain members or sets of members not by entering numbers but by graphical selection, click the [Select] button.

7. Examples

7.1 Edge Column

7.1.1 System and Loads

We analyze a column according to EN 1992-1-1 (see [4], page 10-2). It is part of the following system.

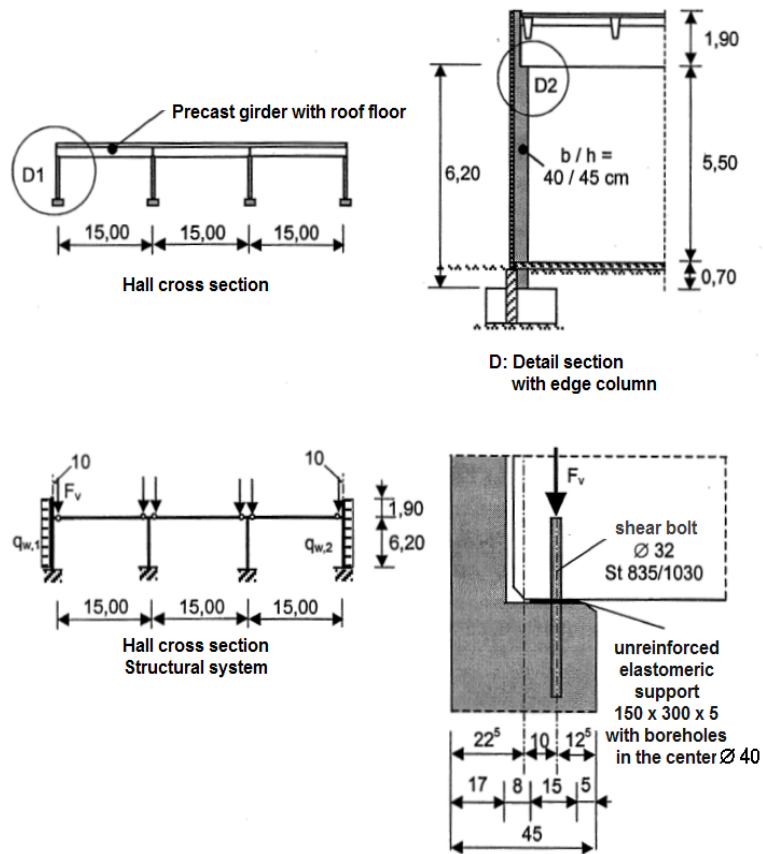


Figure 7.1: System

We generate the following loads in RSTAB:

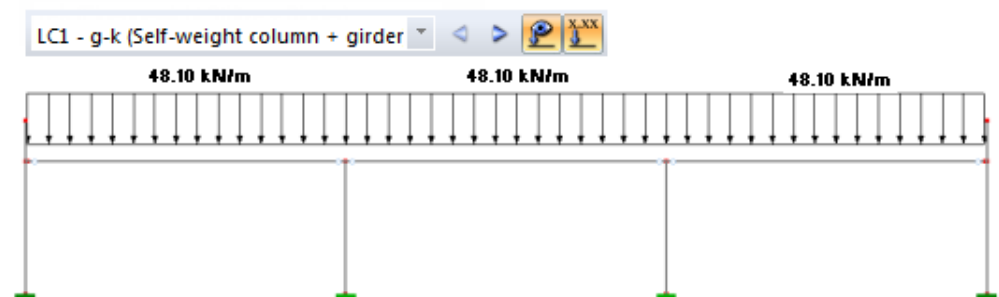


Figure 7.2: Load case 1: g-k (Self-weight column + girder)

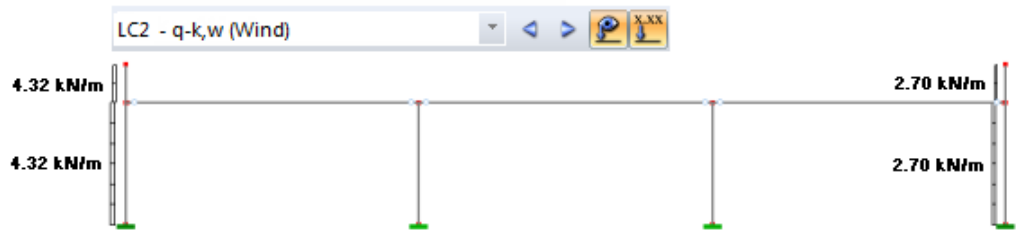


Figure 7.3: Load case 2: q-k,w (Wind)

Unlike in the literature, wind pressure and wind suction are combined in a load case.

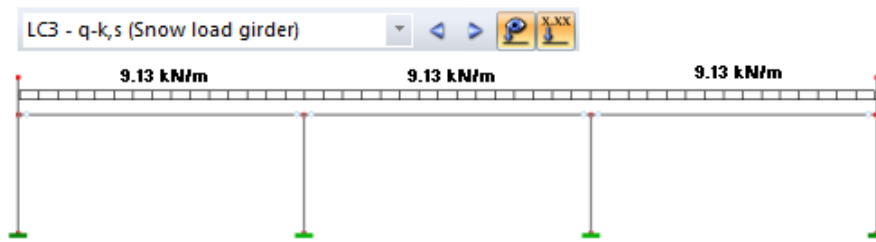


Figure 7.4: Load case 3: q-k,s (Snow load girder)

7.1.2 Design Values of Limit States

The partial safety factors in ultimate limit states are given as follows:

Loads	Favorable	Unfavorable
Permanent	$\gamma_G = 1.0$	$\gamma_G = 1.35$
Variable	$\gamma_Q = 0$	$\gamma_Q = 1.50$

The combination coefficients in the ultimate limit states are:

Loads	Favorable	Unfavorable
Permanent and variable	$\psi_{0,i} = 0.5$	$\psi_{0,i} = 0.6$

The general basic combination is expressed as:

$$G_d + Q_d = \gamma_G \cdot G_k + \gamma_{Q,1} \cdot Q_{k,1} + \sum \gamma_{Q,i} \cdot \psi_{0,i} \cdot Q_{k,i}$$

As shown in the literature used here, the governing distribution of internal forces results at the column to which the wind suction is applied. To determine the governing distribution of internal force, the load combinations C01, C02, C03, and C04 are created.

For these load combinations, different distributions of the internal forces N and M_y result along this column. As described in the theoretical part of this manual, the design is carried out for the locations of the minimum normal force N, the maximum bending moment M_y , and the minimum bending moment M_y .

In designing the selected load combinations C02, C03, and C03, the locations to be analyzed are therefore indicated by an arrow in the following paragraph.

1. Basic combination: leading action snow load $q_{k,s}$

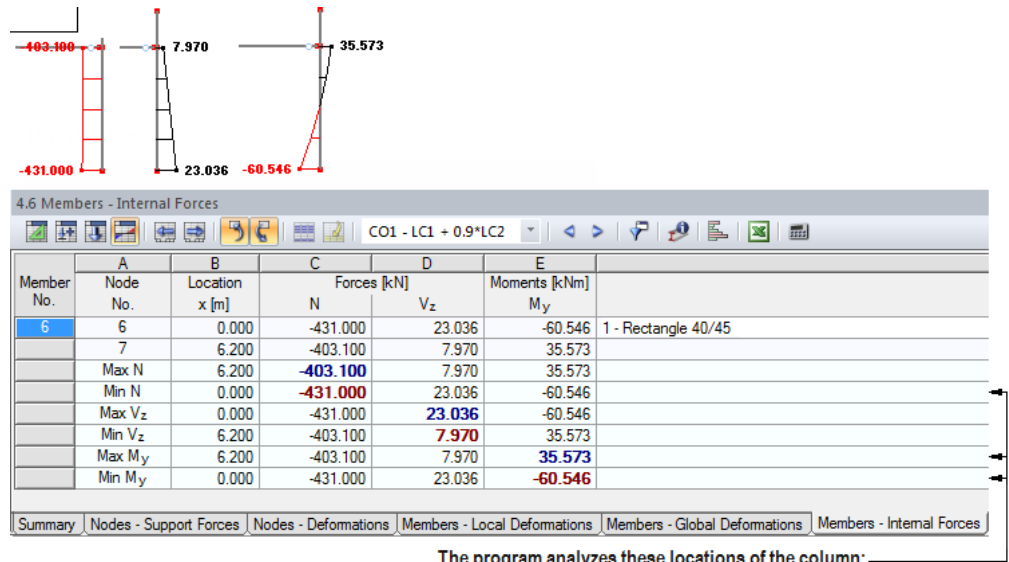
Favorable:

$$g_d = \gamma_G \cdot g_k = 1.0 \cdot g_k$$

$$q_{d,s} = \gamma_{Q,1} \cdot q_{k,s} = 0.0 \cdot q_{k,s} = 0$$

$$q_{d,w} = \sum \gamma_{Q,2} \cdot \psi_{0,2} \cdot q_{k,w} = 1.50 \cdot 0.6 \cdot q_{k,w} = 0.9 \cdot q_{k,w}$$

For the load combination CO1 created in RSTAB, the following distribution of internal forces results:



The program analyzes these locations of the column:

Figure 7.5: Results CO1

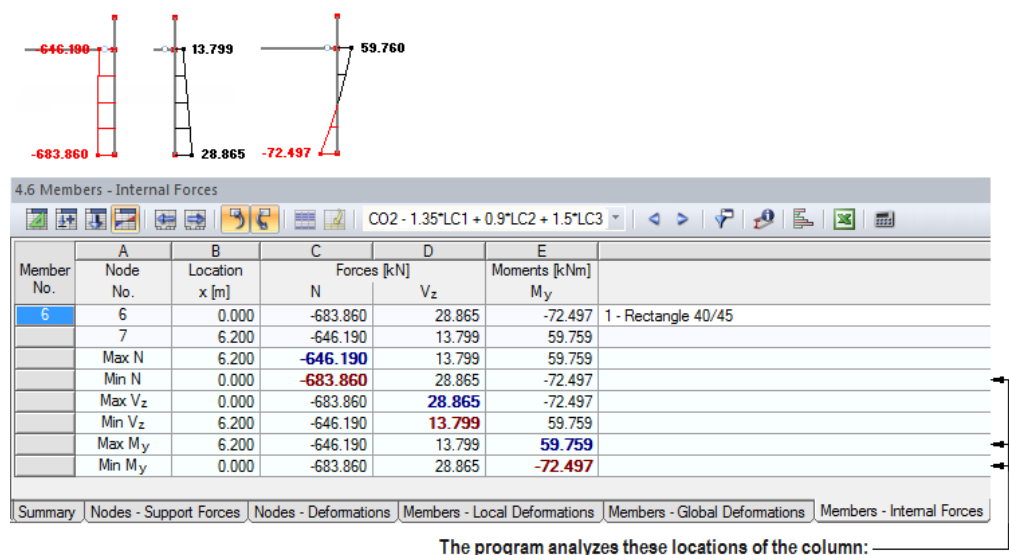
Unfavorable:

$$g_d = \gamma_G \cdot g_k = 1.5 \cdot g_k$$

$$q_{d,s} = \gamma_{Q,1} \cdot q_{k,s} = 1.50 \cdot q_{k,s} = 1.50 \cdot q_{k,s}$$

$$q_{d,w} = \sum \gamma_{Q,2} \cdot \psi_{0,2} \cdot q_{k,w} = 1.50 \cdot 0.6 \cdot q_{k,w} = 0.9 \cdot q_{k,w}$$

For the load combination CO2 created in RSTAB, the following distribution of internal forces results:



The program analyzes these locations of the column:

Figure 7.6: Results CO2

2. Basic combination: leading action wind

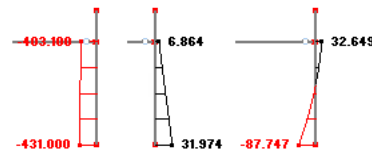
Favorable:

$$g_d = \gamma_G \cdot g_k = 1.0 \cdot g_k$$

$$q_{d,w} = \gamma_{Q,1} \cdot q_{k,w} = 1.50 \cdot q_{k,w} = 1.5 \cdot q_{k,w}$$

$$q_{d,s} = \sum \gamma_{Q,2} \cdot \psi_{0,2} \cdot q_{k,s} = 0.0 \cdot 0.5 \cdot q_{k,s} = 0.0$$

For the load combination CO3 created in RSTAB, the following distribution of internal forces results:



4.6 Members - Internal Forces

CO3 - LC1 + 1.5*LC2

Member No.	A		B		C		D		E	
	Node No.	Location x [m]	Forces [kN]		Moments [kNm]					
6	6	0.000	-431.000	31.974	-87.747	1 - Rectangle 40/45				
	7	6.200	-403.100	6.864	32.649					
	Max N	6.200	-403.100	6.864	32.649					
	Min N	0.000	-431.000	31.974	-87.747					
	Max Vz	0.000	-431.000	31.974	-87.747					
	Min Vz	6.200	-403.100	6.864	32.649					
	Max My	6.200	-403.100	6.864	32.649					
	Min My	0.000	-431.000	31.974	-87.747					

Summary Nodes - Support Forces Nodes - Deformations Members - Local Deformations Members - Global Deformations Members - Internal Forces

The program analyzes these locations of the column:

Figure 7.7: Results CO3

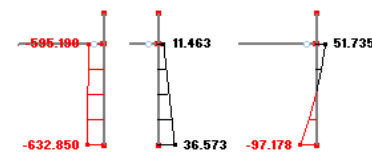
Unfavorable:

$$g_d = \gamma_G \cdot g_k = 1.35 \cdot g_k$$

$$q_{d,w} = \gamma_{Q,1} \cdot q_{k,w} = 1.50 \cdot q_{k,w} = 1.5 \cdot q_{k,w}$$

$$q_{d,s} = \sum \gamma_{Q,2} \cdot \psi_{0,2} \cdot q_{k,s} = 1.5 \cdot 0.5 \cdot q_{k,s} = 0.75 \cdot q_{k,s}$$

For the load combination CO4 created in RSTAB, the following distribution of internal forces results:



4.6 Members - Internal Forces

CO4 - 1.35*LC1 + 1.5*LC2 + 0.75*LC3

Member No.	A		B		C		D		E	
	Node No.	Location x [m]	Forces [kN]		Moments [kNm]					
6	6	0.000	-632.850	36.573	-97.177	1 - Rectangle 40/45				
	7	6.200	-595.190	11.463	51.734					
	Max N	6.200	-595.190	11.463	51.734					
	Min N	0.000	-632.850	36.573	-97.177					
	Max Vz	0.000	-632.850	36.573	-97.177					
	Min Vz	6.200	-595.190	11.463	51.734					
	Max My	6.200	-595.190	11.463	51.734					
	Min My	0.000	-632.850	36.573	-97.177					

Summary Nodes - Support Forces Nodes - Deformations Members - Local Deformations Members - Global Deformations Members - Internal Forces

The program analyzes these locations of the column:

Figure 7.8: Results CO4

In this connection, it is important to bear in mind during the creation of the load combination that you select the option of determining internal forces according to **First Order Theory**.

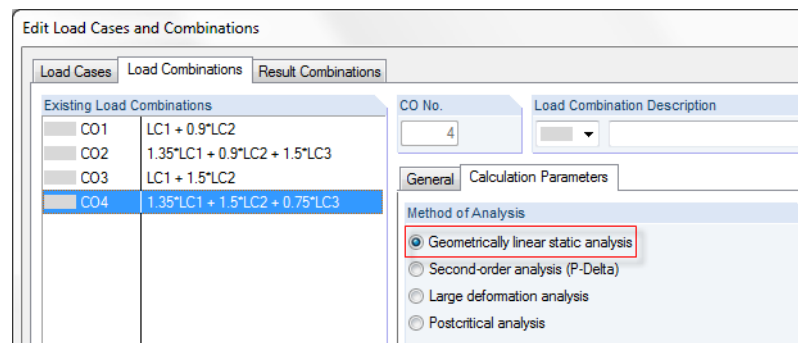


Figure 7.9: Calculation parameters – calculation according to geometrically linear static analysis

Thus, the load combinations CO2, CO3, and CO4 to be designed have been presented. Unlike in the example from the literature, not only the fixture point of the column is analyzed at which the internal force N and moment M_y are minimal. In addition to that, the location of the maximum moment M_y at the column head is analyzed, too. Next, we will determine the influence of the systematic analysis of the locations with maximum and minimum internal forces on the total verification of the column in comparison with the example from the literature.

Creep deformations must be considered in the design of slender compression elements if they unfavorably influence the stability of the structure. Therefore, the creep-producing moment due to quasi-permanent actions (= characteristic value of the permanent action g_k) at the footing of the column subjected to wind suction must be determined. Hence,

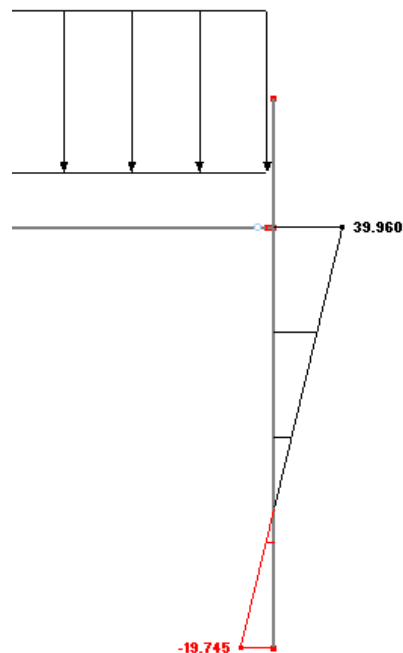


Figure 7.10: Creep-producing moment from LC1

7.1.3 Spatial Stiffness and Stability

The longitudinal direction of the hall runs in the longitudinal direction of the y-axis, the transversal direction of the hall runs in the direction of the z-axis of the relevant column. The stability in the longitudinal direction of the hall is ensured by other structural components.

Thus, the column can buckle about the axis y (that is, in the axis z = transversal direction of the hall), but not about the axis z (that is, in the axis y = longitudinal direction of the hall).

For this reason, the following settings are applied in the input window 1.5 *Column Parameters - by Member* for the respective direction:

Member No.	Length l [m]	Buckling About Axis y				Buckling About Axis z				Comment			
		Possible	Unbraced	Auto	$\beta_y [-]$	$l_{0,y} [m]$	$\lambda_y [-]$	Possible	Unbraced		Auto	$\beta_z [-]$	$l_{0,z} [m]$
6	6.200	<input checked="" type="checkbox"/>	<input checked="" type="checkbox"/>	<input type="checkbox"/>	2.100	13.020	100.2	<input type="checkbox"/>	<input type="checkbox"/>	<input type="checkbox"/>	-	-	-

Figure 7.11: Input in the window 1.5 *Column Parameters - by Members*

7.1.4 Effective Length and Slenderness

Effective length and slenderness are determined separately for both axes of the column.

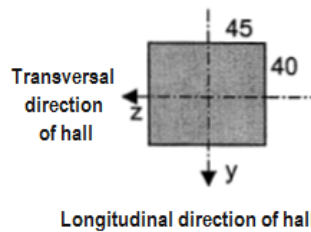


Figure 7.12: Axes of column

As mentioned in the previous paragraph, unlike in the literature, the index in the program always indicates the direction in which a possible buckling of the column is analyzed.

Effective length for bending about y-axis (in z-direction = transversal direction of the hall)

In the literature used here, the buckling length coefficient is estimated to be $\beta_z = 2.1$ for an elastically restrained cantilever column. We enter this value under the main entry *Effective Length* about axis y in the row *Determined Buckling Length Coefficient*.

Cross-Section		1 - Rectangle 40/45	
<input checked="" type="checkbox"/> General Properties			
<input checked="" type="checkbox"/> Effective Length			
<input checked="" type="checkbox"/> About axis y			
Determine Buckling Length Automatic:		Detm- β	<input type="checkbox"/>
Determined Buckling Coefficient		β_y	2.100
Effective Length		$l_{0,y}$	13.020 m

Figure 7.13: Effective length for bending about y-axis (in transversal direction of hall)

The system length $l_{col,y}$ for buckling corresponds to the column length $l_{col} = 6.20$ m between the idealized restrained locations.

Thus, you can determine the effective length $l_{0,y}$ for the buckling about the y-axis as follows:

$$l_{0,y} = \beta_y \cdot l_{col,y} = 2.1 \cdot 6,20 \text{ m} = 13.02 \text{ m}$$

The corresponding slenderness λ_y about the y-axis is determined as:

$$\lambda_y = \frac{l_{0,y}}{i_y} = \frac{1302}{12.99} = 100.23$$

This values can also be found in the details table of the output window.

Governing Load			
Effective Length According to 5.8.3.2			
Slenderness According to 5.8.3.2			
Slenderness About Axis y	λ_y	100.2280	
Effective Length	$l_{0,y}$	13.020	m
Radius of Gyration	i_y	129.9	mm

Figure 7.14: Slenderness for buckling about the y-axis (in the transversal direction of the hall)

Effective length for bending about z-axis (in y-direction = longitudinal direction of the hall)

A stability analysis in this direction is not carried out.

Cross-Section		1 - Rectangle 40/45	
General Properties			
About axis y			
About axis z			
Buckling Possible	Buckling.z		<input type="checkbox"/>
System Unbraced	Displace.z		<input type="checkbox"/>

Figure 7.15: Settings for bending about z-axis (in longitudinal direction of the hall)

Governing Load			
Effective Length According to 5.8.3.2			
Effective Length About Axis y	$l_{0,y}$	13.020	m
Effective Length About Axis z	$l_{0,z}$	6.200	m
No stability check in this direction according to user specification			
Slenderness According to 5.8.3.2			
Slenderness About Axis y	λ_y	100.2280	
Slenderness About Axis z	λ_z	0.0000	
No stability check in this direction according to user specification			

Figure 7.16: No stability analysis about the z-axis (longitudinal direction of hall)

7.1.5 Further Specifications in the Module

To complete the input, we present the selection of the loading and the specifications for the reinforcement.

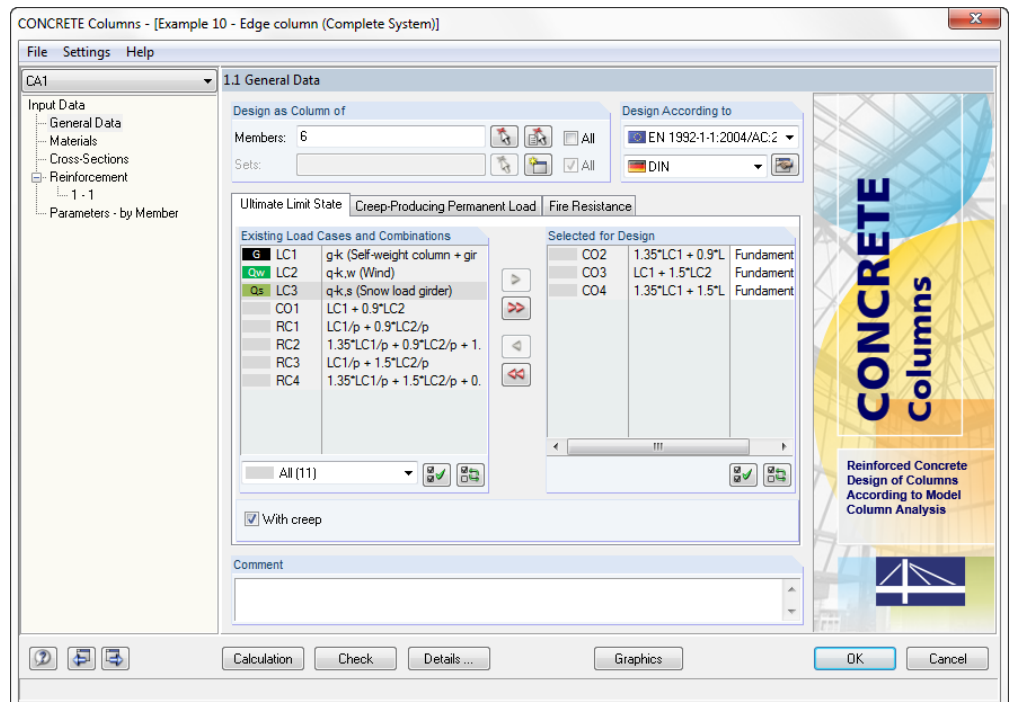


Figure 7.17: Selection of the loading in window 1.1 General Data, tab Ultimate Limit State

First, the load combinations selected in the *Ultimate Limit State* tab are analyzed individually. The reinforcement is determined for the governing load combination. With this reinforcement, the provided safety is determined for all load combinations selected here. Then, the complete check is shown for the load for which the smallest safety results.

We select the load that is resulting in the creep-producing permanent load in the second tab *Creep-Producing Permanent Load* of the 1.1 *General Data* window. For loads selected there, it is assumed that each single load acts permanently, however, none of them acts simultaneously. Therefore, the program analyzes for each of these loads if it results, together with the loads selected for the load bearing capacity, in the greatest reinforcement.

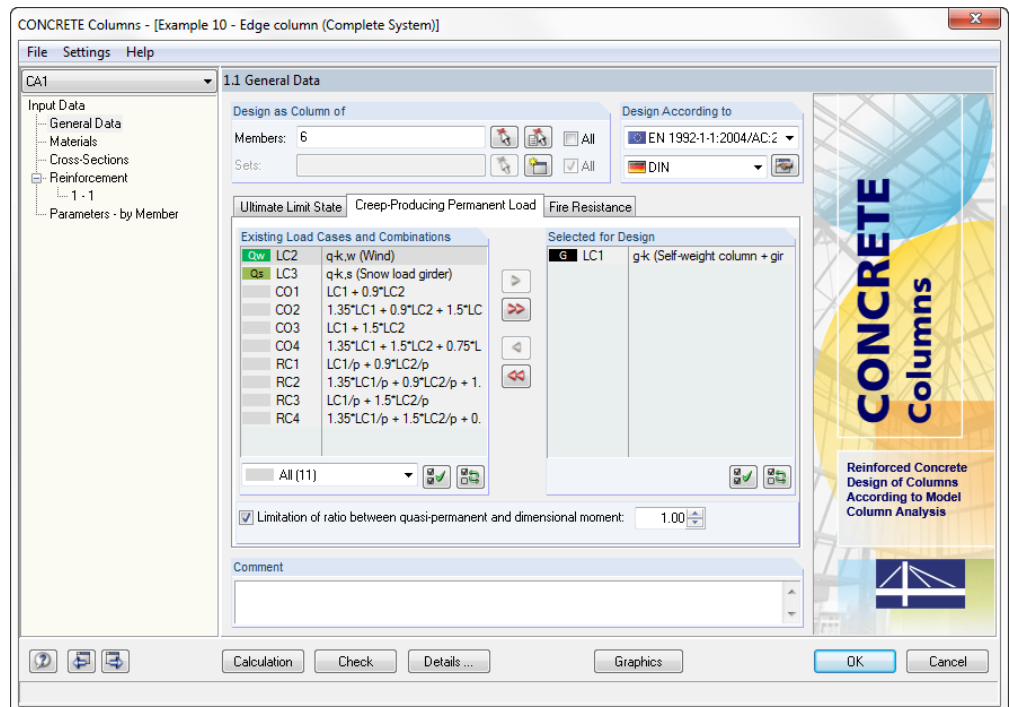


Figure 7.18: Selection of the load in window 1.1 *General Data*, tab *Creep-Producing Permanent Load*

The materials (concrete C30/37, B 500 S(B)) have already been defined in RSTAB during the creation of the structure. They are automatically imported in the module for the design of the column.

We specify the available rebar diameters for the *Longitudinal Reinforcement* in the 1.4 *Reinforcement* window.

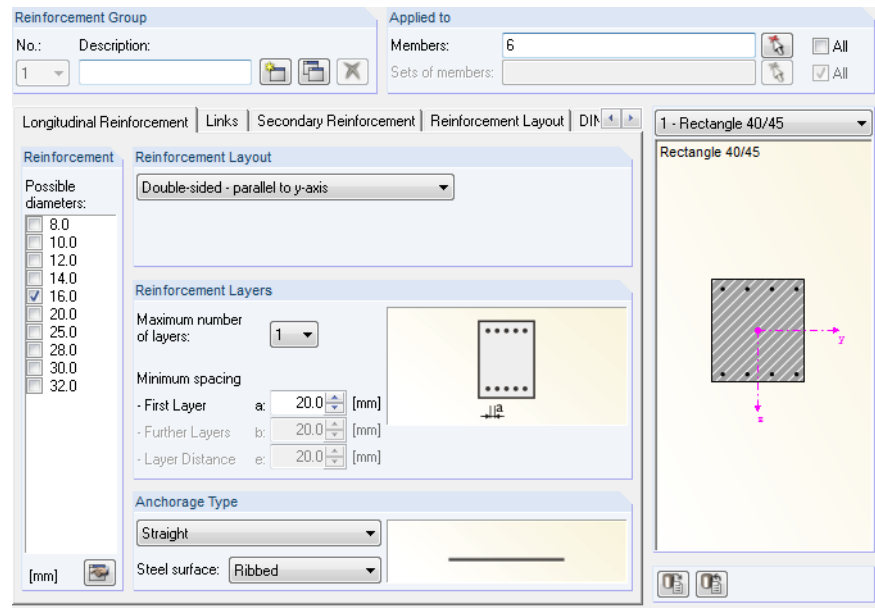


Figure 7.19: Selection in the reinforcement in table 1.4 *Reinforcement*, tab *Longitudinal Reinforcement*

Furthermore, we specify the layout of the reinforcement, the maximum number of reinforcement layers, and the anchorage type of the rebars in the *Longitudinal Reinforcement* tab of window 1.4.

Then, we specify the rebar diameter for the *Links*.

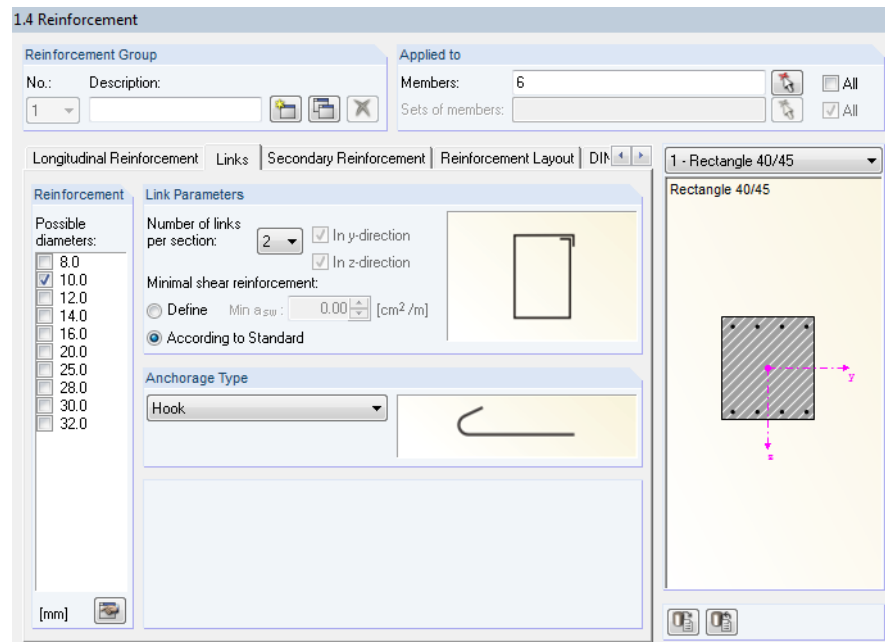


Figure 7.20: Selection of the links in window 1.4 *Reinforcement*, tab *Links*

In the *Secondary Reinforcement* tab we also specify that the maximum spacing of the rebars may not exceed 300 mm.

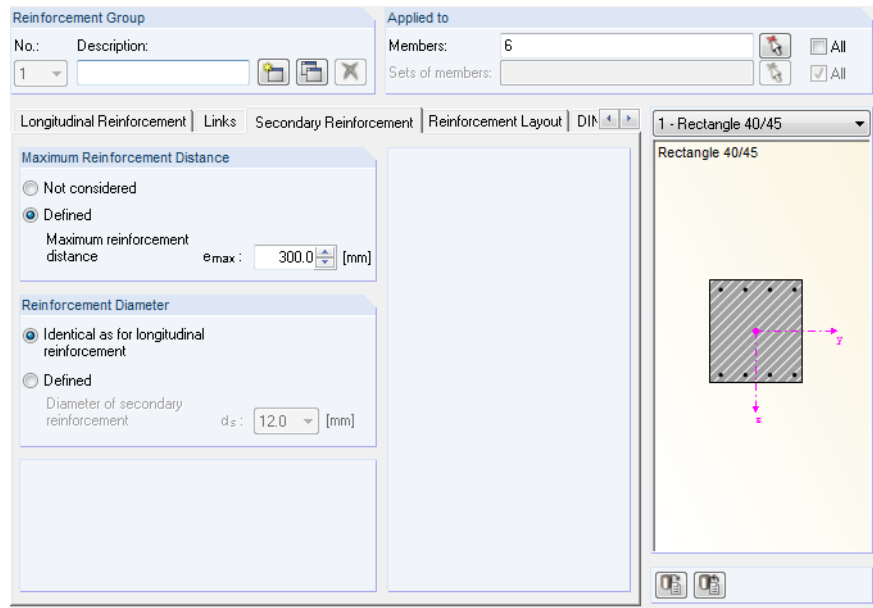


Figure 7.21: Specifications for secondary reinforcement in window 1.4 Reinforcement, tab Secondary Reinforcement

If the geometric result is a distance greater than 300 mm, the program defines an intermediate member. In addition to this, we specify in the *Secondary Reinforcement* tab that the diameter of the intermediate member is to be equal to the statically required reinforcement.

Next, we specify the concrete cover in the tab *Reinforcement* of window 1.4 to have an axial spacing of 38 mm.

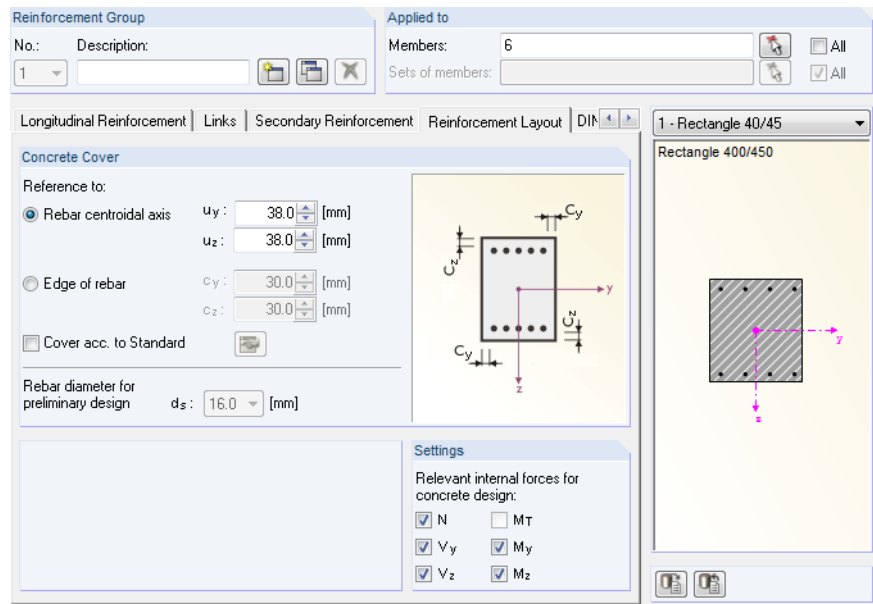


Figure 7.22: Selection of the concrete cover in window 1.4 Reinforcement, tab Reinforcement Layout

7.1.6 Required Reinforcement

Having entered the described parameters, we can start the calculation.

First, the program checks whether a standard design is sufficient or a stability analysis must be carried out. Next, the program calculates the required reinforcement and shows it in the upper tables of the windows 3.1 *Required Reinforcement by Cross-Section* and 3.2 *Required Reinforcement by Members*.

3.1 Required Reinforcement by Cross-Section							
Section No.	Reinforcement Type	Member No.	Position x [m]	LC / CO RC	Reinforcement		Error or Notice
					Area	Unit	
1	Rectangle 40/45						
	Longitudinal	6	0.000	CO4	A_s	15.54	cm ²
	Shear	6	-	-	a_{sw}	8.18	cm ² /m



All load cases  

Figure 7.23: *Required Reinforcement by Cross-Section*

The longitudinal reinforcement A_s of 15.54 cm² determined by the program differs from the value 16.20 cm² of the example from the literature. The reason for this difference is due to the value ω_{tot} . In the literature, this value was taken somewhat inaccurately from the diagram as 0.23. You can find all intermediate steps in the *Intermediate Results* table below. This details table starts with the name of the governing load.

Intermediate Results Rectangle 40/45 - CO4		
<input checked="" type="checkbox"/> Governing Load		
Load		CO4
Governing Internal Forces		min N
At Location	x	0.000 m
Normal Force	N	-632.850 kN
Moment About y-Axis	M_y	-97.177 kNm
Moment About z-Axis	M_z	0.000 kNm
<input checked="" type="checkbox"/> Effective Length According to 5.8.3.2		
<input checked="" type="checkbox"/> Slenderness According to 5.8.3.2		
<input checked="" type="checkbox"/> Limiting Slenderness According to 5.8.3.1 (1)		
<input checked="" type="checkbox"/> Design Type		
<input checked="" type="checkbox"/> Eccentricities		
<input checked="" type="checkbox"/> Moments According to First Order Theory		
<input checked="" type="checkbox"/> Moments According to Second Order Theory		
<input checked="" type="checkbox"/> Statically Required Reinforcement		
<input checked="" type="checkbox"/> Min. Reinforcement According to Standard		
<input checked="" type="checkbox"/> Required Reinforcement		

Figure 7.24: Table *Intermediate Results* for determination of the required reinforcement

As in the example from the literature, the governing load is the load combination CO4. The values used there are $N = -633$ kN and $M_y = 100$ kNm.

You can see that for CO4 a greater reinforcement results than for the rest of the load combinations if the following check box at the bottom of the window is selected:

All load cases

Figure 7.25: Display of the design results for all loads

Thus, the following table shows the reinforcement required for each load.

3.1 Required Reinforcement by Cross-Section								
Section No.	A	B	C	D	E	F	G	H
	Reinforcement Type	Member No.	Position x [m]	LC / CO RC	Reinforcement		Error or Notice	
					Area	Unit		
1	Rectangle 40/45							
	Longitudinal	6	0.000	CO2	A_s	13.17	cm ²	
	Shear	6	-	-	a_{sw}	8.18	cm ² /m	
1	Rectangle 40/45							
	Longitudinal	6	0.000	CO3	A_s	12.41	cm ²	
	Shear	6	-	-	a_{sw}	8.18	cm ² /m	
1	Rectangle 40/45							
	Longitudinal	6	0.000	CO4	A_s	15.54	cm ²	
	Shear	6	-	-	a_{sw}	8.18	cm ² /m	

All load cases

Figure 7.26: Required reinforcement for all loads

To compare, the literature gives for CO2 $A_s = 13.4 \text{ cm}^2$, for CO3 $A_s = 1.7 \text{ cm}^2$, and for CO4 $A_s = 16.2 \text{ cm}^2$.

The effective lengths and slendernesses, already determined by entering the specifications in the *Column Parameters* input window, can also be found for the complete design output in the corresponding main entries of these intermediate results.

Intermediate Results Rectangle 40/45 - CO4		
Governing Load		
Effective Length According to 5.8.3.2		
<input type="checkbox"/> Effective Length About Axis y	$l_{0,y}$	13.020 m
Column Length	l_y	6.200 m
Buckling Coefficient	β_y	2.100
<input type="checkbox"/> Effective Length About Axis z	$l_{0,z}$	6.200 m
No stability check in this direction according to user specification		
Slenderness According to 5.8.3.2		
<input type="checkbox"/> Slenderness About Axis y	λ_y	100.2280
Effective Length	$l_{0,y}$	13.020 m
Radius of Gyration	i_y	129.9 mm
<input type="checkbox"/> Slenderness About Axis z	λ_z	0.0000
No stability check in this direction according to user specification		

Figure 7.27: Effective Length and Slenderness

7.1.7 Limiting Slenderness

The internal forces of the minimum axial force have the following intermediate results in the determination of the limiting slenderness:

Intermediate Results Rectangle 40/45 - CO2			
Limiting Slenderness According to 5.8.3.1 (1)			
Relative Normal Force	n	0.2235	< 0.41
Normal Force	N _{Ed}	-683.860	kN
Area of Cross-Section	A _c	1800.00	cm ²
Design Value of Concrete Compr. Strength	f _{ed}	17.00	N/mm ²
Char. Concrete Compressive Strength	f _{ck}	30.00	N/mm ²
Reduction Factor	α	0.8500	
Partial Safety Factor for Concrete	γ _c	1.5000	
Limiting Slenderness About Axis y	λ _{lim,y}	33.8452	
Limiting Slenderness About Axis z	λ _{lim,z}	33.8452	
Intermediate Results Rectangle 40/45 - CO3			
Limiting Slenderness According to 5.8.3.1 (1)			
Relative Normal Force	n	0.1408	< 0.41
Normal Force	N _{Ed}	-431.000	kN
Area of Cross-Section	A _c	1800.00	cm ²
Design Value of Concrete Compr. Strength	f _{ed}	17.00	N/mm ²
Char. Concrete Compressive Strength	f _{ck}	30.00	N/mm ²
Reduction Factor	α	0.8500	
Partial Safety Factor for Concrete	γ _c	1.5000	
Limiting Slenderness About Axis y	λ _{lim,y}	42.6326	
Limiting Slenderness About Axis z	λ _{lim,z}	42.6326	
Intermediate Results Rectangle 40/45 - CO4			
Limiting Slenderness According to 5.8.3.1 (1)			
Relative Normal Force	n	0.2068	< 0.41
Normal Force	N _{Ed}	-632.850	kN
Area of Cross-Section	A _c	1800.00	cm ²
Design Value of Concrete Compr. Strength	f _{ed}	17.00	N/mm ²
Char. Concrete Compressive Strength	f _{ck}	30.00	N/mm ²
Reduction Factor	α	0.8500	
Partial Safety Factor for Concrete	γ _c	1.5000	
Limiting Slenderness About Axis y	λ _{lim,y}	35.1828	
Limiting Slenderness About Axis z	λ _{lim,z}	35.1828	

Figure 7.28: Limiting slenderness for CO2, CO3, and CO4

The slenderness λ_y about the y-axis has the value 100.23 and is, therefore, greater than the load case-related limiting slendernesses. Therefore, according to 8.6.2 (4), a stability analysis must be performed for each of the presented loads.

Intermediate Results Rectangle 40/45 - CO4			
Design Type			
Conditions of standard design according to 5.8.3.1 (1)			
Condition About Axis y	$\lambda_y \leq \lambda_{lim,y}$	Failed	
Slenderness Provided	λ_y	100.2280	
Limiting Slenderness About Axis y	$\lambda_{lim,y}$	35.1828	
Condition About Axis z	$\lambda_z \leq \lambda_{lim,z}$	Passed	
No stability check in this direction according to user specification			
Condition of standard design fulfilled?		Failed	
Conditions of standard design according to 5.8.3.1 (1)			
Normal force is not a compressive force?		No	
Condition of standard design fulfilled?		No	
Stability Check Required			

Figure 7.29: Design Type

7.1.8 Eccentricities

The intended eccentricity, the eccentricity due to imperfection, and the minimum eccentricity are calculated and presented according to DIN EN 1992-1-1.

Eccentricities		
Intended Eccentricity According to 5.8.8.2		
Intended Eccentricity in z-direction	$e_{0,z}$	-153.6 mm
Moment Diagram Along the Support	Diagram M_y	Different
Moment About Axis y	M_y	-97.177 kNm
Absolute Normal Force	$ N $	632.850 kN
Intended Eccentricity in y-direction	$e_{0,y}$	0.0 mm
Eccentricity due to imperfection according to 5.2		
Eccentricity Due to Imperfection in z-direction	$e_{i,z}$	-26.1 mm
Inclination	$\theta_{i,z}$	0.0040
Basic Value of Inclination	θ_0	0.0040
Column Length	l_y	6.200 m
Reduction Factor for Column Number	α_m	1.0000
According to user specification, the column will be designed as a single column.		
Buckling Length	$l_{0,y}$	13.020 m
Eccentricity Due to Imperfection in y-direction	$e_{i,y}$	0.0 mm
Minimum Eccentricity According to 6.1 (4)		
Minimum Eccentricity in z-direction	$e_{min,z}$	-20.0 mm
Thickness of Structural Member	$h_{w,z}$	450.0 mm
Minimum Value of Minimum Eccentricity	$e_{20\text{ mm},z}$	20.0 mm
Minimum Eccentricity in y-direction	$e_{min,y}$	0.0 mm

Figure 7.30: Eccentricities for CO4

With the intended eccentricity and the eccentricity due to imperfection, the first order moments can be determined.

7.1.9 Moments According to First Order Theory

Internal forces of the minimum axial force at the column footing (location $x = 0.00$ m)

The first order moment about the y-axis due to eccentricity in the z-direction (transversal direction of the hall) is, respectively:

	CO2	CO3	CO4
N_{Ed}	-683.860 kN	-431.000 kN	-632.850 kN
$e_{0,z}$	-10.60 cm	-20.36 cm	-15.36 cm
$e_{i,z}$	-2.61 cm		
$M_{Ed,1,y}$	-90.37 kNm	-99.02 kNm	-113.72 kNm

At the governing location of the column footing, the following details are shown for the internal forces of the minimum axial force in the CO4:

Intermediate Results Rectangle 40/45 - CO4			
Moments According to First Order Theory			
Moments According to First Order Theory			
Design Normal Force	N_{Ed}	-632.850	kN
Moment About Axis y	$M_{Ed,1,y}$	-113.723	kNm
Calculated Total Eccentricity in z-Direction			
Intended Eccentricity	$e_{0,z}$	-153.6	mm
Eccentricity Due to Imperfection	$e_{i,z}$	-26.1	mm
Moment About Axis z	$M_{Ed,1,z}$	0.000	kNm
No buckling risk according to user specifications			

Figure 7.31: First order moments for CO4

7.1.10 Second order moments

Internal forces of the minimum axial force at the column footing (location $x = 0.00$ m)

The second order moment about the y-axis due to eccentricities in z-direction (transversal direction of the hall) is, respectively:

	CO2	CO3	CO4
N_{Ed}	-683.860 kN	-431.000 kN	-632.850 kN
$e_{2,tot,z}$	-33.09 cm	-42.85 cm	-37.85 cm
$M_{Ed,y2}$	-226.308 kNm	-184.686 kNm	-239.52 kNm

At the governing location of the column footing, the following details are shown for the internal forces of the minimum axial force in the CO4:

Intermediate Results Rectangle 40/45 - CO4			
<input checked="" type="checkbox"/> Moments According to Second Order Theory			
<input type="checkbox"/> Eccentricity Through Second Ord. Th. According to 5.8.8.2(3)			
<input type="checkbox"/> Eccentricity Through Second Order Thec	$e_{2,z}$	-198.8	mm
<input type="checkbox"/> Coefficient	$k_{1,z}$	1.0000	
<input type="checkbox"/> Slenderness About Axis y	λ_y	100.2280	
<input type="checkbox"/> Curvature in z-plane	$1/r_z$	0.012	1/m
<input type="checkbox"/> Selected Factor (Normal Force)	sel $K_{r,z}$	1.0000	
<input type="checkbox"/> Calculated Factor (Normal Force)	$K_{r,z}$	1.2354	
<input type="checkbox"/> Max. Ultimate Limit State	n_u	1.2208	
<input type="checkbox"/> Ratio	ω	0.2208	
<input checked="" type="checkbox"/> Provided Reinforcement	prov A_s	15.54	cm ²
<input type="checkbox"/> Design Value of Yield Stre	f_{yd}	434.78	N/mm ²
<input type="checkbox"/> Area of Cross-Section	A_c	1800.00	cm ²
<input type="checkbox"/> Design Value of Concrete	f_{cd}	17.00	N/mm ²
<input checked="" type="checkbox"/> Relative Normal Force	n	-0.2068	
<input type="checkbox"/> Resistant Concrete Normal Fon	n_{bal}	-0.4000	
<input checked="" type="checkbox"/> Selected Factor (Creep)	sel $K_{\phi,z}$	1.0000	
<input checked="" type="checkbox"/> Curvature in z-plane	$1/r_{0,z}$	0.012	1/m
<input type="checkbox"/> Buckling Length	$l_{0,y}$	13.020	m
<input type="checkbox"/> Factor (Curvature Distribution)	c	9.8696	
<input type="checkbox"/> Eccentricity Through Second Order Thec	$e_{2,y}$	0.0	mm
<input checked="" type="checkbox"/> Moments According to Second Order Theory			

Figure 7.32: Second order eccentricity in z-direction (CO4)

Intermediate Results Rectangle 40/45 - CO4			
<input checked="" type="checkbox"/> Moments According to Second Order Theory			
<input checked="" type="checkbox"/> Eccentricity Through Second Ord. Th. According to 5.8.8.2(3)			
<input checked="" type="checkbox"/> Moments According to Second Order Theory			
<input type="checkbox"/> Design Normal Force	N_{Ed}	-632.850	kN
<input type="checkbox"/> Moment About Axis y	$M_{Ed,y2}$	-239.515	kNm
<input checked="" type="checkbox"/> Total Eccentricity in z-direction	$e_{2,tot,z}$	-378.5	mm
<input type="checkbox"/> Eccentricity Through Second Ord. T	$e_{2,z}$	-198.8	mm
<input checked="" type="checkbox"/> Eccentricity (First Ord. Th.) in z-direc	$e_{1,z}$	-179.7	mm
<input checked="" type="checkbox"/> Minimum Eccentricity in z-direction	$e_{min,z}$	-20.0	mm
<input checked="" type="checkbox"/> Moment About Axis z	$M_{Ed,z2}$	0.000	kNm

Figure 7.33: Second order moments in z-direction (CO4)

7.1.11 Statically Required Reinforcement

Intermediate Results Rectangle 40/45 - C04			
Statically Required Reinforcement			
Design Internal Forces			
Normal Force	N_{Ed}	-632.850	kN
Moment About y-Axis Due to Second Ord	$M_{Ed,y2}$	-239.515	kNm
Moment About z-Axis Due to Second Ord	$M_{Ed,z2}$	0.000	kNm
Curvatures			
Points of Cross-Section			
Rebars			
Statically Required Reinforcement	$req A_{s,stat}$	15.54	cm ²
Min. Reinforcement According to Standard			
1st Minimum Reinforcement			
Design Normal Force	N_{Ed}	-632.850	kN
Design Value of Yield Stress	f_{yd}	434.78	N/mm ²
Min. Reinforcement	$req A_{s,min,1}$	2.18	cm ²
2nd Minimum Reinforcement			
Area of Cross-Section	A_c	1800.00	cm ²
Min. Reinforcement	$req A_{s,min,2}$	5.40	cm ²
Minimum Reinforcement Acc. to Standard	$req A_{s,min,Stand}$	5.40	cm ²
Required Reinforcement			
Statically Required Reinforcement	$req A_{s,stat}$	15.54	cm ²
Minimum Reinforcement Acc. to Standard	$req A_{s,min,Stand}$	5.40	cm ²
Required Reinforcement	$req A_s$	15.54	cm ²

Figure 7.34: Intermediate results

Now, we must determine a *provided reinforcement* for this *required reinforcement*.

7.1.12 Provided Reinforcement

According to EN 1992-1-1, 9.5.2(3), the entire reinforcement cross-section may not exceed the maximum allowed value of $0.09 A_c$:

$$A_{s,max} = 0.09 \cdot A_c = 0.09 \cdot 1800 \text{ cm}^2 = 162 \text{ cm}^2$$

To obtain the same results as in the example from the literature, only the reinforcement steel with a diameter of 16 mm was allowed by user-definition.

With these rebars, the program searches for the most economical solution. The provided reinforcement area should be greater than and come as close as possible to the required reinforcement area of 15.54 cm^2 .

For each side, four rebars with a bar diameter of 16 mm are arranged parallel to the y-axis of the cross-section in the longitudinal direction of the hall.

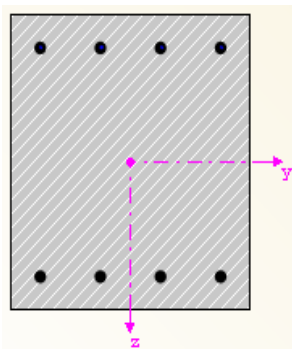


Figure 7.35: Selected longitudinal reinforcement

Clause 9.5.2(4) of EN 1992-1-1 states that the maximum longitudinal distance of the polygonal cross-sections may not be greater than 300 mm. Therefore, a secondary intermediate rebar with a diameter of at least 12 mm must be inserted at both sides parallel to the z-axis. However, as we did not provide the diameter to the program, the program selects a bar with a diameter of 16 mm.

The maximum distance was specified as 300 mm in the 1.4 *Secondary Reinforcement* window.

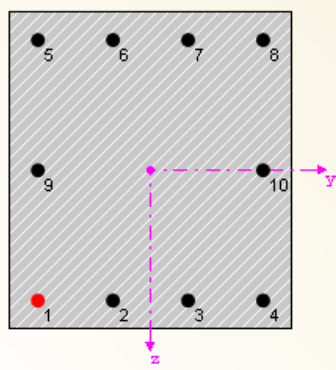


Figure 7.36: Selected longitudinal reinforcement with secondary reinforcement

This secondary reinforcement is also used in determining the provided safety.

7.1.13 Provided Safety

In the 2.1 *Check of Members*, window the following provided safety against failure is obtained for CO4.

	CO4
γ	1.1128

We can obtain a different safety, if we change the longitudinal reinforcement in the 4.1 *Longitudinal Reinforcement Provided* window.

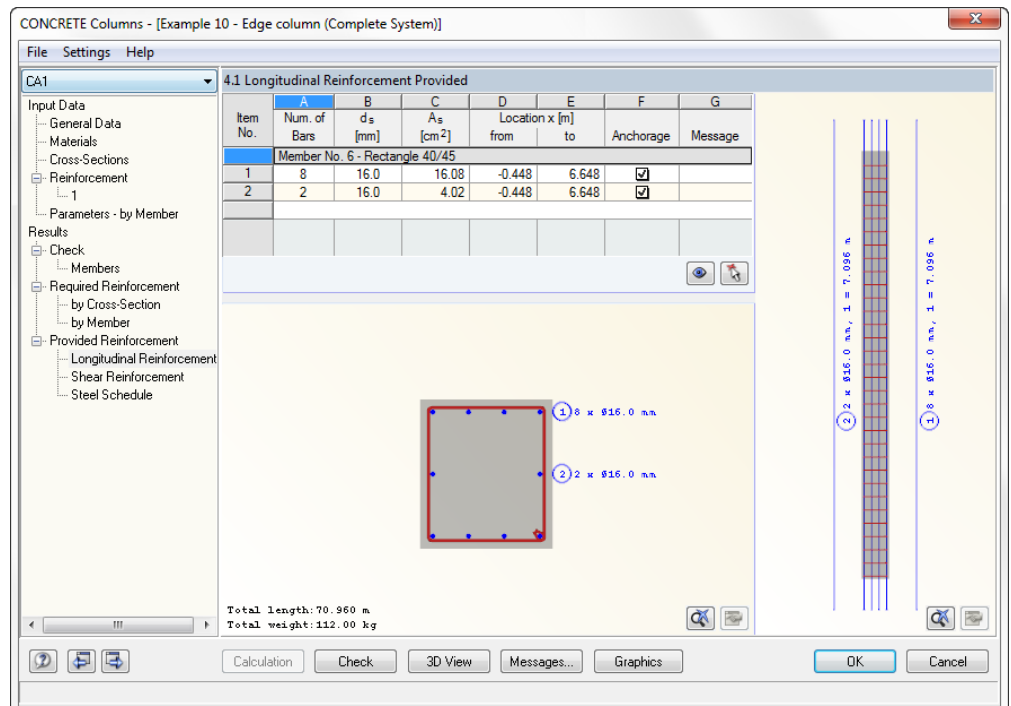


Figure 7.37: Window 4.1 *Longitudinal Reinforcement Provided*

The upper table shows two items for the column: *Item 1* is the statically required reinforcement. *Item 2* is the secondary reinforcement. The latter is necessary to prevent the distance between two rebars becoming greater than 300 mm. To select item 2, we click it. To edit this item, we click [Edit].

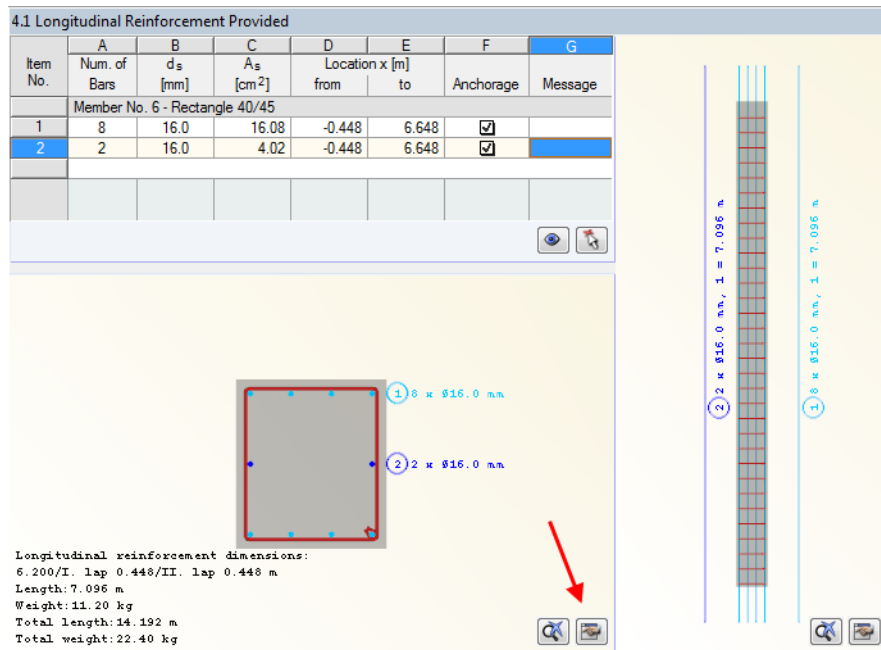


Figure 7.38: Modifying an item via the [Edit] button

The following dialog box appears:

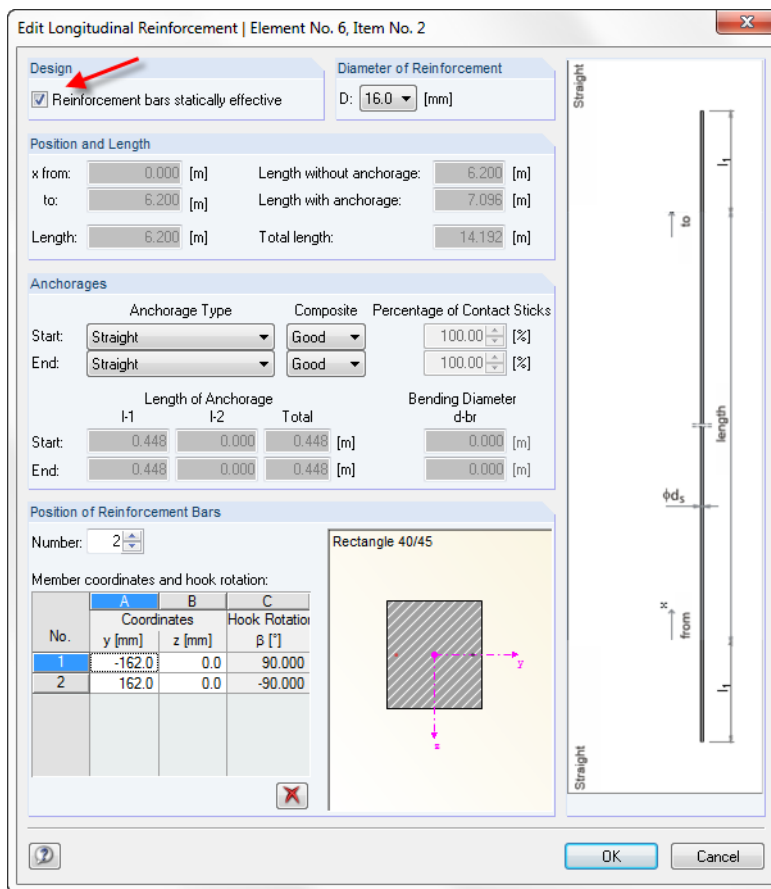


Figure 7.39: Dialog box Edit Longitudinal Reinforcement

Clear the selection of the *Reinforcement bars statically effective* check box in the *Design* dialog section, and then exit the dialog box by clicking [OK].

The following dialog box appears:

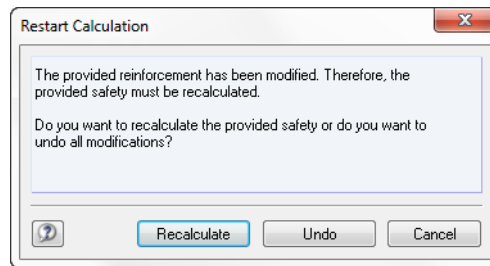


Figure 7.40: Dialog box *Restart Calculation*

To restart the calculation, click [Recalculate]. Subsequently, you can view the modified safeties in the 2.1 *Check of Members* window.

Without the secondary reinforcement, the following safety results for CO4.

	CO4
γ	1.0278

7.2 Slender Column

To recalculate the example from [2] presented according to the nonlinear method, you must first create the following model in RSTAB.

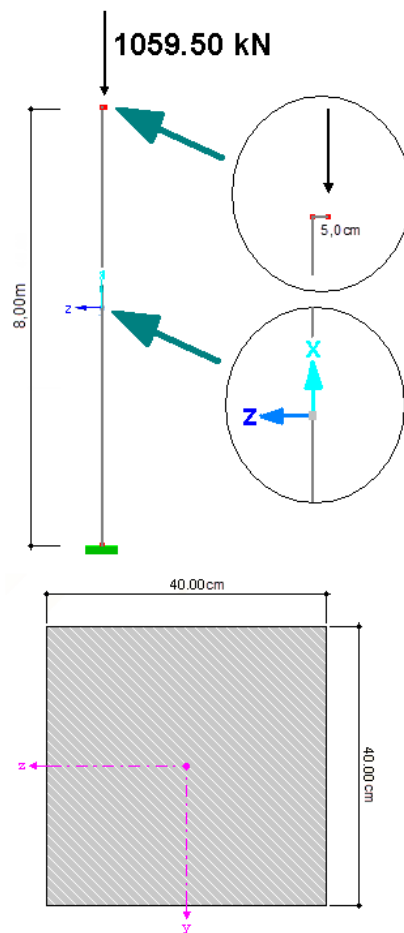


Figure 7.41: Model for the example

A restrained member is loaded with the given load of 1059.50 kN at the end of its horizontal leg (length 5 cm). Since the horizontal leg runs in the z-direction of the member coordinate system of the perpendicular member, a constant distribution of the moment about the y-axis of -52.975 kNm is obtained. The distribution of the axial force is also constant with the value of -1059.500 kN (see the following figure).

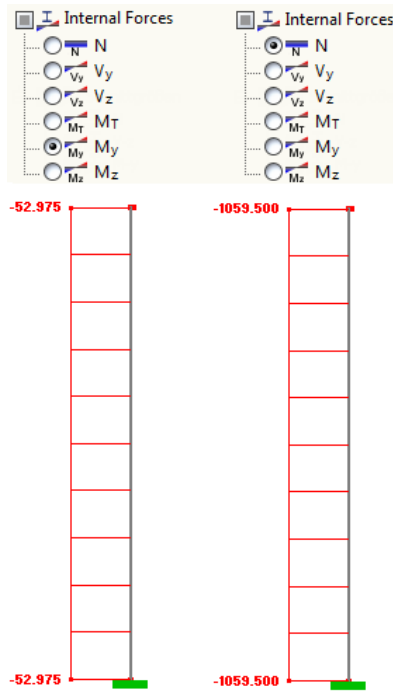


Figure 7.42: Distribution of the moment M_y and the axial force N

7.2.1 Spatial Stiffness and Stability

To obtain the same results, we exclude the stability analysis about the z-axis of the cross-section.

Details - Member No. 1			
Cross-Section		1 - Rectangle 400/400	
General Properties			
About axis y			
<input type="checkbox"/>	Buckling Possible	Buckling.y	<input checked="" type="checkbox"/>
<input type="checkbox"/>	System Unbraced	Displace.y	<input checked="" type="checkbox"/>
<input type="checkbox"/>	Column Length	l_y	8.000 m
About axis z			
<input type="checkbox"/>	Buckling Possible	Buckling.z	<input type="checkbox"/>
<input type="checkbox"/>	System Unbraced	Displace.z	<input type="checkbox"/>

Figure 7.43: Determination of directions prone to buckling

As the figure above shows, the system is defined as unbraced in the direction of the y-axis. The system length $l_{col,y}$ for this direction is determined from the length of the defined member No. 1.

7.2.2 Effective Length and Slenderness of the Column

The effective length coefficient is assumed to be $\beta = 2.0$ for a unilaterally restrained member. We enter this value under **Effective Length** → **About axis y** → **Determined Buckling Coefficient**.

Settings for Member No. 1			
Cross-Section		1 - Rectangle 400/400	
General Properties			
Effective Length			
About axis y			
<input type="checkbox"/>	Determine Buckling Length Automatically:	Detm- β	<input type="checkbox"/>
<input type="checkbox"/>	Determined Buckling Coefficient	β_z	2.000
<input type="checkbox"/>	Effective Length	$l_{0,y}$	16.000 m

Figure 7.44: Effective length

The system length $l_{col,y}$ for buckling about y-axis corresponds with the column length $l_{col} = 8.0$ m.

Thus we can determine the effective length $l_{0,y}$ for the buckling about the y-axis as follows:

$$l_{0,y} = \beta \cdot l_{col,y} = 2.0 \cdot 8.0 \text{ m} = 16.0 \text{ m}$$

The corresponding slenderness λ_y about the y-axis is then determined as:

$$\lambda_y = \frac{l_{0,y}}{i_y} = \frac{16000}{115.47} = 138.564$$

This slenderness $\lambda_y = 138.564$ is shown in the program under the following entry:

Settings for Member No. 1		
Cross-Section	1 Rectangle 400/400	
General Properties		
Effective Length		
Slenderness		
About axis y		
Slenderness	λ_y	138.564
Limiting Slenderness		

Figure 7.45: Slenderness

For the sake of completeness, we will look at all other entries before starting the calculation. The concrete imported from RSTAB is shown in the 2.1 *Materials* window. We select a corresponding reinforcement steel.

1.2 Materials				
Material No.	A	B	C	D
	Material Description			
	Concrete Strength Class	Reinforcing Steel	Remark	Comment
2	Concrete C20/25	B 500 S (B)		

Figure 7.46: Selected materials

We specify the following rebar diameters in the *Longitudinal Reinforcement* tab of the 1.4 *Reinforcement* window.

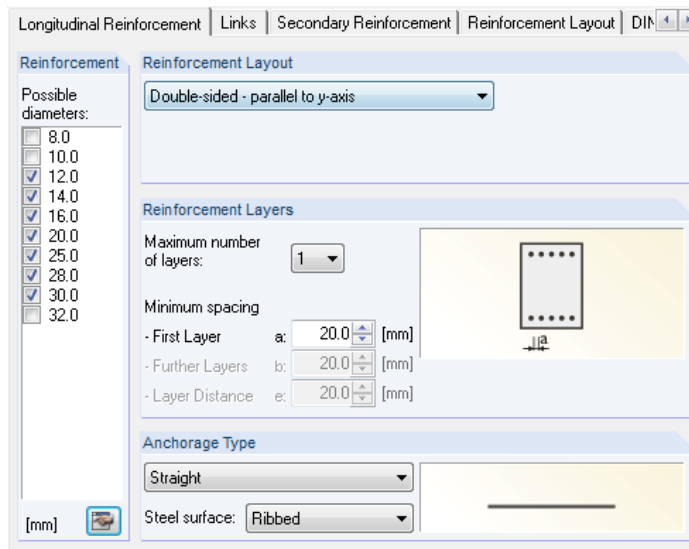


Figure 7.47: Tab *Longitudinal Reinforcement*

In the *Reinforcement Layout* tab, we define the same axial spacing of the concrete cover as in the example from literature.

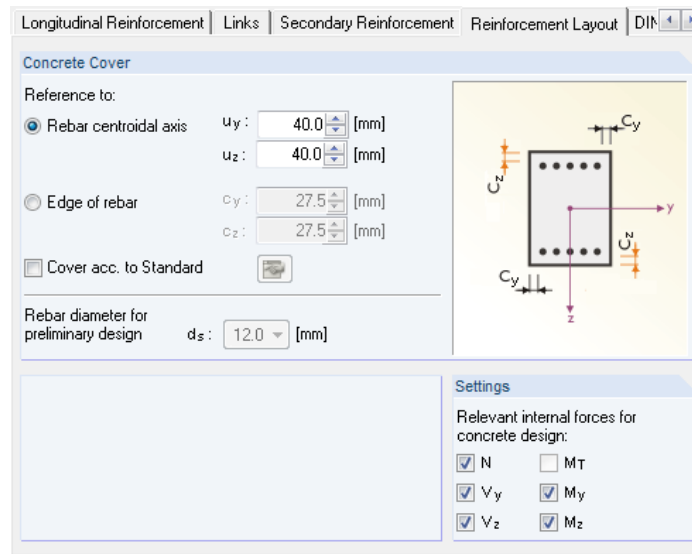


Figure 7.48: Tab *Reinforcement Layout*

Now the relevant input is complete and we can start the calculation. First, the program checks whether a standard design is sufficient or a stability analysis is necessary.

7.2.3 Limiting Slenderness According to 5.8.3.1(1)

First, the program must determine a required reinforcement for the load. This required reinforcement is given as 51.34 cm²/m in the results windows 3.1 *Required Reinforcement by Cross-Section* and 3.1 *Required Reinforcement by Member*.

3.1 Required Reinforcement by Cross-Section							
Section No.	A	B	C	D	E		Error or Notice
	Reinforcement Type	Member No.	Position x [m]	LC / CO RC	Reinforcement Area	Unit	
1	Rectangle 40/45						
	Longitudinal	1	0.000	CO1	A _s	51.34 cm ²	

Figure 7.49: Required Reinforcement

The intermediate results begin with the following three main entries:

Details - Member No. 1 - x: 0.000 m - LC1		
Governing Load		
Normal Force	N	-1059.500 kN
Moment About y-Axis	M _y	-52.975 kNm
Moment About z-Axis	M _z	0.000 kNm
Effective Length According to 5.8.3.2		
Effective Length About Axis y	l _{0,y}	16.000 m
Column Length	l _y	8.000 m
Buckling Coefficient	β _y	2.0000
Effective Length About Axis z	l _{0,z}	8.000 m
No stability check in this direction according to user specification		
Slenderness According to 5.8.3.2		
Slenderness About Axis y	λ _y	138.5640
Effective Length	l _{0,y}	16.000 m
Radius of Gyration	i _y	115.5 mm
Slenderness About Axis z	λ _z	0.0000
No stability check in this direction according to user specification		

Figure 7.50: Display of the intermediate results

To determine the limiting slenderness, the relative compression force must be determined first. The following expressions are used to this end:

$$n = \frac{N_{Ed}}{A_c \cdot f_{cd}}$$

where :

$$A_c = y \cdot z = 40 \cdot 40 = 1600 \text{ cm}^2$$

$$f_{cd} = \frac{\alpha \cdot f_{ck}}{\gamma_c} = \frac{0.85 \cdot 2,0}{1.5} = 1.133 \text{ kN/cm}^2$$

$$n = \frac{|N_{Ed}|}{A_c \cdot f_{cd}} = \frac{|1059.5|}{1600 \cdot 1.133} = 0.584 > 0.41$$

$$\lambda_{lim} = 25 \text{ for } |n| > 0.41$$

In the program, these parameters are shown under the entry *Limiting Slenderness According to 5.8.3.1(1)*.

Details - Member No.1 - x: 0.000 m - LC1			
<input checked="" type="checkbox"/> Governing Load			
<input checked="" type="checkbox"/> Effective Length According to 5.8.3.2			
<input checked="" type="checkbox"/> Slenderness According to 5.8.3.2			
<input checked="" type="checkbox"/> Limiting Slenderness According to 5.8.3.1 (1)			
<input type="checkbox"/> Relative Normal Force	n	0.5843	> 0.41
<input type="checkbox"/> Normal Force	N _{Ed}	-1059.500	kN
<input type="checkbox"/> Area of Cross-Section	A _c	1600.00	cm ²
<input type="checkbox"/> Design Value of Concrete Compr. Strength	f _{cd}	11.33	N/mm ²
<input type="checkbox"/> Char. Concrete Compressive Strength	f _{ck}	20.00	N/mm ²
<input type="checkbox"/> Reduction Factor	α	0.8500	
<input type="checkbox"/> Partial Safety Factor for Concrete	γ _c	1.5000	
<input type="checkbox"/> Limiting Slenderness About Axis y	λ _{lim,y}	25.0000	
<input type="checkbox"/> Limiting Slenderness About Axis z	λ _{lim,z}	25.0000	

Figure 7.51: Limiting slenderness according to 5.8.3.1(1)

The slenderness λ_y about the y-axis has the value of 138.564 and is greater than the limiting slenderness. Thus, according to clause 5.8.3.1(1), the second order effects must be determined.

Details - Member No.1 - x: 0.000 m - LC1			
<input checked="" type="checkbox"/> Governing Load			
<input checked="" type="checkbox"/> Effective Length According to 5.8.3.2			
<input checked="" type="checkbox"/> Slenderness According to 5.8.3.2			
<input checked="" type="checkbox"/> Limiting Slenderness According to 5.8.3.1 (1)			
<input checked="" type="checkbox"/> Design Type			
<input type="checkbox"/> Conditions of standard design according to 5.8.3.1 (1)			
<input type="checkbox"/> Condition About Axis y	λ _y ≤ λ _{lim,y}	Failed	
<input type="checkbox"/> Slenderness Provided	λ _y	138.5640	
<input type="checkbox"/> Limiting Slenderness About Axis y	λ _{lim,y}	25.0000	
<input type="checkbox"/> Condition About Axis z	λ _z ≤ λ _{lim,z}	Passed	
<input type="checkbox"/> No stability check in this direction according to user specification			
<input type="checkbox"/> Condition of standard design fulfilled?		Failed	
<input type="checkbox"/> Conditions of standard design according to 5.8.3.1 (1)			
<input type="checkbox"/> System immobile?		No	
<input type="checkbox"/> No load moment(s) at the end of the column?		No	
<input type="checkbox"/> Column not loaded by shear load?		Yes	
<input type="checkbox"/> Normal force distribution constant?		Yes	
<input type="checkbox"/> Normal force is not a compressive force?		No	
<input type="checkbox"/> Condition of standard design fulfilled?		No	
<input type="checkbox"/> Stability Check Required			

Figure 7.52: Design Type

7.2.4 Intended Eccentricity According to 5.8.8.2

The intended eccentricity according to EN 1992-1-1 is determined as:

$$e_0 = \frac{M}{N} = \frac{-52.97 \text{ kNm}}{-1059.50 \text{ kN}} = 0.05 \text{ m}$$

Details - Member No.1 - x: 0.000 m - LC1			
<input checked="" type="checkbox"/> Governing Load			
<input checked="" type="checkbox"/> Effective Length According to 5.8.3.2			
<input checked="" type="checkbox"/> Slenderness According to 5.8.3.2			
<input checked="" type="checkbox"/> Limiting Slenderness According to 5.8.3.1 (1)			
<input checked="" type="checkbox"/> Design Type			
<input checked="" type="checkbox"/> Eccentricities			
<input checked="" type="checkbox"/> Intended Eccentricity According to 5.8.8.2			
<input type="checkbox"/> Intended Eccentricity in z-direction	$e_{0,z}$	-50.0	mm
<input type="checkbox"/> Moment Diagram Along the Support	Diagram M_y	Constant	
<input type="checkbox"/> Moment About Axis y	M_y	-52.975	kNm
<input type="checkbox"/> Absolute Normal Force	N	1059.500	kN
<input checked="" type="checkbox"/> Intended Eccentricity in y-direction	$e_{0,y}$	0.0	mm
<input type="checkbox"/> Moment Diagram Along the Support	Diagram M_z	Constant	
<input type="checkbox"/> Moment About Axis z	M_z	0.000	kNm
<input type="checkbox"/> Absolute Normal Force	N	1059.500	kN

Figure 7.53: Intended eccentricity according to 5.8.8.2

7.2.5 Eccentricity due to Imperfections According to 5.2

Imperfections may be calculated as inclination according to 5.2(5).

$$\theta_i = \theta_0 \cdot \alpha_n \cdot \alpha_m = 1/200 \cdot 2/\sqrt{8} \cdot \sqrt{(0.5 \cdot (1+1/1))} = 0.003536$$

$$e_i = l \cdot \theta_i = 8000 \cdot 0.003536 = 28.3 \text{ mm}$$

Details - Member No.1 - x: 0.000 m - LC1			
<input checked="" type="checkbox"/> Governing Load			
<input checked="" type="checkbox"/> Effective Length According to 5.8.3.2			
<input checked="" type="checkbox"/> Slenderness According to 5.8.3.2			
<input checked="" type="checkbox"/> Limiting Slenderness According to 5.8.3.1 (1)			
<input checked="" type="checkbox"/> Design Type			
<input checked="" type="checkbox"/> Eccentricities			
<input checked="" type="checkbox"/> Intended Eccentricity According to 5.8.8.2			
<input checked="" type="checkbox"/> Eccentricity due to imperfection according to 5.2			
<input checked="" type="checkbox"/> Eccentricity Due to Imperfection in z-direc	$e_{i,z}$	-28.3	mm
<input type="checkbox"/> Inclination	$\theta_{i,z}$	0.0035	
<input type="checkbox"/> Basic Value of Inclination	θ_0	0.0035	
<input type="checkbox"/> Column Length	l_y	8.000	m
<input checked="" type="checkbox"/> Reduction Factor for Column Number	α_m	1.0000	
According to user specification, the column will be designed as a single column			
<input type="checkbox"/> Buckling Length	$l_{0,y}$	16.000	m
<input checked="" type="checkbox"/> Eccentricity Due to Imperfection in y-direc	$e_{i,y}$	0.0	mm
No eccentricity due to imperfections, as there is no buckling risk according to user :			

Figure 7.54: Eccentricity due to imperfections according to 5.2

7.2.6 Minimum Eccentricity According to 6.1.(4)

As a rule, a minimum eccentricity of $e_{\min} = h / 30 \geq 20 \text{ mm}$ (where h is the cross-section height) is to be applied for cross-sections with normal compressive force:

$$e_{\min} = 400 / 30 = 13.33 \text{ mm} \Rightarrow 20 \text{ mm}$$

Details - Member No.1 - x: 0.000 m - LC1			
<input checked="" type="checkbox"/> Governing Load			
<input checked="" type="checkbox"/> Effective Length According to 5.8.3.2			
<input checked="" type="checkbox"/> Slenderness According to 5.8.3.2			
<input checked="" type="checkbox"/> Limiting Slenderness According to 5.8.3.1 (1)			
<input checked="" type="checkbox"/> Design Type			
<input checked="" type="checkbox"/> Eccentricities			
<input checked="" type="checkbox"/> Intended Eccentricity According to 5.8.8.2			
<input checked="" type="checkbox"/> Eccentricity due to imperfection according to 5.2			
<input checked="" type="checkbox"/> Minimum Eccentricity According to 6.1 (4)			
<input type="checkbox"/>	Minimum Eccentricity in z-direction	$e_{\min,z}$	-20.0 mm
<input type="checkbox"/>	Thickness of Structural Member	$h_{w,z}$	400.0 mm
<input type="checkbox"/>	Minimum Value of Minimum Eccentricity	$e_{20 \text{ mm},z}$	20.0 mm
<input type="checkbox"/>	Minimum Eccentricity in y-direction	$e_{\min,y}$	0.0 mm
<input type="checkbox"/> No use of minimum eccentricity, as there is no buckling risk according to the user sp			

Figure 7.55: Minimum eccentricity according to 6.1.(4)

7.2.7 Moments According to First Order Theory

The first order moments are determined as follows.

$$M_{Ed,1} = N_{Ed} \cdot (e_{0,z} + e_{i,z}) = -1059.50 \cdot (0.05 + 0.0283) = -82.94 \text{ kNm}$$

Details - Member No.1 - x: 0.000 m - LC1			
<input checked="" type="checkbox"/> Governing Load			
<input checked="" type="checkbox"/> Effective Length According to 5.8.3.2			
<input checked="" type="checkbox"/> Slenderness According to 5.8.3.2			
<input checked="" type="checkbox"/> Limiting Slenderness According to 5.8.3.1 (1)			
<input checked="" type="checkbox"/> Design Type			
<input checked="" type="checkbox"/> Eccentricities			
<input checked="" type="checkbox"/> Moments According to First Order Theory			
<input type="checkbox"/> Moments According to First Order Theory			
<input type="checkbox"/>	Design Normal Force	N_{Ed}	-1059.500 kN
<input type="checkbox"/>	Moment About Axis y	$M_{Ed,1,y}$	-82.942 kNm
<input type="checkbox"/>	Calculated Total Eccentricity in z-Direc	$e_{\text{calc } 1,z}$	-78.3 mm
<input type="checkbox"/>	Intended Eccentricity	$e_{0,z}$	-50.0 mm
<input type="checkbox"/>	Eccentricity Due to Imperfection	$e_{i,z}$	-28.3 mm
<input type="checkbox"/>	Moment About Axis z	$M_{Ed,1,z}$	0.000 kNm
<input type="checkbox"/> No buckling risk according to user specifications			

Figure 7.56: Moments according to first order theory

7.2.8 Second Order Moments

The second order moment M_2 according to 5.8.8.2(3) is given as:

$$M_2 = N_{Ed} \cdot e_2$$

where :

- N_{Ed} Design value of the axial force
- e_2 Deformation (= additional eccentricity due to loading)
 $e_2 = (1/r) \cdot (l_0)^2 / c$
- $1/r$ Curvature
- l_0 Buckling length
- c Factor depending on the curvature distribution = π^2

The curvature according to 5.8.8.3(1) for structural components with a constant symmetrical cross-section (including reinforcement) may be calculated as follows:

$$1/r = K_r \cdot K_\phi \cdot 1/r_0$$

$K_r = (n_u - n) / (n_u - n_{bal})$ Correction factor depending on axial force according to 5.8.8.3(3)

$$n = N_{Ed} / (A_e \cdot f_{cd}) = 1059.500 / (1600 \cdot 11.33) \cdot 100 = 0.5843 \quad \text{Relative axial force}$$

$$\omega = A_s \cdot f_{yd} / (A_c \cdot f_{cd}) = 63.71 \cdot 434.78 / (1600 \cdot 11.33) = 1.5280$$

$$n_u = 1 + \omega = 1 + 1.5280 = 2.5280$$

$$n_{bal} = 0.4$$

$$K_r = (n_u - n) / (n_u - n_{bal}) = (2.5280 - 0.5843) / (2.5280 - 0.4) = 0.9134 \leq 1.00$$

$K_\phi = 1 + \beta \cdot \phi_{ef}$ Factor for taking account of creep according to 5.8.8.3(4)

$$\beta = 0.35 + f_{ck} / 200 - \lambda / 150 = 0.35 + 20 / 200 - 138.564 / 150 = -0.474$$

$\phi_{ef} = \phi(\infty, t_0) \cdot M_{0Eqp} / M_{0Ed}$ Effective creep ratio according to 5.8.4

$\phi(\infty, t_0)$ Final creep ratio acc. to 3.1.4 acc. to specifications in window 1.3 *Cross-Sections*

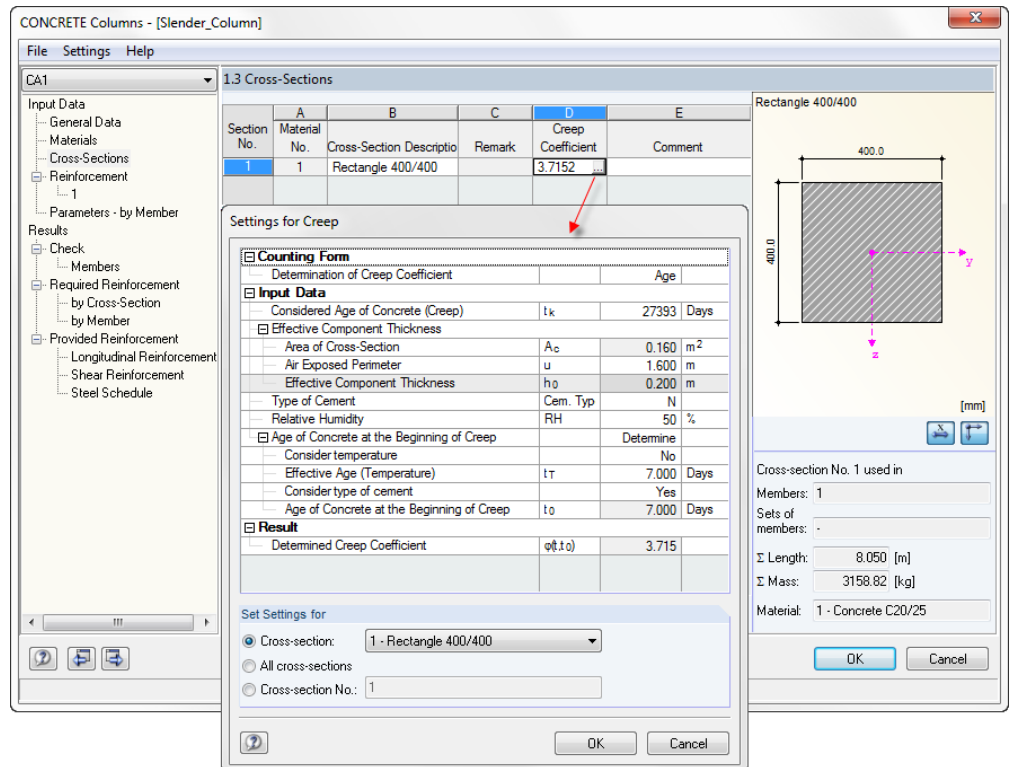


Figure 7.57: Determination of the creep ratio in window 1.3

$$\phi_{ef} = \phi(\infty, t_0) \cdot M_{0Eqp} / M_{0Ed} = 3.7152 \cdot 82.942 / 82.942 = 3.7152$$

M_{0Eqp} is the second order bending moment under the quasi-permanent load combination. M_{0Ed} is the first order bending moment under the design load combination. The ratio can be limited to 1.00 in the *Creep-Producing Permanent Load* tab of the 1.1 *General Data* window.

$$K_\phi = 1 + \beta \cdot \phi_{ef} = 1 + (-0.474) \cdot 3.7152 = -0.449 \geq 1.0$$

$$1/r_0 = \epsilon_{yd} / (0.45 \cdot d) = 2.17 / (0.45 \cdot 360) = 0.013 \text{ 1/m}$$

$$1/r = K_r \cdot K_\phi \cdot 1/r_0 = 0.9134 \cdot 1.0 \cdot 0.013 = 0.012$$

The additional eccentricity of load e_2 due to second order effects is given by the following expression.

$$e_2 = (1/r) \cdot (l_0)^2 / c = 0.012 \cdot 16^2 / \pi^2 = 0.3138\text{m}$$

If the eccentricities due to second order theory are known, the second order moments can be determined as:

$$M_2 = N_{Ed} \cdot e_2 = 1059.5 \cdot 0.3138 = 332.47 \text{ kNm}$$

$$M_{Ed,2} = N_{Ed} \cdot (e_0 + e_1 + e_2) = 1059.5 \cdot (0.050 + 0.0283 + 0.3138) = 415.389 \text{ kNm}$$

Details - Member No.1 - x: 0.000 m - LC1			
<input checked="" type="checkbox"/> Governing Load			
<input checked="" type="checkbox"/> Effective Length According to 5.8.3.2			
<input checked="" type="checkbox"/> Slenderness According to 5.8.3.2			
<input checked="" type="checkbox"/> Limiting Slenderness According to 5.8.3.1 (1)			
<input checked="" type="checkbox"/> Design Type			
<input checked="" type="checkbox"/> Eccentricities			
<input checked="" type="checkbox"/> Moments According to First Order Theory			
<input checked="" type="checkbox"/> Moments According to Second Order Theory			
<input checked="" type="checkbox"/> Eccentricity Through Second Ord. Th. According to 5.8.8.2(3)			
<input checked="" type="checkbox"/> Eccentricity Through Second Order Thec	$e_{2,z}$	-313.8	mm
<input checked="" type="checkbox"/> Curvature in z-plane	$1/r_z$	1.0000	
<input checked="" type="checkbox"/> Selected Factor (Normal Force)	sel $K_{r,z}$	138.5640	
<input checked="" type="checkbox"/> Calculated Factor (Normal Force)	$K_{r,z}$	0.012	1/m
<input checked="" type="checkbox"/> Max. Ultimate Limit State	n_u	0.9125	
<input checked="" type="checkbox"/> Ratio	ω	0.9125	
<input checked="" type="checkbox"/> Relative Normal Force	n	2.5065	
<input checked="" type="checkbox"/> Resistant Concrete Normal Fon	n_{bal}	1.5065	
<input checked="" type="checkbox"/> Selected Factor (Creep)	sel $K_{\phi,z}$	-0.5843	
<input checked="" type="checkbox"/> Calculated Factor (Creep)	$K_{\phi,z}$	-0.4000	
<input checked="" type="checkbox"/> Curvature in z-plane	$1/r_{0,z}$	0.012	1/m
<input checked="" type="checkbox"/> Strain (Yield Stress)	ϵ_{yd}	2.17	‰
<input checked="" type="checkbox"/> Design Value of Yield Stress	f_{yd}	434.78	N/mm ²
<input checked="" type="checkbox"/> E-modulus	E_s	200000.00	N/mm ²
<input checked="" type="checkbox"/> Effective Depth	d_z	360.0	mm
<input checked="" type="checkbox"/> Buckling Length	$l_{0,z}$	16.000	m
<input checked="" type="checkbox"/> Factor (Curvature Distribution)	c	9.8696	
<input checked="" type="checkbox"/> Eccentricity Through Second Order Thec	$e_{2,y}$	0.0	mm
<input checked="" type="checkbox"/> Curvature in y-plane	$1/r_y$	0.014	1/m
<input checked="" type="checkbox"/> Buckling Length	$l_{0,z}$	12.400	m
<input checked="" type="checkbox"/> Factor (Curvature Distribution)	c	9.8696	
No stability check in this direction according to user specification			
<input checked="" type="checkbox"/> Moments According to Second Order Theory			
<input checked="" type="checkbox"/> Design Normal Force	N_{Ed}	-1059.500	kN
<input checked="" type="checkbox"/> Moment About Axis y	$M_{Ed,y2}$	-415.389	kNm
<input checked="" type="checkbox"/> Total Eccentricity in z-direction	$e_{2,tot,z}$	-392.1	mm
<input checked="" type="checkbox"/> Eccentricity Through Second Ord. T	$e_{2,z}$	-313.8	mm
<input checked="" type="checkbox"/> Eccentricity (First Ord. Th.) in z-direc	$e_{1,z}$	-78.3	mm
<input checked="" type="checkbox"/> Intended Eccentricity	$e_{0,z}$	-50.0	mm
<input checked="" type="checkbox"/> Eccentricity Due to Imperfection	$e_{i,z}$	-28.3	mm
<input checked="" type="checkbox"/> Minimum Eccentricity in z-direction	$e_{min,z}$	-20.0	mm
<input checked="" type="checkbox"/> Moment About Axis z	$M_{Ed,z2}$	0.000	kNm

Figure 7.58: Moments according to second order theory

The first design is carried out for this applied second order moment together with the applied axial force. In the subsequent program flow, the required reinforcement is taken as provided reinforcement for every repeated design. Next, the applied second order moment is redetermined. A required reinforcement is recalculated for these moments. The recalculated reinforcement is reapplied as provided reinforcement to determine a new second order moment. This interaction between provided reinforcement and second order moments is continued until the moment does no longer change significantly.

In our case, the moment is changed from 415.389 kNm to 412.565 kNm. Together with the axial force 1059.50 kN, this value is used for the design.

Intermediate Results Rectangle 400/400 - LC1			
☑ Governing Load			
☑ Effective Length According to 5.8.3.2			
☑ Slenderness According to 5.8.3.2			
☑ Limiting Slenderness According to 5.8.3.1 (1)			
☑ Design Type			
☑ Eccentricities			
☑ Moments According to First Order Theory			
☑ Moments According to Second Order Theory			
☑ Statically Required Reinforcement			
☑ Design Internal Forces			
Normal Force	N_{Ed}	-1059.50	kN
Moment About y-Axis Due to Second Ord	$M_{Ed,y2}$	-412.565	kNm
Moment About z-Axis Due to Second Ord	$M_{Ed,z2}$	0.000	kNm
☑ Curvatures			
Curvature in Plane z	$1/r_z$	-0.015	1/m
Curvature in Plane y	$1/r_y$	0.000	1/m
☑ Points of Cross-Section			
☑ Rebars			
Statically Required Reinforcement	req $A_{s,stat}$	51.34	cm ²

Figure 7.59: Statically required reinforcement

Under the entry *Point of Cross-Section*, the concrete strains and stresses can be found for every point shown in the graphic on the right-hand side.

☑ Cross-Section Point			
No.		1	
Coordinate y	y_c	200.0	mm
Coordinate z	z_c	200.0	mm
Strain	ϵ_c	-3.50	‰
Stress	σ_c	-11.33	N/mm ²
☑ Cross-Section Point			
No.		2	
☑ Cross-Section Point			
No.		3	
☑ Cross-Section Point			
No.		4	

Figure 7.60: Stresses and strains of the individual cross-section points

Similarly, the coordinates of the individual rebars as well as the strains and stresses in these bars are shown under the entry *Rebars*.

☑ Rebars			
Number of Reinforcement Bars	n_s	22	
☑ Reinforcement Bar			
No.		1	
Coordinate y	y_s	-16.0	mm
Coordinate z	z_s	16.0	mm
Strain	ϵ_s	-2.91	‰
Stress	σ_s	-434.78	N/mm ²
☑ Reinforcement Bar			
No.		2	

Figure 7.61: Stresses and strains of the individual rebars

Strains and stresses are shown together in the graphic window for concrete and reinforcement. This representation can be changed by using the various buttons below the graphic window. Moreover, you can open a special dialog box, showing the stresses and strains in a clearly-arranged way in two tables for concrete and steel.

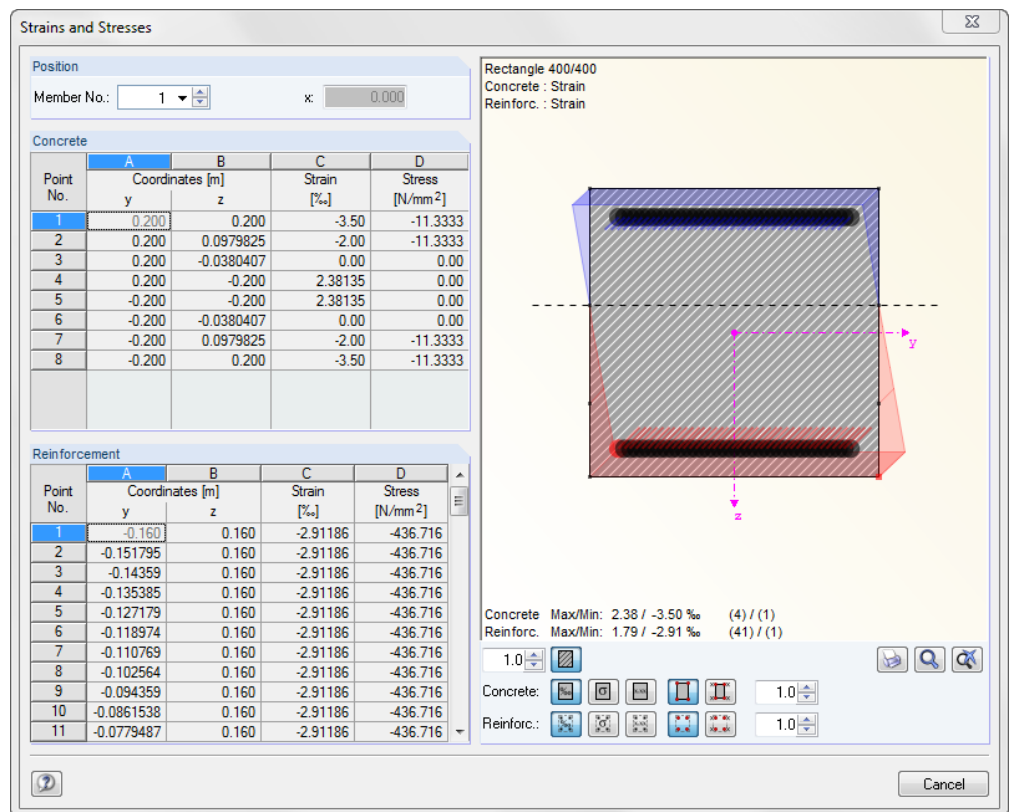


Figure 7.62: Representation of the strains and stresses of concrete and reinforcement

The details table in the window 3.1 *Required Reinforcement by Cross-Section* is concluded by two entries: the entry concerning the determination of the *Minimum Reinforcement* and the entry regarding the *Required Reinforcement* that is obtained as the greater reinforcement from the statically required reinforcement and the minimum reinforcement.

Intermediate Results Rectangle 400/400 - LC1			
Governing Load			
Effective Length According to 5.8.3.2			
Slenderness According to 5.8.3.2			
Limiting Slenderness According to 5.8.3.1 (1)			
Design Type			
Eccentricities			
Moments According to First Order Theory			
Moments According to Second Order Theory			
Statically Required Reinforcement			
Min. Reinforcement According to Standard			
Design Normal Force	N _{Ed}	-1059.500	kN
Design Value of Yield Stress	f _{yd}	434.78	N/mm ²
Minimum Reinforcement Acc. to Standard	req A _{s,min,Stand}	3.66	cm ²
Required Reinforcement			
Statically Required Reinforcement	req A _{s,stat}	51.34	cm ²
Minimum Reinforcement Acc. to Standard	req A _{s,min,Stand}	3.66	cm ²
Required Reinforcement	req A _s	51.34	cm ²

Figure 7.63: Entries *Minimum Reinforcement* and *Required Reinforcement*

The minimum reinforcement is determined according to EN 1992-1-1, 9.5.2(2) as follows:

$$A_{s,min} = 0.15 \cdot \frac{|N_{Ed}|}{f_{yd}} = 0.15 \cdot \frac{|-1059,50|}{43.478} = 3.66 \text{ cm}^2$$

7.2.9 Provided Reinforcement

According to EN 1992-1-1 clause 9.5.2(3), the total reinforcement area may not exceed the maximum value of $0.09 A_c$.

$$A_{s,max} = 0.09 \cdot A_c = 0.09 \cdot 1600 \text{ cm}^2 = 162 \text{ cm}^2$$

We provided the following rebar diameters to the program: 12, 14, 16, 20, 25, and 28 mm.

The program searches for the rebars yielding the most economical solution, that is, the provided reinforcement area shall be as close as possible but greater than the required reinforcement area.

A provided safety of ultimate state of 1.1094 is calculated.

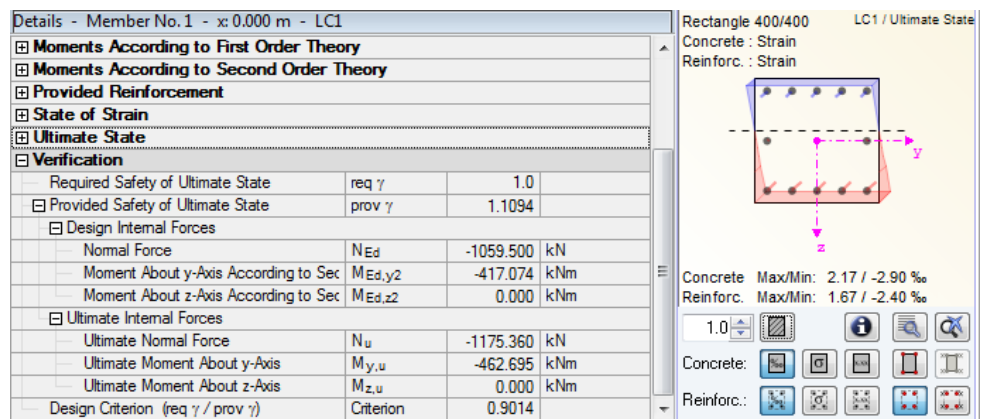


Figure 7.64: Provided safety of ultimate state

Parallel to the y-axis of the cross-section, five rebars with a diameter of 22 mm are arranged for each side.

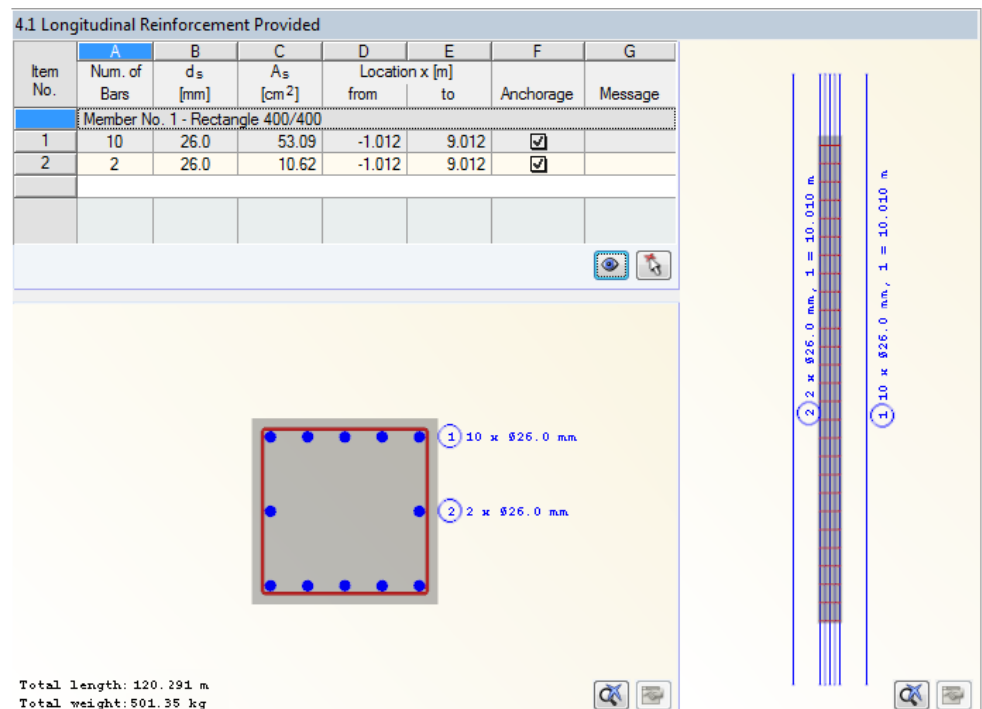


Figure 7.65: Longitudinal Reinforcement Provided

The secondary reinforcement can be defined as statically ineffective in the dialog box *Edit Longitudinal Reinforcement*.

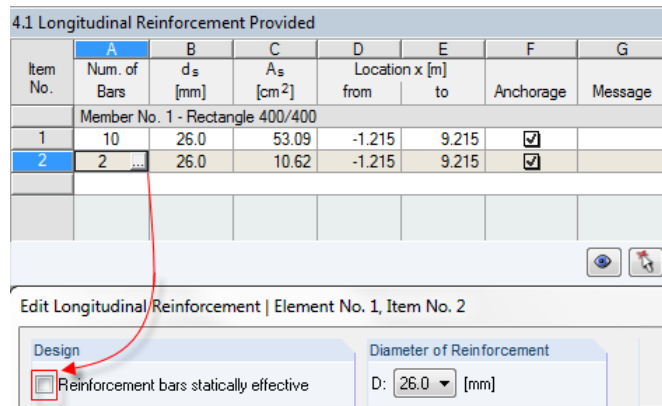


Figure 7.66: Deactivating the static effectiveness of the secondary reinforcement

The calculation is restarted, thus reperforming the safety analysis. Without considering the secondary reinforcement, the provided safety is reduced from 1.1094 to 1.0247.

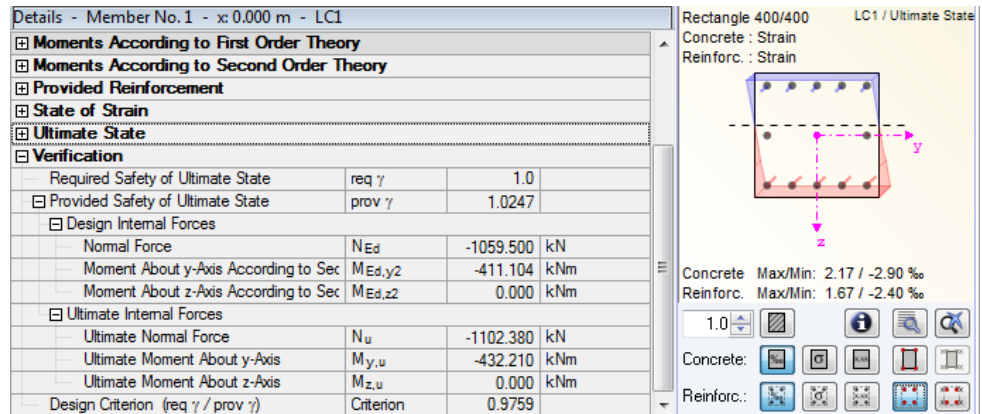


Figure 7.67: Provided safety of ultimate state without secondary reinforcement

The influence of the provided longitudinal reinforcement on the safety can be seen under different entries of the details. First, a modified provided longitudinal reinforcement has an impact on the applied second order moment.

The statically effective reinforcement can be found in the following entries of the details tables:

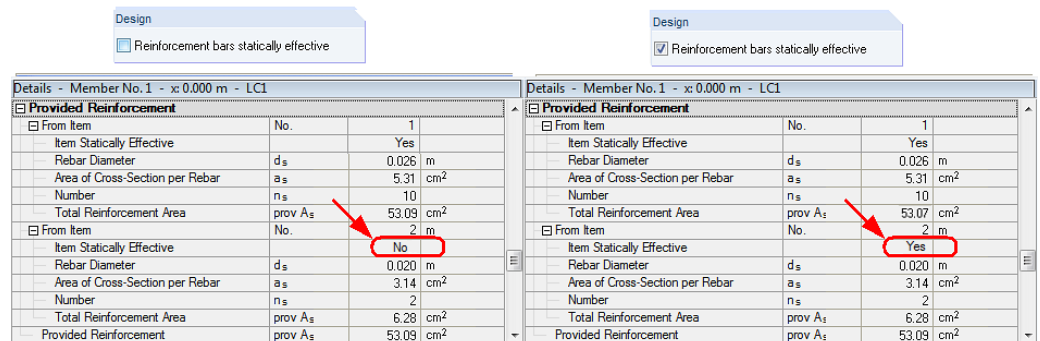


Figure 7.68: Check of the static effectiveness of an item

Furthermore, only the statically effective rebars are shown in the display of the stresses and deformations in the table and graphic.

7.3 Fire Resistance Design

The following specifications were entered for the fire resistance design according to example 10 [3]. We analyze the column with four sides exposed to fire according to the fire resistance class R30.

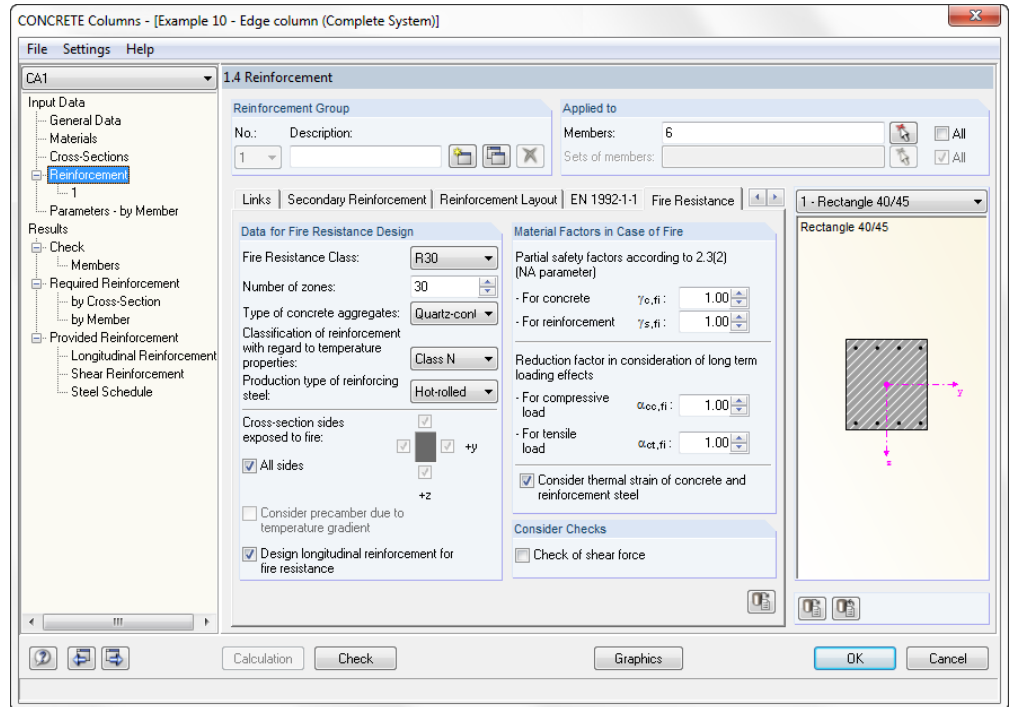


Figure 7.69: Window 1.4 Reinforcement, tab Fire Resistance

To start the calculation, we click the [Calculation] button. The 2.1 Check of Members window shows the results.

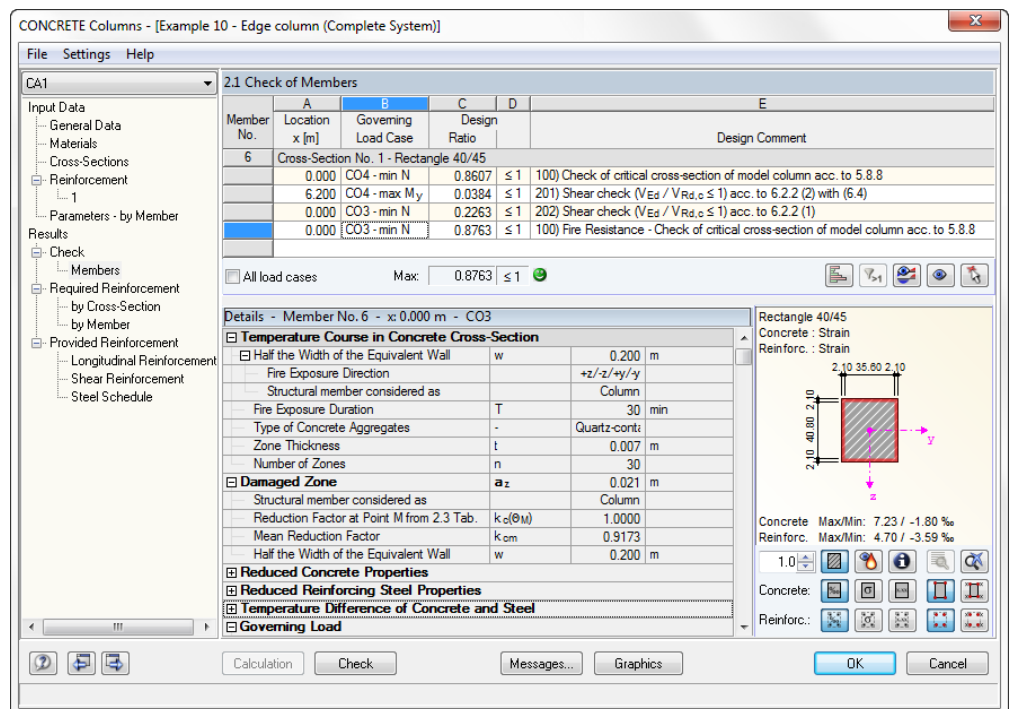


Figure 7.70: Window 2.1 Check of Members

This table shows for each designed cross-section the governing safety values determined during the fire resistance design. The values result from the entered parameters of the reinforcement groups for the fire designs, the provided reinforcement, and the internal forces of the relevant actions.

In the lower part of the window, the *Details* for the entry selected in the table row above are shown. Thus, due to the intermediate results, it is possible to evaluate the results specifically. The output of the design details in the lower part will be updated automatically as soon as another row is selected in the upper part.

Member No.

For each cross-section and each design type, the table shows the number of the member providing the smallest safety.

Location x

The column shows the respective x-location on the member which is governing for the fire resistance design. For the table output, the program uses the following RSTAB member locations x :

- Start and end node
- Partition points according to possibly defined member division
- Extreme values of internal forces

Governing Load Case

This column displays the numbers of the load cases, load combinations, or result combinations that are decisive for the respective designs.

Design, Ratio

This column informs about the minimum safety factors γ for each type of design. If the safety is less than 1, the fire resistance design is fulfilled.

The design relevant input data and the intermediate values are specified in the *Details* table.

Details - Member No. 6 - x: 0.000 m - CO3			
<input checked="" type="checkbox"/> Temperature Course in Concrete Cross-Section			
<input type="checkbox"/> Half the Width of the Equivalent Wall	w	0.200	m
Fire Exposure Direction		+z/-z/+y/-y	
<input type="checkbox"/> Structural member considered as		Column	
Fire Exposure Duration	T	30	min
Type of Concrete Aggregates	-	Quartz-cont:	
Zone Thickness	t	0.007	m
Number of Zones	n	30	
<input checked="" type="checkbox"/> Damaged Zone	a _z	0.021	m
<input type="checkbox"/> Structural member considered as		Column	
Reduction Factor at Point M from 2.3 Tab.	k _c (θ_M)	1.0000	
Mean Reduction Factor	k _{cm}	0.9173	
<input type="checkbox"/> Half the Width of the Equivalent Wall	w	0.200	m
<input checked="" type="checkbox"/> Reduced Concrete Properties			
<input checked="" type="checkbox"/> Reduced Reinforcing Steel Properties			
<input checked="" type="checkbox"/> Temperature Difference of Concrete and Steel			

Figure 7.71: Information on the *Temperature Course* and the *Damaged Zone*

In the graphic, the temperature course and the damaged zone can be shown together with the dimensions. The detailed values for the individual zones can be displayed by clicking the corresponding buttons (see the following figure).

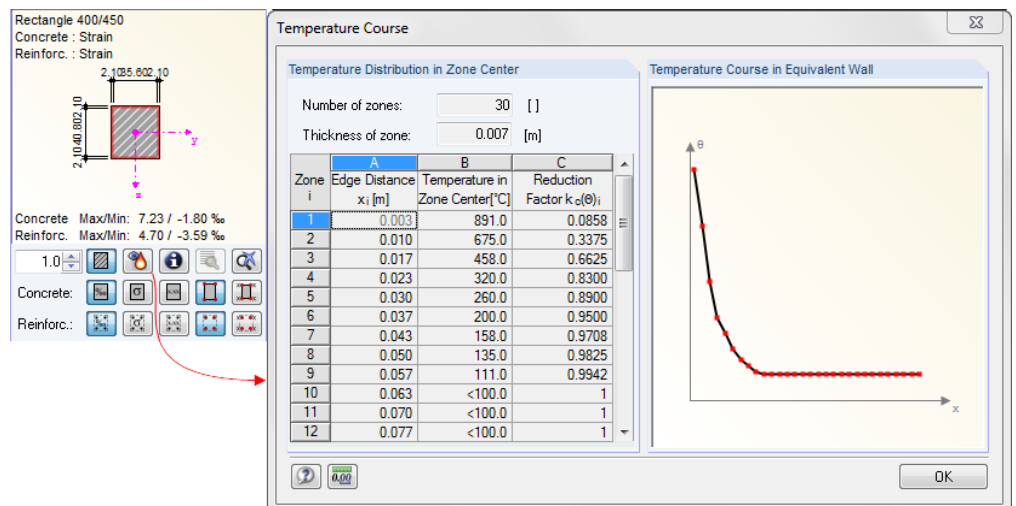


Figure 7.72: Temperature course and damaged zone - graphic

A table displays the *Temperature Distribution in Zone Center*. The graphic shows the *Temperature Course in Equivalent Wall* according to EN 1992-1-2, Annex A.

The reduced properties for concrete and steel are used in the calculation.

Details - Member No. 6 - x: 0.000 m - CO3			
Temperature Course in Concrete Cross-Section			
Damaged Zone	a_z	0.021 m	
Reduced Concrete Properties			
<input type="checkbox"/> Reduced Concrete Compressive Strength	$f_{ck}(\theta)$	30.000	N/mm ²
<input type="checkbox"/> Temperature at Point M from 2.3 Tab.	θ_M	100	°C
<input type="checkbox"/> Reduction Factor for Concrete Compressi	$k_{c,i}(\theta_M)$	1.0000	
<input type="checkbox"/> Reduced Tensile Strength	$f_{ct}(\theta)$	2.900	N/mm ²
<input type="checkbox"/> Reduction Factor for Concrete Compressi	$k_{c,i}(\theta_M)$	1.0000	
<input type="checkbox"/> Reduction Factor for Concrete Tensile St	$k_{c,i}(\theta_M)$	1000.0000	
<input type="checkbox"/> Reduced Modulus of Elasticity	$E_{cd}(\theta)$	28300.000	N/mm ²
<input type="checkbox"/> Temperature at Point M from 2.3 Tab.	θ_M	100	°C
<input type="checkbox"/> Reduction Factor for Concrete Compressi	$k_{c,i}(\theta_M)$	1.0000	
Reduced Reinforcing Steel Properties			
Temperature Difference of Concrete and Steel			

Figure 7.73: Reduced concrete properties

Details - Member No. 6 - x: 0.000 m - CO3			
Reduced Concrete Properties			
Reduced Reinforcing Steel Properties			
<input type="checkbox"/> Reduced Tensile Strength of Reinforcemen	$f_{sy,t}(\theta)$	401.000	N/mm ²
<input type="checkbox"/> Temperature at the Center of the Reinfor	θ_s	298	°C
<input type="checkbox"/> Reinforcing Bar Strain at Temperature θ	$\epsilon_{s,fi}$	0.250	%
<input type="checkbox"/> Reduction Factor for Tensile Strength	$k_{s,t}(\theta)$	0.8020	
<input type="checkbox"/> Applied Curve from Fig. 4.2		3.0000	
<input type="checkbox"/> Reduced Modulus of Elasticity for Tensile S	$E_{sy,t}(\theta)$	160400.000	N/mm ²
<input type="checkbox"/> Temperature at the Center of the Reinfor	θ_s	298	°C
<input type="checkbox"/> Reinforcing Bar Strain at Temperature θ	$\epsilon_{s,fi}$	0.250	%
<input type="checkbox"/> Reduction Factor for Modulus of Elasticity	$E_{sy,t}(\theta) / E_s$	0.8020	
<input type="checkbox"/> Reduced Compressive Strength of Reinforc	$f_{sy,c}(\theta)$	401.000	N/mm ²
<input type="checkbox"/> Temperature at the Center of the Reinfor	θ_s	298	°C
<input type="checkbox"/> Reduction Factor for Compressive Streng	$k_{s,c}(\theta)$	0.8020	
<input type="checkbox"/> Applied Curve from Fig. 4.2		3.0000	
<input type="checkbox"/> Reduced Modulus of Elasticity for Compress	$E_{sy,c}(\theta)$	160400.000	N/mm ²
<input type="checkbox"/> Temperature at the Center of the Reinfor	θ_s	298	°C
<input type="checkbox"/> Reduction Factor for Modulus of Elasticity	$E_{sy,c}(\theta) / E_s$	0.8020	
<input type="checkbox"/> Reduced Steel Tensile Strength of Shear R	$f_{sy,sw,t}(\theta)$	412.000	N/mm ²
<input type="checkbox"/> Reference Temperature	$\theta_{P,sw}$	480	°C
<input type="checkbox"/> Reduction Factor for Tensile Strength	$k_{s,sw}(\theta)$	0.8240	
<input type="checkbox"/> Applied Curve from Fig. 4.2		3.0000	

Figure 7.74: Reduced reinforced steel properties

Details - Member No.6 - x: 0.000 m - CO3			
<input type="checkbox"/> Temperature Course in Concrete Cross-Section			
<input type="checkbox"/> Damaged Zone	a _z	0.021	m
<input type="checkbox"/> Reduced Concrete Properties			
<input type="checkbox"/> Reduced Reinforcing Steel Properties			
<input type="checkbox"/> Temperature Difference of Concrete and Steel			
<input type="checkbox"/> Length change of concrete	ε _{c,fi}	0.153	%
<input type="checkbox"/> Mean value of concrete temperature	θ _c	176	°C
<input type="checkbox"/> Type of Concrete Aggregates	-	Quartz-cont:	
<input type="checkbox"/> Length change of steel	ε _{s,fi}	0.369	%
<input type="checkbox"/> Temperature at the Center of the Reinforcin	θ _s	298	°C
<input type="checkbox"/> Governing Load			

Figure 7.75: Temperature gradient of concrete and steel

At the end of the *Details* table, all initial values of the designs are shown. The design safeties result from the ratio of the ultimate internal force in case of fire and the analyzed internal force acting on the cross-section.

Details - Member No.6 - x: 0.000 m - CO3			
<input type="checkbox"/> Verification			
<input type="checkbox"/> Required Safety of Ultimate State	req γ	1.0	
<input type="checkbox"/> Provided Safety of Ultimate State	prov γ	1.1411	
<input type="checkbox"/> Design Internal Forces			
<input type="checkbox"/> Normal Force	N _{Ed}	-431.000	kN
<input type="checkbox"/> Moment About y-Axis According to Sec	M _{Ed,y2}	-202.890	kNm
<input type="checkbox"/> Moment About z-Axis According to Sec	M _{Ed,z2}	8.620	kNm
<input type="checkbox"/> Ultimate Internal Forces			
<input type="checkbox"/> Ultimate Normal Force	N _u	-491.828	kN
<input type="checkbox"/> Ultimate Moment About y-Axis	M _{y,u}	-231.522	kNm
<input type="checkbox"/> Ultimate Moment About z-Axis	M _{z,u}	9.836	kNm
<input type="checkbox"/> Design Criterion (req γ / prov γ)	Criterion	0.8763	

Figure 7.76: Verification

The *Design Criterion* shows that the design is fulfilled.

8. ACI 318-11

This chapter describes the design of concrete columns according to ACI 318-11 (USA). The description is divided in two parts: The first part *Calculation According to ACI 318* gives theoretical information on the design process. In the second part *Data Input for ACI* the preparation and input of the data is described that are relevant for the U.S. standard.

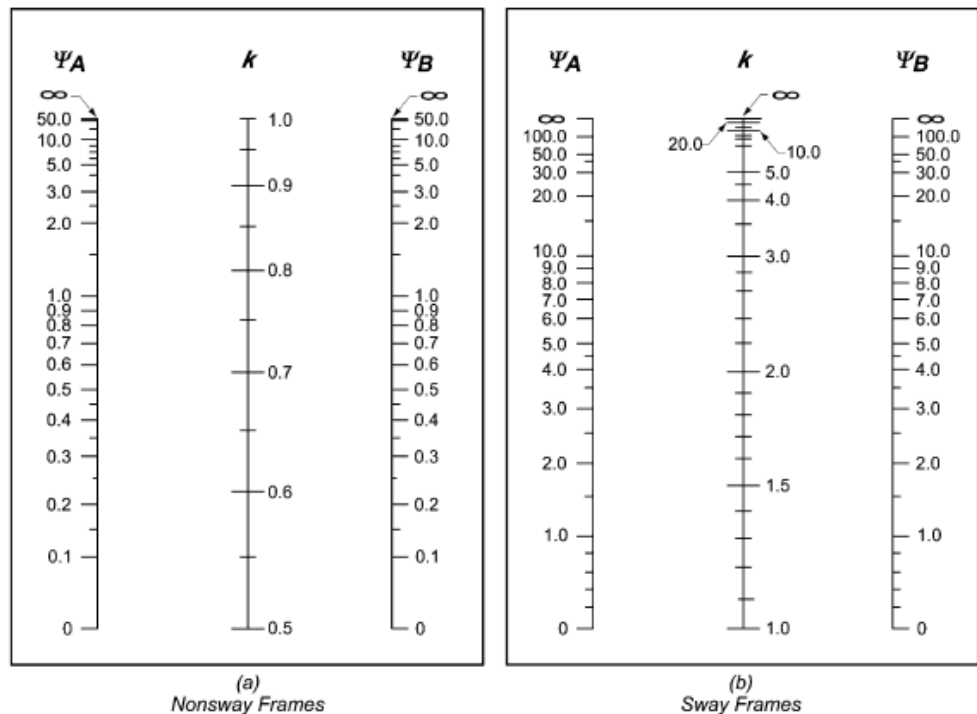
8.1 Design According to ACI 318

All equations are in customary units (in, lb).

8.1.1 Slenderness Effects in Compression Members

8.1.1.1 Effective Length

The effective length is $k \cdot \ell_u$, where ℓ_u is the unbraced length and k is the effective length factor which is defined below.



Ψ = ratio of $\Sigma(EI/\ell_c)$ of compression members to $\Sigma(EI/\ell)$ of flexural members in a plane at one end of a compression member
 ℓ = span length of flexural member measured center to center of joints

Figure 8.1: Effective length factors k acc. to Fig. R10.10.1.1

It shall be permitted to use the following properties for the members in the model:

Modulus of elasticity for normal weight concrete acc. to 8.5.1 $E_c = 57000\sqrt{f'_c}$
 f'_c concrete compressive strength

Moment of inertia I for the determination of Ψ acc. to 10.10.4.1
 for compression members - columns $0,70 I_g$
 or (if reinforcement ratio is known) for compression members

$$I = \left(0.8 + 25 \frac{A_{st}}{A_g} \right) \left(1 - \frac{M_u}{P_u h} - 0.5 \frac{P_u}{P_o} \right) \cdot I_g \leq 0.875 \cdot I_g \quad (10-8)$$

where

A_g and I_g gross cross-sectional characteristics

A_{st} total area of longitudinal reinforcement area

P_u and M_u factored forces

P_o nominal axial strength at zero eccentricity $(0.85f'_c(A_g - A_{st}) + f_y A_{st})$

When sustained lateral loads are present, the moment of inertia I shall be divided by $(1 + \beta_{ds})$ acc. to 10.10.4.2.

8.1.1.2 Slenderness

The slenderness of the column is $k \cdot \ell_u / r$, where $k \cdot \ell_u$ is the effective length and r is the ratio of gyration (in Eurocode denoted as i).

8.1.1.3 Limiting Slenderness

For compression members not braced against sidesway, the slenderness limits are for

- sway members 22 (10-6)

- nonsway members $34 - 12(M_1 / M_2) \leq 40$ (10-7)

M_1 is the smaller (in absolute values) factored end moment

M_2 is the largest (in absolute values) factored moment occurring in the member

8.1.2 Moment Magnification Procedure

8.1.2.1 Minimum Eccentricity

$$e_{z,\min} = 0.6 + 0.03h \quad (10-17)$$

h height of the member in inches

This eccentricity is not intended to be applied simultaneously about both axes. It should be used separately about each axis.

8.1.2.2 Braced Frame (Nonsway)

Magnified moment M_c :

$$M_c = \delta M_2 \quad (10-11)$$

where

M_2 the largest (in absolute values) factored moment from the first order analysis (with consideration of $e_{2,min}$)

$$\delta = C_m (1 - P_u / (0.75P_c)) \geq 1 \quad \text{moment magnifier} \quad (10-12)$$

P_u Factored axial force

$$P_c = \pi^2 EI / (k \ell_u)^2 \quad (10-13)$$

if reinforcement ratio is not known: $EI = 0.4E_c I_g / (1 + \beta_{dns})$

if reinforcement ratio is known: use moment of inertia as in equation (10-8) and $E = E_c$ and divide it by $(1 + \beta_{dns})$

I_g gross cross-sectional moment of inertia

E_c concrete modulus of elasticity

β_{dns} ratio for reduction of stiffness due to sustained axial loads

$$C_m = 0.6 + 0.4M_1/M_2 \quad (10-16)$$

M_1 smaller (in absolute values) factored end moment from 1st order analysis

M_2 largest (in absolute values) factored moment from 1st order analysis (with consideration of $e_{2,min}$)

if $M_2 < M_{2,min} = P_u e_{2,min}$ or if the column is loaded by transverse load, C_m should be 1.0

if $M_c > 1.4M_2$, the second-order effects are too high according to 10.10.2.1.

8.1.2.3 Unbraced Frame (Sway)

Magnified moment M_c :

$$M_c = \delta M_2 \quad (10-11)$$

For the calculation of the moment magnifier δ , see chapter 8.1.2.2. M_2 is the largest (in absolute values) factored moment occurring in the member (with consideration of $e_{2,min}$). M_2 and δ should be determined by using the following equations.

$$M_2 = M_{1ns} + \delta M_{1s} \quad (10-18)$$

$$M_2 = M_{2ns} + \delta M_{2s} \quad (10-19)$$

where

M_{1ns} and M_{2ns} factored moments from nonsway loading

M_{1s} and M_{2s} factored moments from sway loading

$$\delta_s = 1 / (1 - Q) \geq 1.0 \quad \text{moment magnifier} \quad (10-20)$$

Q calculated according to (10-10)

If $\delta_s \geq 1.5$, a message is shown that second-order elastic analysis or equation (10-21) should be used.

If $M_c > 1.4(M_{2ns} + M_{2s})$, the second-order effects are too high according to 10.10.2.1. There is also a corresponding message (the same as in nonsway structures).

As you can see, it is essential for the calculation how to split the loading into sway and non-sway moments.

8.1.3 Strength Analysis of Flexure and Axial Force

8.1.3.1 Basic Conditions

$$\phi M_n \geq M_u$$

$$\phi P_n \geq P_u$$

(Chap. R9.1)

where

M_n nominal flexural strength

P_n nominal axial strength

ϕM_n design flexural strength

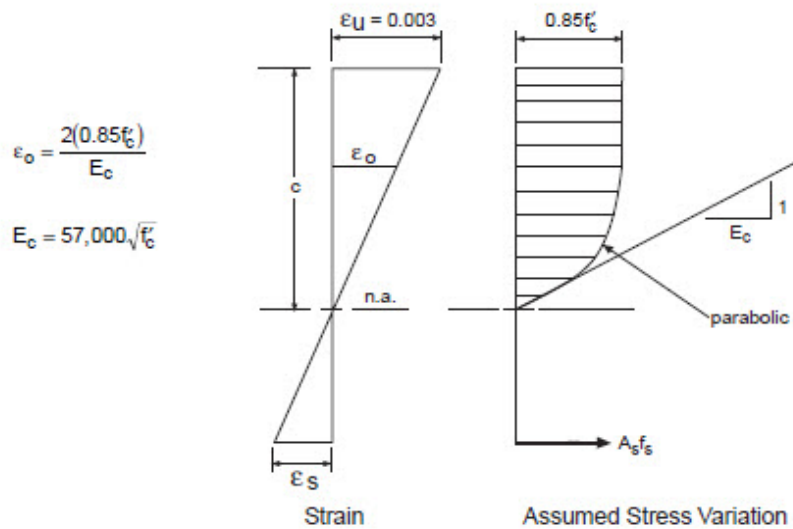
ϕP_n design axial strength

M_u factored moment

P_u factored axial force

ϕ strength reduction factor

8.1.3.2 Stress-Strain Diagrams



Concrete	Steel
$0 < \epsilon_c < \epsilon_o : f_c = 0.85f'_c \left[2 \left(\frac{\epsilon_c}{\epsilon_o} \right) - \left(\frac{\epsilon_c}{\epsilon_o} \right)^2 \right]$	$\epsilon_s \leq \epsilon_y : f_s = \epsilon_s E_s$
$\epsilon_c \geq \epsilon_o : f_c = 0.85f'_c$	$\epsilon_s > \epsilon_y : f_s = f_y$
	$E_s = 29,000,000 \text{ psi}$

Figure 8.2: Concrete stress-strain diagram

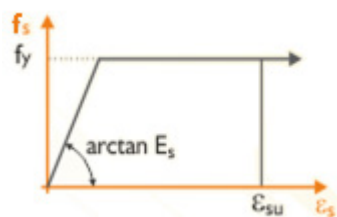


Figure 8.3: Steel stress-strain diagram

8.1.3.3 Strength Reduction Factor

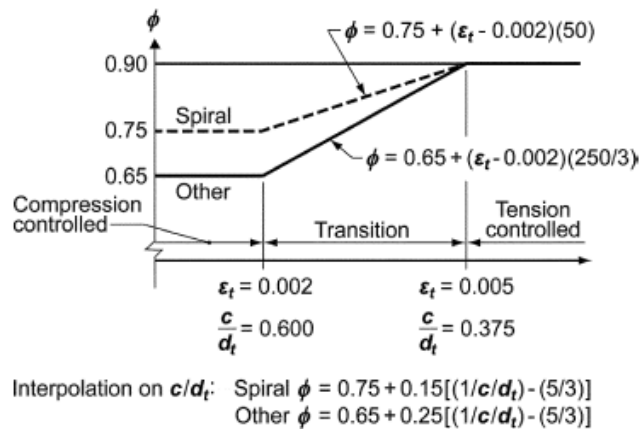


Figure 8.4: Variation of strength reduction factor acc. to Fig. R9.3.2

ϵ_t is strain in extreme tension steel.

8.1.3.4 Maximum Axial Strength

$$\phi P_{n,max} = 0.80\phi(0.85f'_c(A_g - A_{st}) + f_y A_{st}) \tag{10-2}$$

where

- ϕ strength reduction factor
- f'_c concrete compressive strength
- f_y yield strength of reinforcement
- A_g gross cross-sectional area
- A_{st} area of total longitudinal reinforcement

8.1.4 Minimum Reinforcement

$$A_{st,min} = 0.01A_g \tag{Chap. 10.9.1}$$

where

- $A_{st,min}$ minimum TOTAL reinforcement
- A_g gross cross-sectional area

8.1.5 Maximum Reinforcement

$$A_{st,max} = 0.08A_g \tag{Chap. 10.9.1}$$

where

- $A_{st,max}$ maximum TOTAL reinforcement
- A_g gross cross-sectional area

8.1.6 Shear Design

8.1.6.1 Basic Equation

$$\phi_v V_n \geq V_u \quad (11-1)$$

where

- $\phi_v = 0.75$ strength reduction factor for shear
- V_u factored shear force
- $V_n = V_c + V_s$ nominal shear strength

8.1.6.2 Shear Strength Provided by Concrete

Shear strength provided by concrete acc. to 11.2.1 for members subject to shear and **flexure** only:

$$V_c = 2\lambda\sqrt{f'_c}b_wd \quad (11-3)$$

where

- λ lightweight concrete modification factor
- f'_c concrete compressive strength, $\sqrt{f'_c} \leq 100$ psi
- b_w width of member
- d effective depth

Alternatively, a more detailed calculation can be made acc. 11.2.2 to determine the concrete shear strength:

$$V_c = (1.9\lambda\sqrt{f'_c} + 2500\rho_wdV_u/M_u) b_wd \leq 3.5\lambda\sqrt{f'_c}b_wd \quad (11-5)$$

where

- M_u, V_u factored forces
- $\rho_w = A_s / (b_wd)$ reinforcement ratio
- b_w width of member
- d effective depth
- A_g gross cross-sectional area
- A_s area of longitudinal reinforcement
- λ lightweight concrete modification factor
- f'_c concrete compressive strength, $\sqrt{f'_c} \leq 100$ psi
- $V_u d / M_u \leq 1.0$

Shear strength provided by concrete acc. to 11.2.1 for members subject to **axial compression**:

$$V_c = 2(1 + N_u / (2000A_g))\lambda\sqrt{f'_c}b_wd \quad (11-4)$$

where

- N_u factored axial force
- A_g gross cross-sectional area
- λ lightweight concrete modification factor
- f'_c concrete compressive strength, $\sqrt{f'_c} \leq 100$ psi
- b_w width of member
- d effective depth

Alternatively, the shear strength provided by concrete with axial compression can be calculated acc. to 11.2.2. The following equation applies for $M_m \geq 0$ (M_m is defined below):

$$V_c = (1.9\lambda\sqrt{f'_c} + 2500\rho_w V_u d / M_m) b_w d \leq 3.5\lambda\sqrt{f'_c} b_w d \sqrt{1 + N_u / (500A_g)} \quad (11-5)$$

Otherwise the following equation is to be used:

$$V_c = 3.5\lambda\sqrt{f'_c} b_w d \sqrt{1 + N_u / (500A_g)} \quad (11-7)$$

The parameters in those equations are:

$$M_m = M_u - N_u (4h - d) / 8$$

M_u, N_u, V_u	factored forces
$\rho_w = A_s / (b_w d)$	reinforcement ratio
h	height of member
b_w	width of member
d	effective depth
A_g	gross cross-sectional area
A_s	area of longitudinal reinforcement
λ	lightweight concrete modification factor
f'_c	concrete compressive strength, $\sqrt{f'_c} \leq 100$ psi

Shear strength provided by concrete acc. to 11.2.1 for members with significant **axial tension**:

$$V_c = 0$$

Alternatively, shear strength provided by concrete with significant axial tension can be calculated acc. to 11.2.2:

$$V_c = 2(1 + N_u / (500A_g))\lambda\sqrt{f'_c} b_w d \geq 0 \quad (11-8)$$

where

N_u	factored forces
b_w	width of member
d	effective depth
A_g	gross cross-sectional area
λ	lightweight concrete modification factor
f'_c	concrete compressive strength, $\sqrt{f'_c} \leq 100$ psi

8.1.6.3 Shear Strength Provided by Shear Reinforcement

$$V_s = A_v f_{yt} d / s \leq 8\lambda\sqrt{f'_c} b_w d \quad (11-15)$$

where

A_v	total cross-sectional area of web reinforcement within distance s
d	effective depth of bending reinforcement
s	longitudinal spacing of web reinforcement
f_{yt}	yield strength of web steel

Minimum area of shear reinforcement:

$$A_{v,min} = 0.75\sqrt{f'_c} b_w s / f_{yt} \geq 50b_w s / f_{yt} \quad (11-13)$$

where

f'_c	concrete compressive strength, $\sqrt{f'_c} \leq 100$ psi
b_w	width of member
s	longitudinal spacing of web reinforcement
f_{yt}	yield strength of web steel

The minimum shear reinforcement is required where $V_u > 0.5\phi V_c$ – except in members with $h \leq 10$ in. acc. to 11.4.6.1.

8.1.7 Construction Requirements

8.1.7.1 Ties and Stirrups

When shear reinforcement is required ($V_u > 0.5\phi V_c$, except in members with $h \leq 10$ in.), the minimum spacing of shear reinforcement should satisfy the requirements acc. to 11.4.5:

$$s < d/2 \text{ and } s < 24 \text{ in. for } V_s \leq 4\sqrt{f'_c}b_wd$$

$$s < d/4 \text{ and } s < 12 \text{ in. for } V_s > 4\sqrt{f'_c}b_wd$$

When compression reinforcement is required (as usual for columns), the ties shall conform to the following:

Size of the transverse ties shall be acc. to 7.10.5.1 at least:

No. 3 ($d_s = 0.375$ in.) for longitudinal bars No. 10 ($d_s = 1.270$ in.) or smaller

No. 4 ($d_s = 0.500$ in.) for longitudinal bars No. 11, No. 14, No. 18 ($d_s \geq 1.410$ in.)

Spacing of the transverse ties acc. to 7.10.5.2 shall not exceed

- 16 longitudinal bars diameters,
- 48 tie bar or wire diameters, or
- the least dimension of compression member.

8.1.7.2 Longitudinal Reinforcement

Minimum number of longitudinal bars in compression members shall be 4 for bars within rectangular or circular ties acc. to 10.9.2.

In compression members, the clear distance between longitudinal bars shall be not less than $1.5d_b$ nor less than 1.5 in. acc. to 7.6.3.

d_b diameter of bar

8.1.7.3 Development of the Reinforcement

$$l_d = \left(\frac{3}{40} \frac{f_y}{\lambda \sqrt{f'_c}} \frac{\Psi_t \Psi_e \Psi_s}{c_b + K_{tr}} \right) \cdot d_b \quad (12-1)$$

where

f_y	yield strength of reinforcement
f'_c	concrete compressive strength, $\sqrt{f'_c} \leq 100$ psi
c_b	smaller of minimum cover or one-half of bar spacing measured to center of bar
d_b	diameter of bar
λ	lightweight concrete modification factor
$K_{tr} = 40A_{tr}/s_n$	transverse reinforcement index
A_{tr}	total cross-sectional area of all transverse reinforcement within the spacing s that crosses the potential plane of splitting through the reinforcement being developed
s	spacing of transverse reinforcement
n	number of bars developed or spliced at the same location
Ψ_t	reinforcement location factor
Ψ_e	coating factor
Ψ_s	reinforcement size factor
$(c_b + K_{tr}) / d_b \leq 2.5$	

It may be multiplied by $A_{s,required} / A_{s,provided}$.

The development length of tension reinforcement shall not be less than 12 in.

Development of **compression bars**:

$$\ell_{dc} = 0.02f_y / (\lambda\sqrt{f'_c})d_b \geq 0.0003f_yd_b \tag{12.3.2}$$

where

- f_y yield strength of the reinforcement
- f'_c concrete compressive strength, $\sqrt{f'_c} \leq 100$ psi
- d_b diameter of bar
- λ lightweight concrete modification factor

It may be multiplied by $A_{s,required} / A_{s,provided}$.

The development length of compression reinforcement shall not be less than 8 in. acc. to 12.3.1.

Development of **standard hooks**:

$$\ell_{dh} = 0.02\Psi_e f_y / (\lambda\sqrt{f'_c})d_b \tag{12.5.2}$$

where

- f_y yield strength of the reinforcement
- f'_c concrete compressive strength, $\sqrt{f'_c} \leq 100$ psi
- d_b diameter of bar
- λ lightweight concrete modification factor
- Ψ_e coating factor

Hooks shall not be considered effective in developing bars in compression.

It may be multiplied by $A_{s,required} / A_{s,provided}$.

The development length of standard hooks shall not be less than $8d_b$ and 6 in.

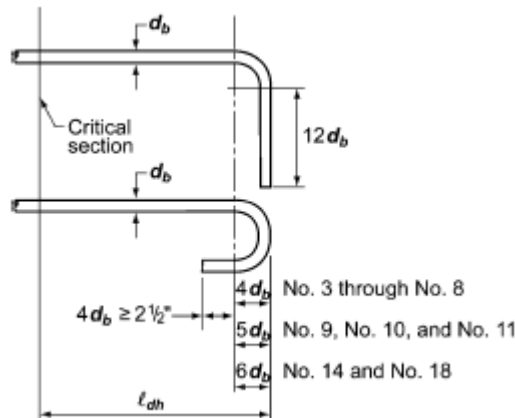


Figure 8.5: Hooked bar details of "standard hook" acc. to Fig. R12.5

Development of **welded wires** in tension (with transverse bars):

The development length ℓ_d calculated acc. to previous chapters (eg. (12-1 or 12.5.2) is to be multiplied by the welded deformed wire reinforcement factor Ψ_w .

$$\Psi_w = (f_y - 35000) / f_y \geq 5d_b / s$$

$$\Psi_w \leq 1.0 \tag{12.7.2}$$

It may be multiplied by $A_{s,required} / A_{s,provided}$.

The development length of welded wires shall not be less than 8 in.

Splices (overlap) in tension:

$\frac{A_s \text{ provided}^*}{A_s \text{ required}}$	Maximum percent of A_s spliced within required lap length	
	50	100
Equal to or greater than 2	Class A	Class B
Less than 2	Class B	Class B

*Ratio of area of reinforcement provided to area of reinforcement required by analysis at splice locations.

Figure 8.6: Classes for tension lap acc. to Tab. R12.15.2

The basic equation is the same as for straight tension bars (12-1), but without multiplier $A_{s,required} / A_{s,provided}$ and without 12 in. limit.

This value should be multiplied by the coefficient acc. to the class of the splice. The final value shall be not less than 12 in. The division into the classes can be seen in Figure 8.6.

Class A splice: $1.0l_d$

Class B splice: $1.3l_d$

Splices (overlap) in compression:

- for $f_y \leq 60000$ psi $l_{dc} = 0.0005f_y d_b \geq 12$ in.

- for $f_y > 60000$ psi $l_{dc} = (0.0009f_y - 24)d_b \geq 12$ in.

If $f'_c < 3000$ psi, then l_{dc} shall be multiplied by 4/3.

If ties have an effective area not less than $0.0015 h_s$, splice length may be multiplied by 0.83, but the final value shall be not less than 12 in.

8.1.7.4 Factors for Development Length

	Reinforcement location factor Ψ_t
	Vertical reinforcement
Straight bars	1.0

	Coating factor Ψ_e		
	Epoxy-coated		Other
	cover $< 3d_b$ or spacing $< 6d_b$	Other	
Straight bars	1.5	1.2	1.0
Hooks	1.2	1.2	1.0
Heads	1.2	1.2	1.0

	Reinforcement size factor Ψ_s	
	No. 6 and smaller	No. 7 and larger
Straight bars	0.8	1.0

Figure 8.7: Factors Ψ for development length acc. to ACI 318-11

8.2 Data Input for ACI 318-11

This chapter provides specific information concerning the data input for the design according to ACI 318-11.

Units and Decimal Places

The U.S. code is available in imperial (ACI 318) or in metric (ACI 318M) units, and also the calculation can be run with both units settings. It is possible to change the units at any time.

An easy way to change units is to right-click the model name in the *Data* navigator and to open the dialog box *Units and Decimal Places*. The current settings can be checked for RSTAB and for the module CONCRETE Columns. You can change the global settings from metric to imperial units and back by the *Load Profile* dialog box.

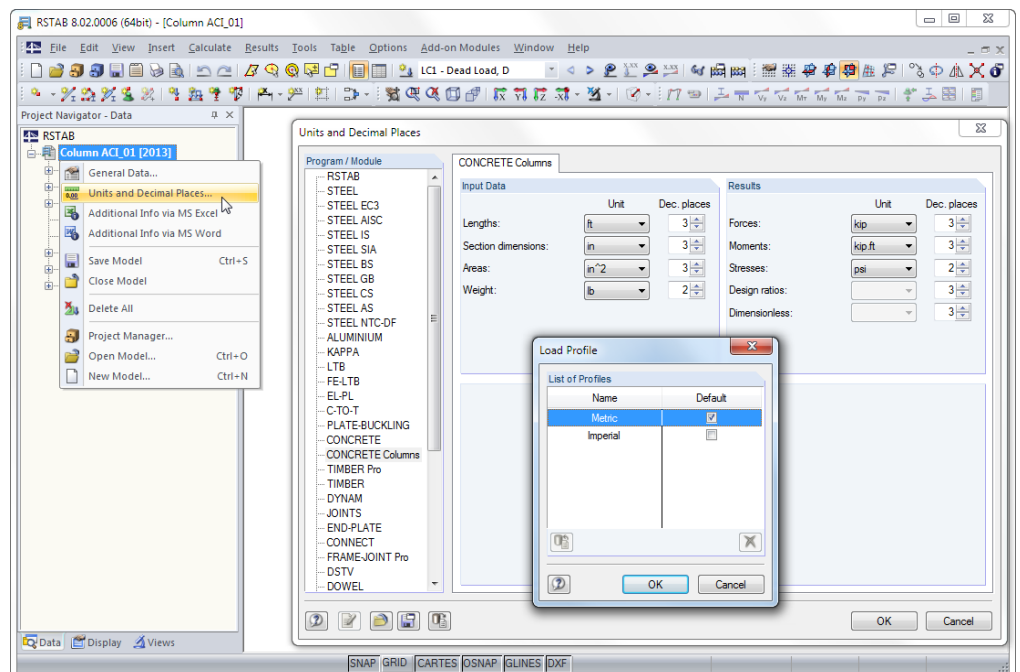


Figure 8.8: Units and decimal places, load profiles in RSTAB

For the design of the column, it is important to know how to split the actions into sway and nonsway loading and, thus, to prepare the load combinations correctly.

Open the context menu of a load combination by right-clicking it.

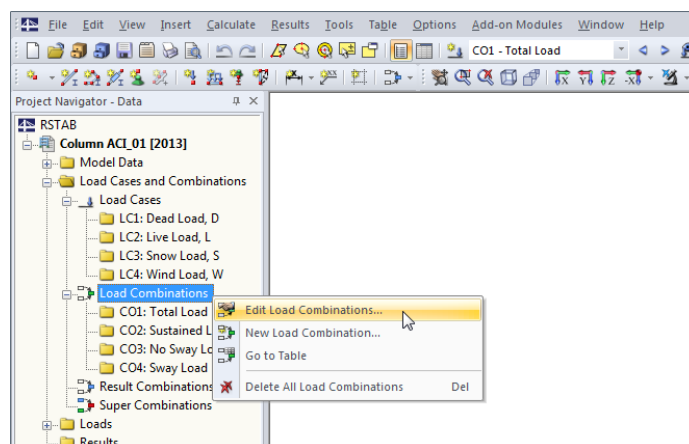


Figure 8.9: Context menu to edit load combination

The dialog box *Edit Load Cases and Combinations* is opened.

In the *Load Combinations* tab, there are three main sections: *Existing Load Combinations*, *Existing Load Cases* and *Load Cases in Load Combination*.

For the following example, four load combinations have been created: Total Load, Sustained Load, No Sway Load and Sway Load.

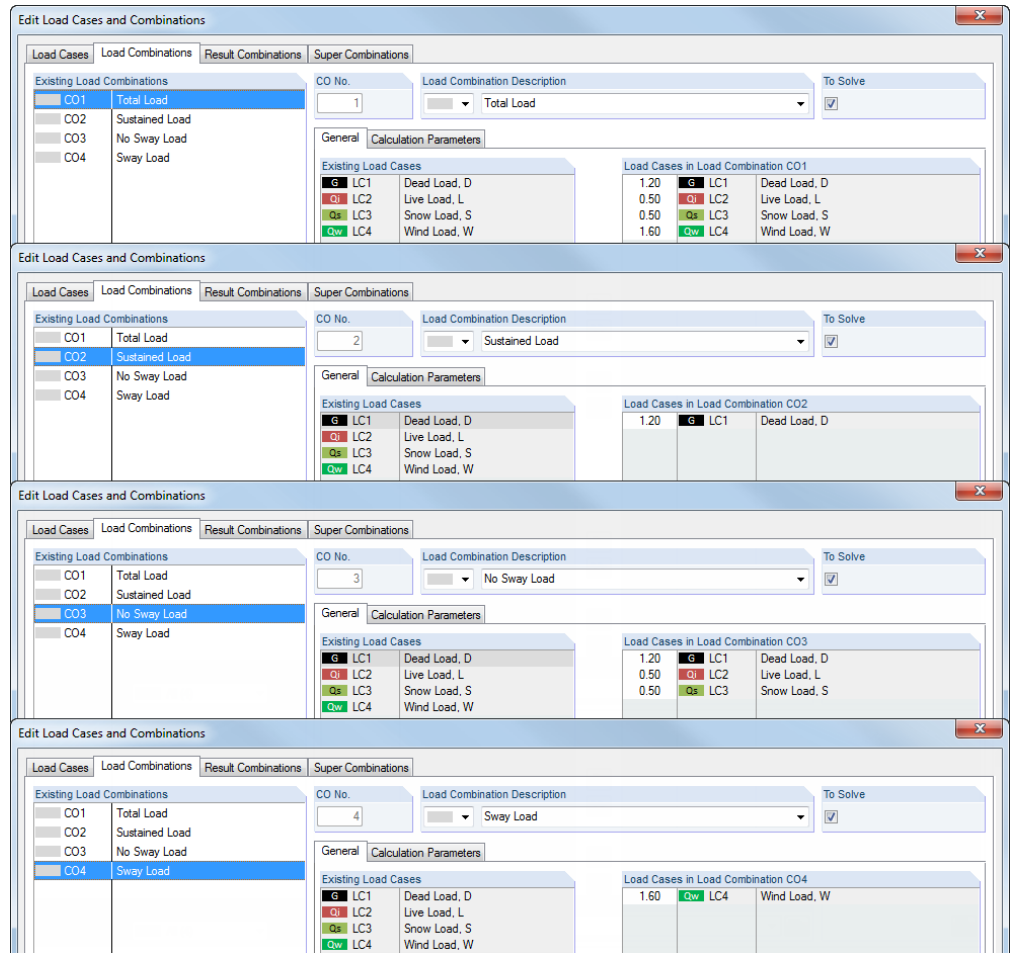


Figure 8.10: Definition criteria of four different load combinations

Start of the module CONCRETE Columns. In the *General Data* window, select load combination CO1 *Total Load* for the Strength Limit State design. Then go to the third tab and select CO4 *Sway Load* (see Figure 8.12). Return to the first tab and allocate CO4 by choosing this option from the list. This list is accessible via the [▼] button which appears when clicking the cell.

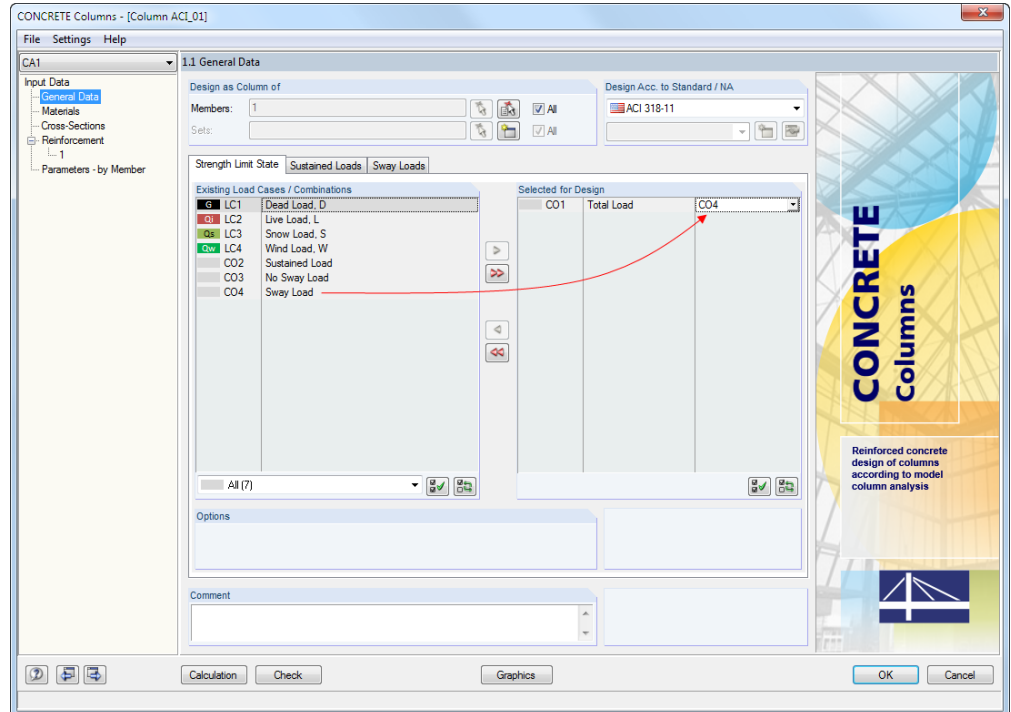


Figure 8.11: Window 1.1 *General Data*, tab *Strength Limit State* – selecting CO1 *Total Load* and allocating CO4 *Sway Load*

The third tab contains the selected *Sway Load* combination CO4.

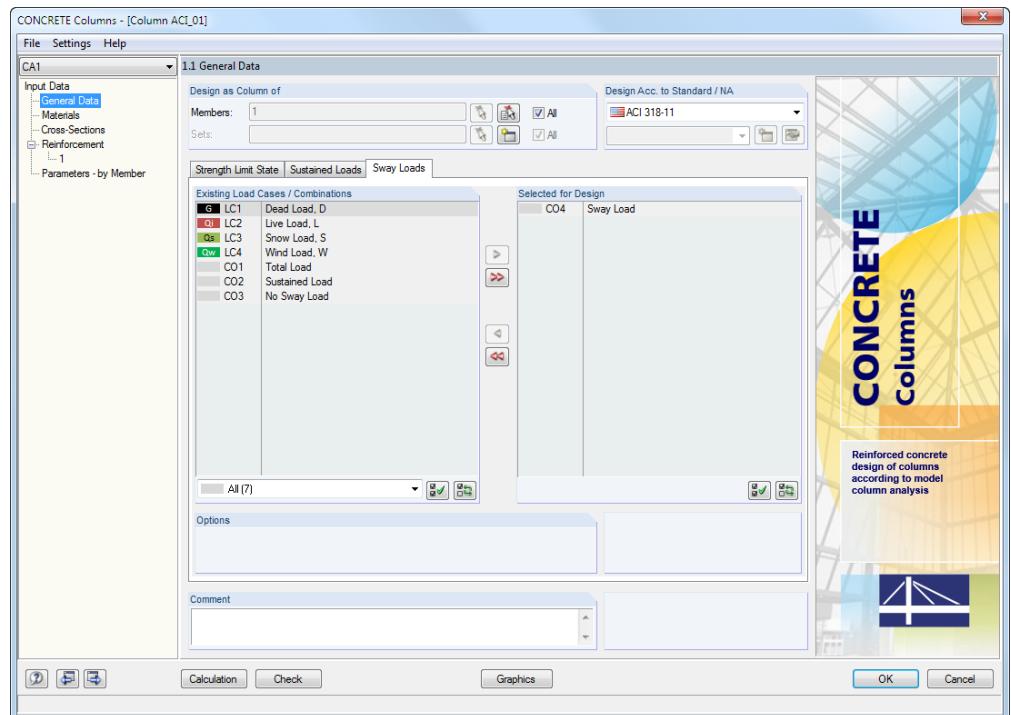


Figure 8.12: Window 1.1 *General Data*, tab *Sway Loads* – selecting CO4 *Sway Load*

In the second tab, select combination CO2 Sustained Load for the design.

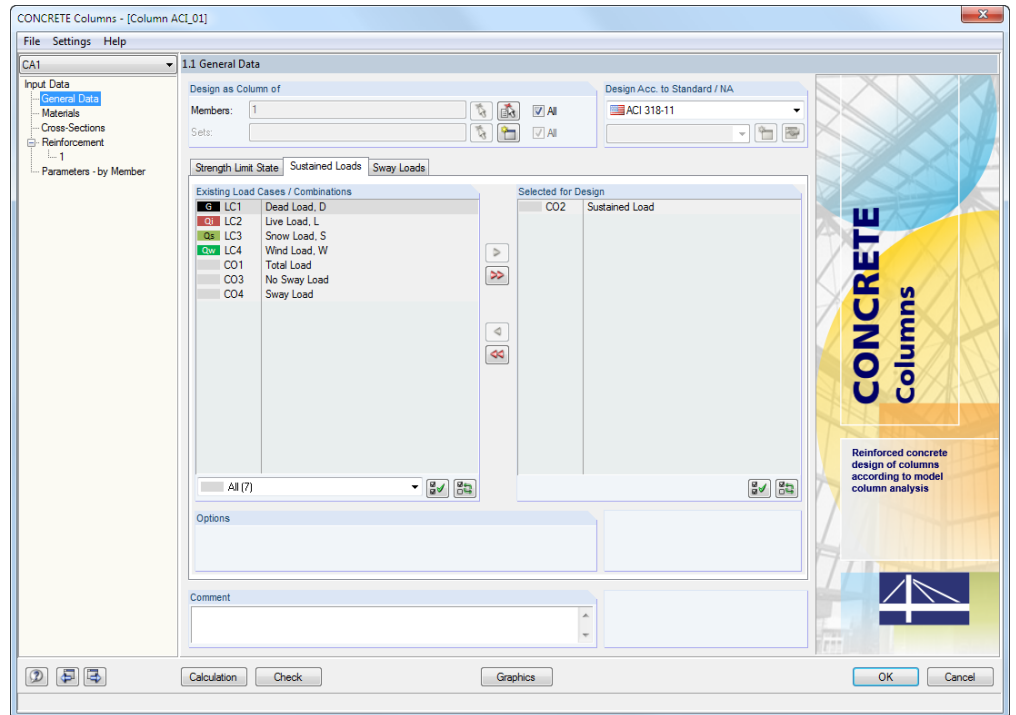


Figure 8.13: Window 1.1 General Data, tab Sway Loads – selecting CO2 Sustained Load

In the next window 1.2 Materials, check if the materials according to ACI are set.

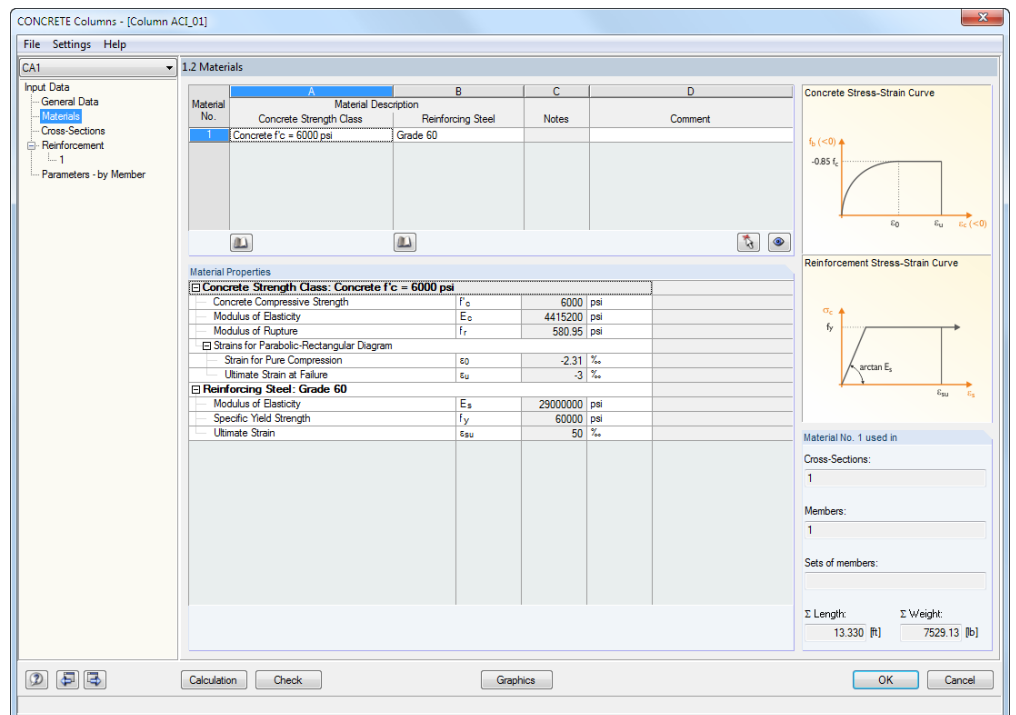


Figure 8.14: Window 1.2 Materials

In window 1.4 *Reinforcement*, the bars of the longitudinal reinforcement are to be defined.

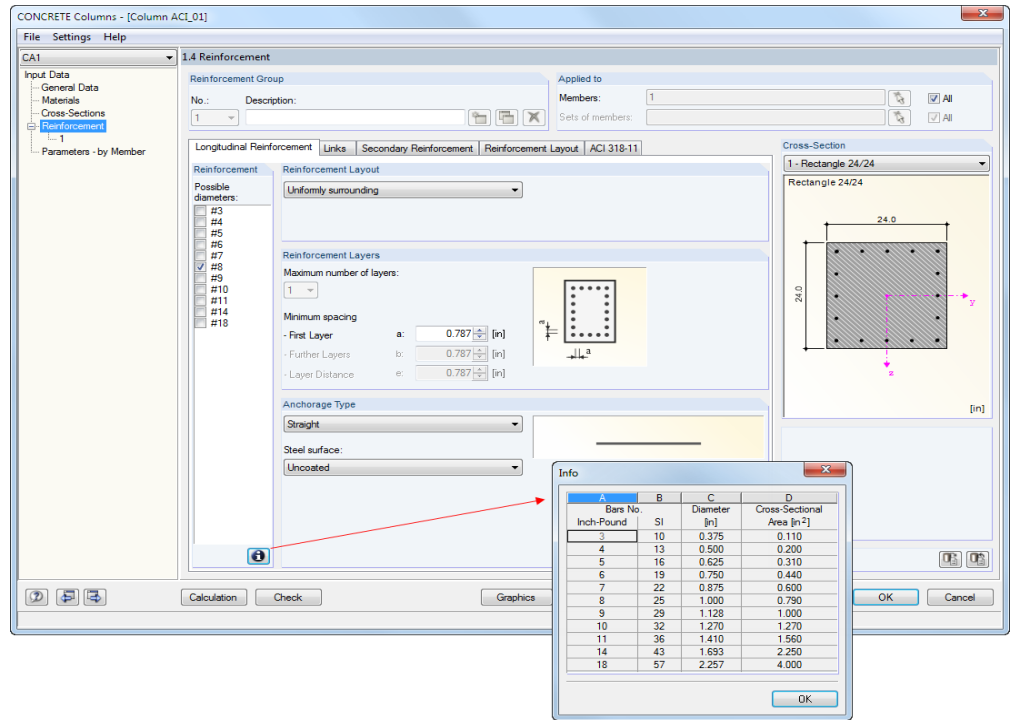


Figure 8.15: Window 1.4 *Reinforcement*, tab *Longitudinal Reinforcement*

The diameters can be checked in imperial and metric units.

The second tab *Links* has a similar layout where you can select the bars for the stirrups.

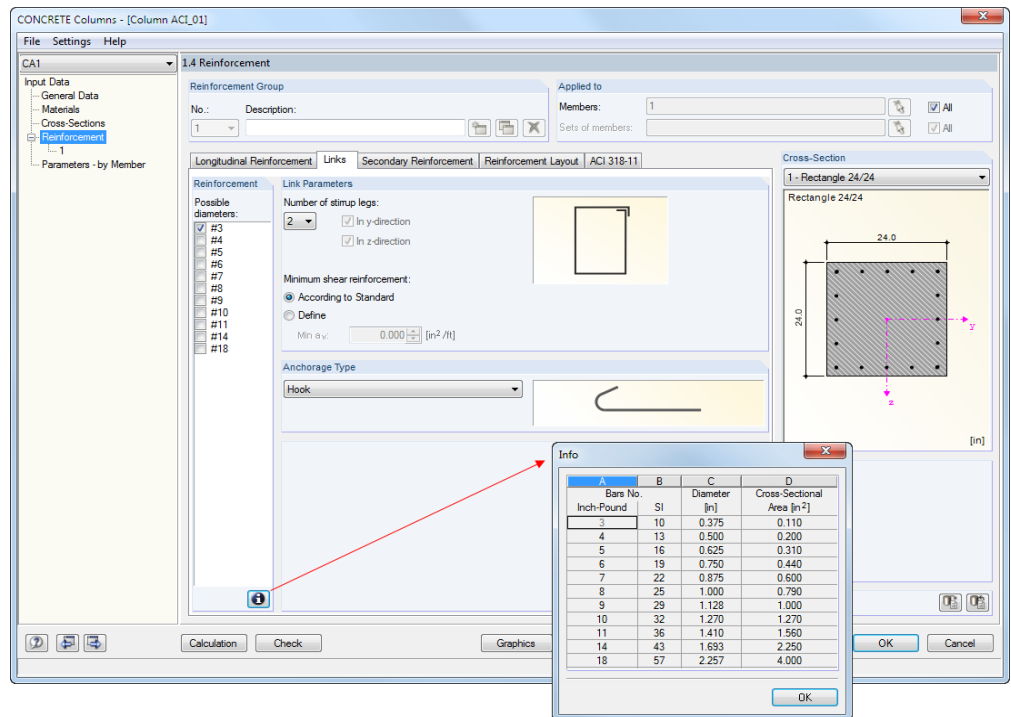


Figure 8.16: Window 1.4 *Reinforcement*, tab *Links*

The last tab of window 1.4 *Reinforcement* controls the parameters that are relevant for ACI 318.

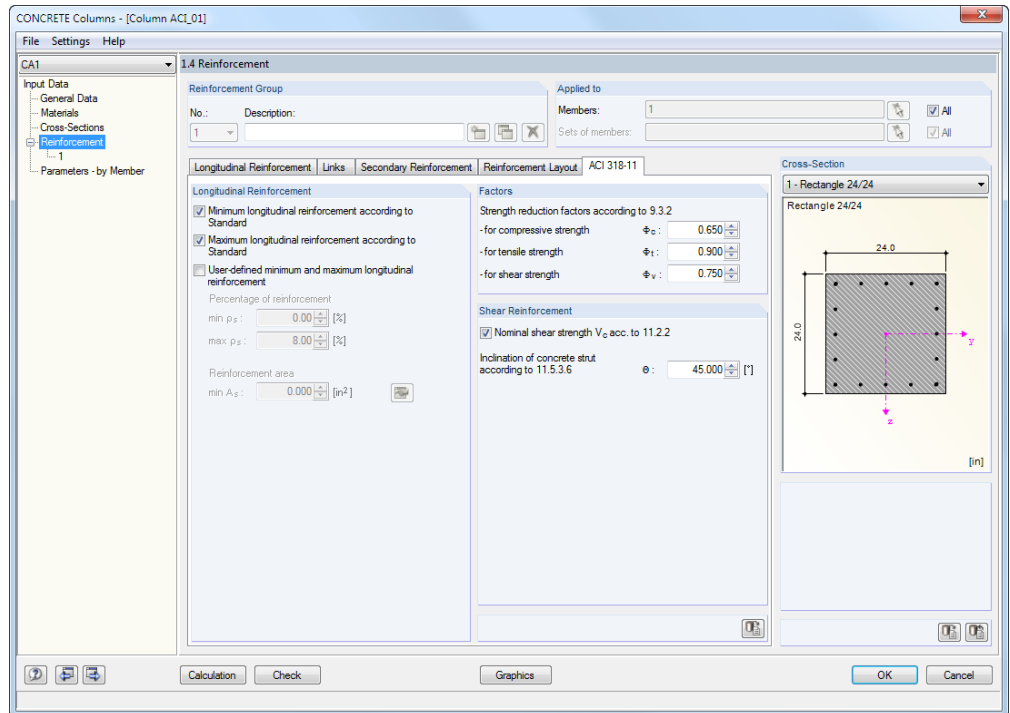


Figure 8.17: Window 1.4 *Reinforcement*, tab *ACI 318-11*

Start the [Calculation] to determine the required reinforcement. In the results windows, the intermediate results are shown as well.

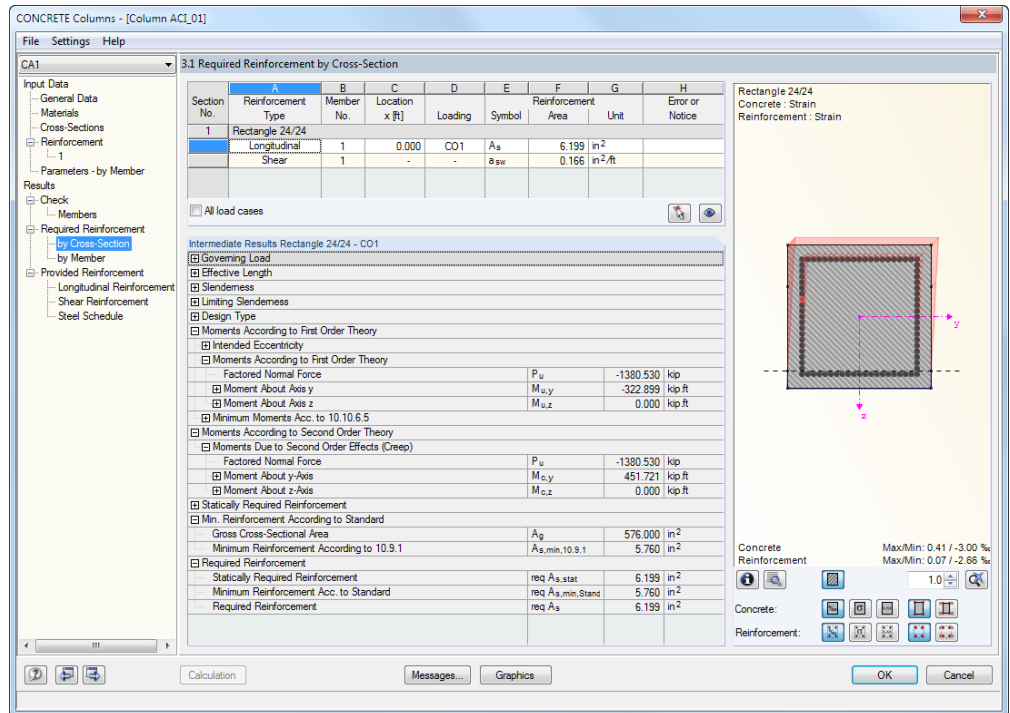


Figure 8.18: Window 3.1 *Required Reinforcement by Cross-Section* with list of intermediate results

The provided reinforcement can also be displayed graphically.

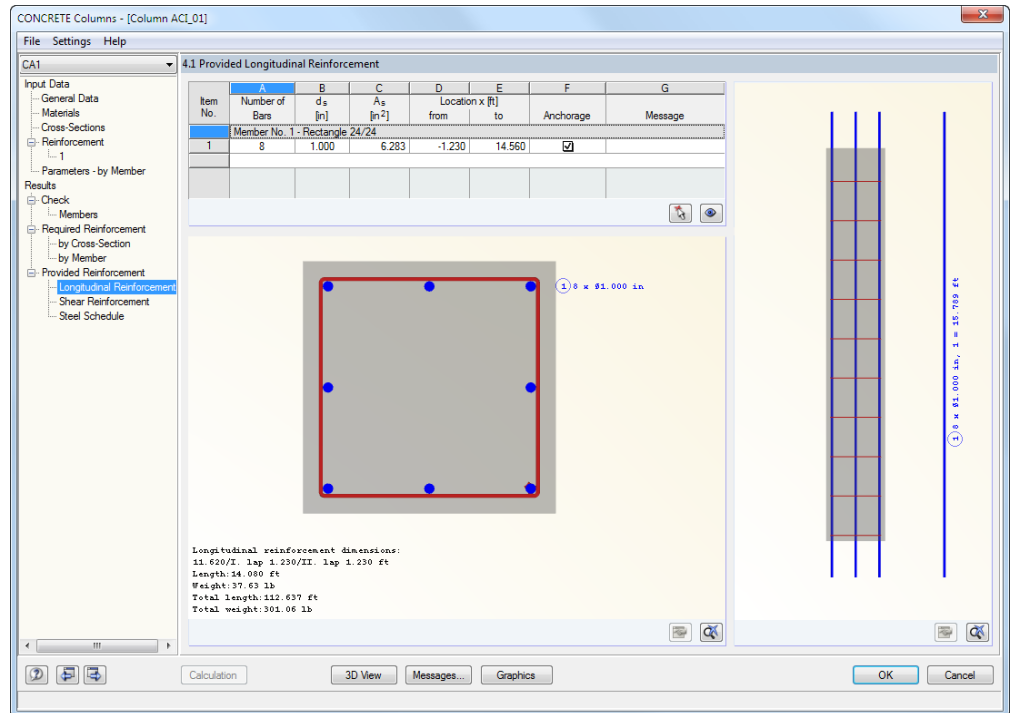


Figure 8.19: Window 4.1 Provided Longitudinal Reinforcement

A: Literature

- [1] ACI 318-11: Building Code Requirements for Structural Concrete (ACI 318-11) and Commentary, ACI Committee 318, August 2011
- [2] EN 1992-1-1:2005 + AC:2010 : Design of Concrete Structures – Part 1-1 : General Rules and Rules for Buildings. 2005
- [3] EN 1992-1-2:2005: Design of Concrete Structures – Part 1-2: General Rules – Structural Fire Design. 2006
- [4] HOSSER, D. und RICHTER, E.: Überführung von EN 1992-1-2 in EN-Norm und Bestimmung der national festzulegenden Parameter (NDP) im Nationalen Anhang zu EN 1992-1-2. Schlussbericht, Stuttgart, Fraunhofer IRB 2007